

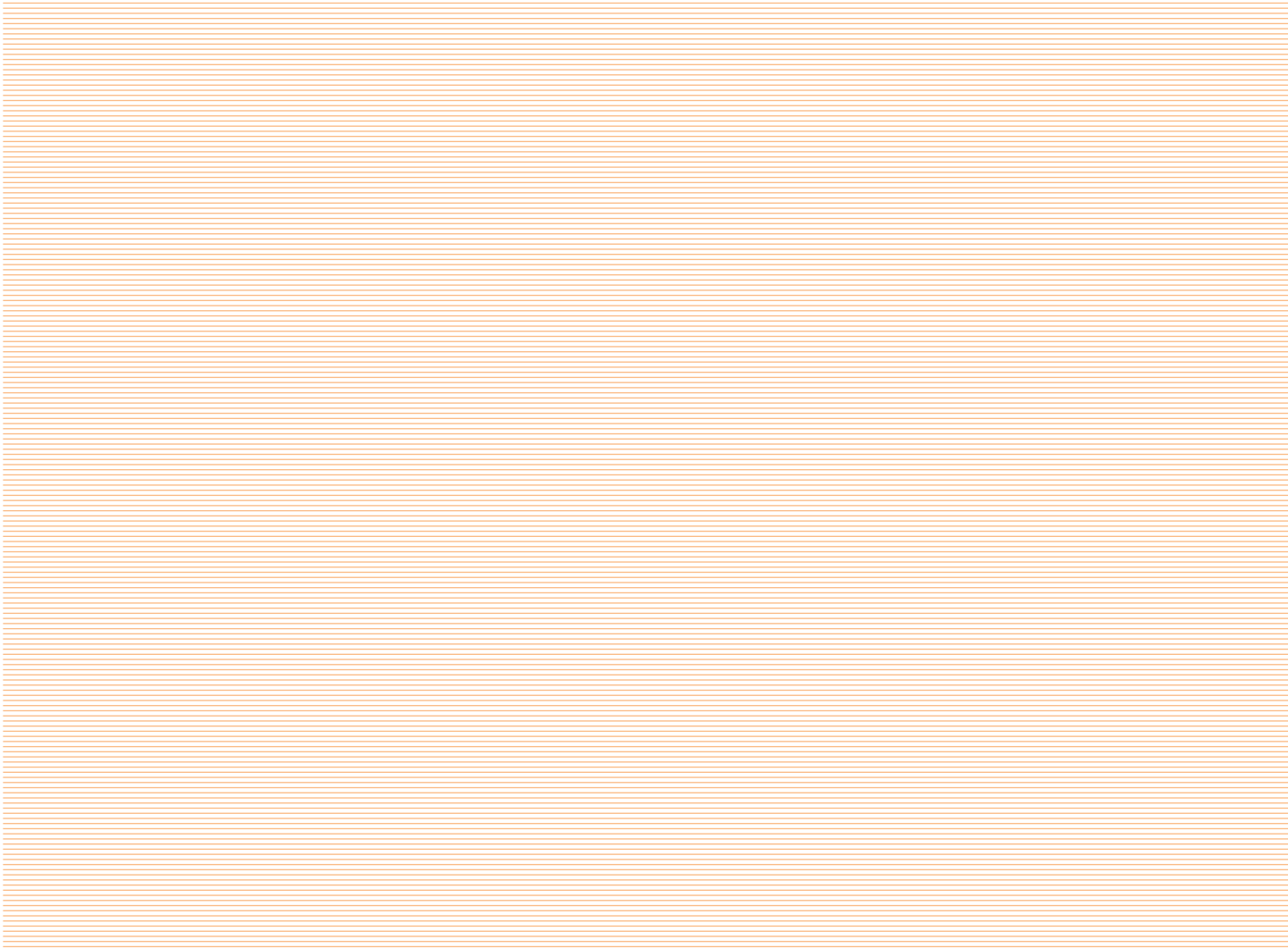

10

EXPLORERS

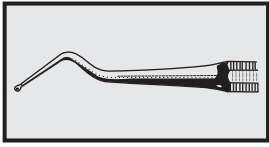



Probes & Explorers





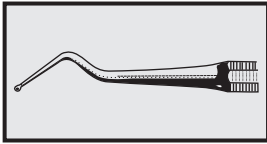

SCHWERER MODELL





DC34-003-01
Nerve Probe



Probes & Explorers

				
	1/1	1/1	1/1	1/1
	1	2	3	4
A	DC34-005-01	DC34-005-02	DC34-005-03	DC34-005-04
B	DC34-007-01	DC34-007-02	DC34-007-03	DC34-007-04

				
	1/1	1/1	1/1	1/1
	5	5a	6	6a
A	DC34-005-05	DC34-005-55	DC34-005-06	DC34-005-66
B	DC34-007-05	DC34-007-55	DC34-007-06	DC34-007-66

				
	1/1	1/1	1/1	1/1
	7	8	8a	9
A	DC34-005-07	DC34-005-08	DC34-005-88	DC34-005-09
B	DC34-007-07	DC34-007-08	DC34-007-88	DC34-007-09

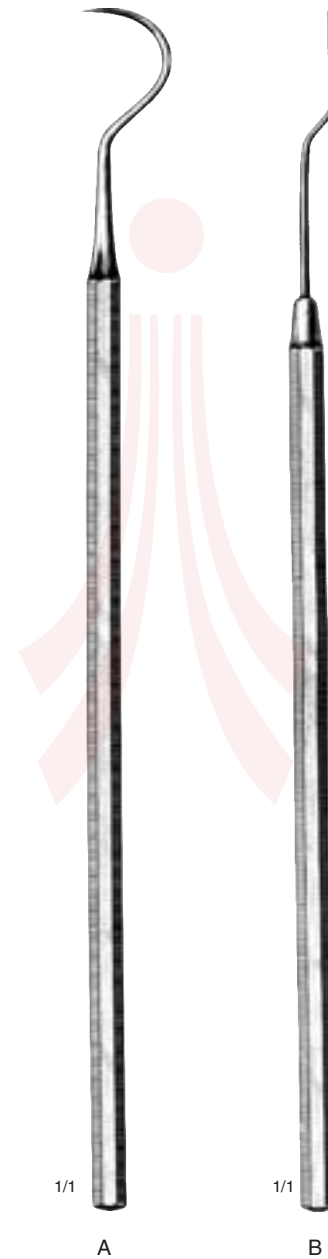

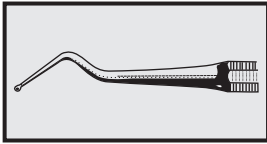

Probes & Explorers

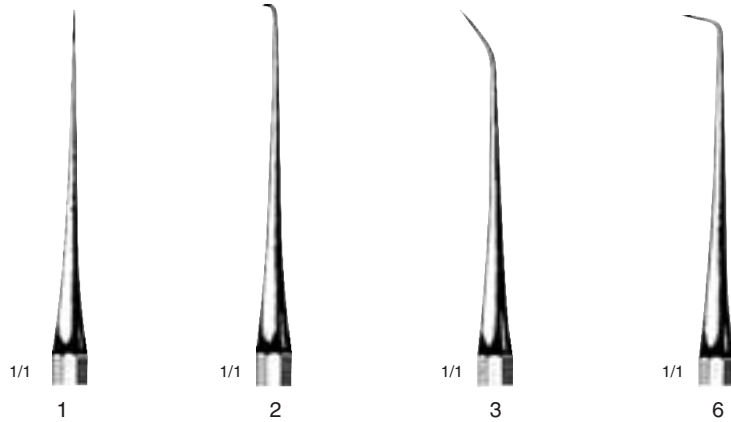

White

A	DC34-009-01	DC34-009-02	DC34-009-03	DC34-009-06
B	DC34-011-01	DC34-011-02	DC34-011-03	DC34-011-06
C	DC34-013-01	DC34-013-02	DC34-013-03	DC34-013-06

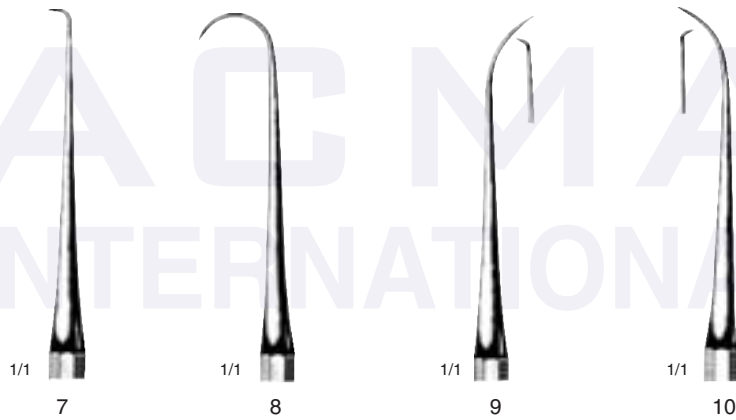

White

A	DC34-009-07	DC34-009-08	DC34-009-09	DC34-009-10
B	DC34-011-07	DC34-011-08	DC34-011-09	DC34-011-10
C	DC34-013-07	DC34-013-08	DC34-013-09	DC34-013-10

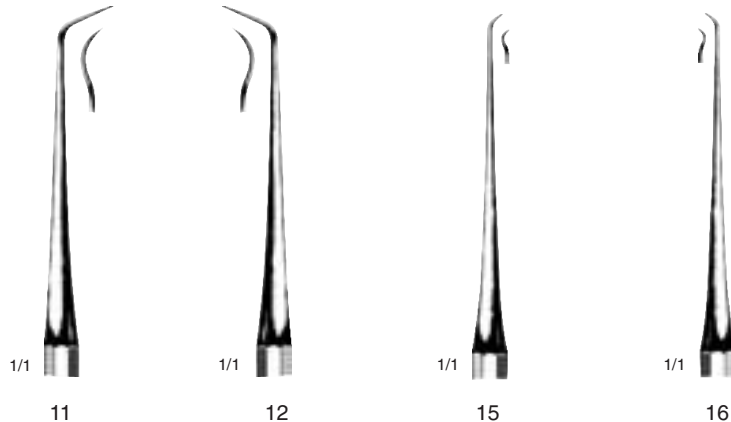

White

A	DC34-009-11	DC34-009-12	DC34-009-15	DC34-009-16
B	DC34-011-11	DC34-011-12	DC34-011-15	DC34-011-16
C	DC34-013-11	DC34-013-12	DC34-013-15	DC34-013-16

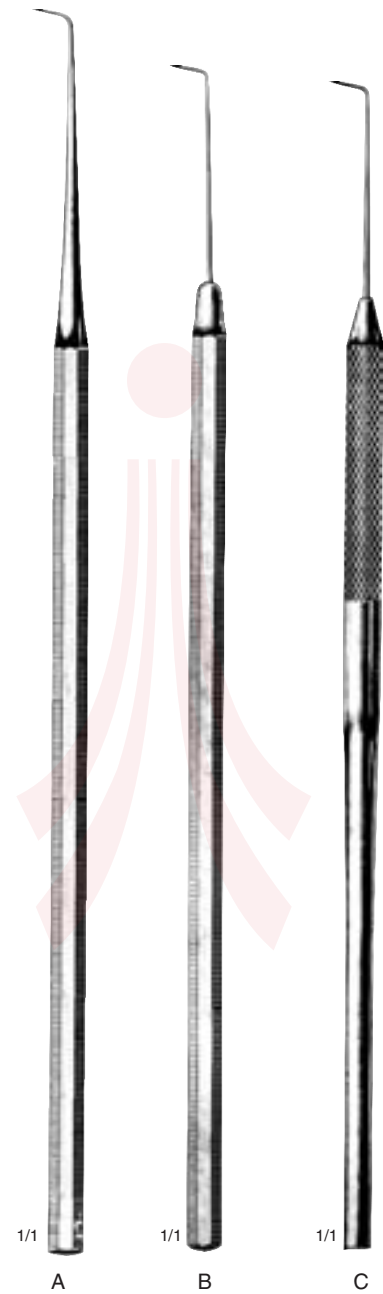

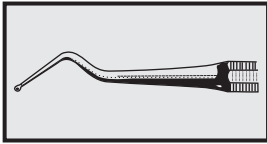

Probes & Explorers

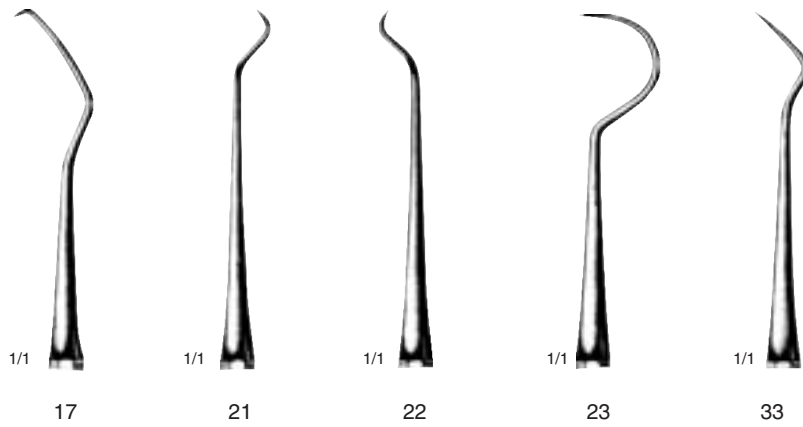

	White				
A	DC34-015-17	DC34-015-21	DC34-015-22	DC34-015-23	DC34-015-33
B	DC34-016-17	DC34-016-21	DC34-016-22	DC34-016-23	DC34-016-33
C	DC34-017-17	DC34-017-21	DC34-017-22	DC34-017-23	DC34-017-33

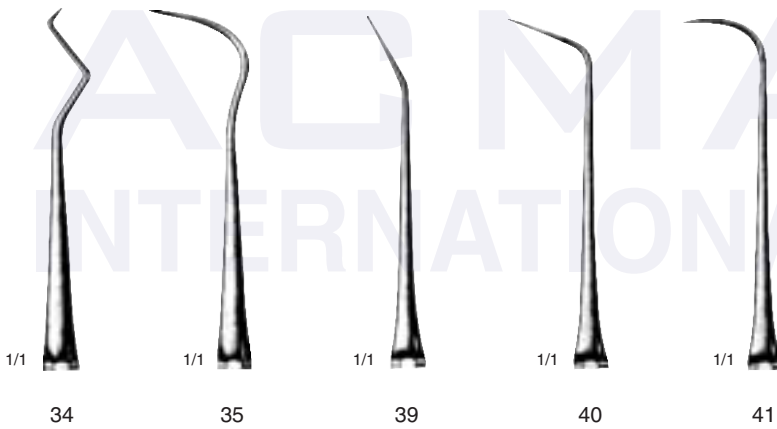

	White				
A	DC34-015-34	DC34-015-35	DC34-015-39	DC34-015-40	DC34-015-41
B	DC34-016-34	DC34-016-35	DC34-016-39	DC34-016-40	DC34-016-41
C	DC34-017-34	DC34-017-35	DC34-017-39	DC34-017-40	DC34-017-41

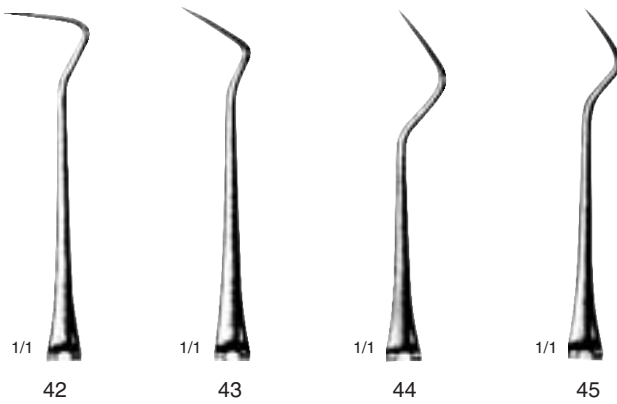

	White			
A	DC34-015-42	DC34-015-43	DC34-015-44	DC34-015-45
B	DC34-016-42	DC34-016-43	DC34-016-44	DC34-016-45
C	DC34-017-42	DC34-017-43	DC34-017-44	DC34-017-45

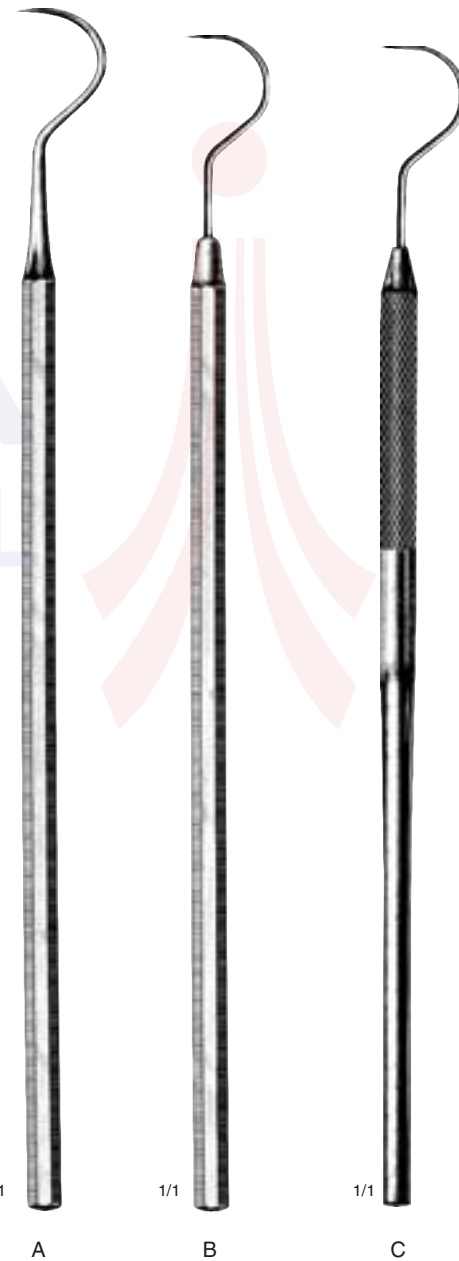

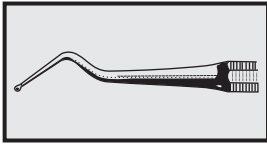

Probes & Explorers



A	DC34-018-02	DC34-018-03	DC34-018-05	DC34-018-06
B	DC34-019-02	DC34-019-03	DC34-019-05	DC34-019-06
C	DC34-020-02	DC34-020-03	DC34-020-05	DC34-020-06

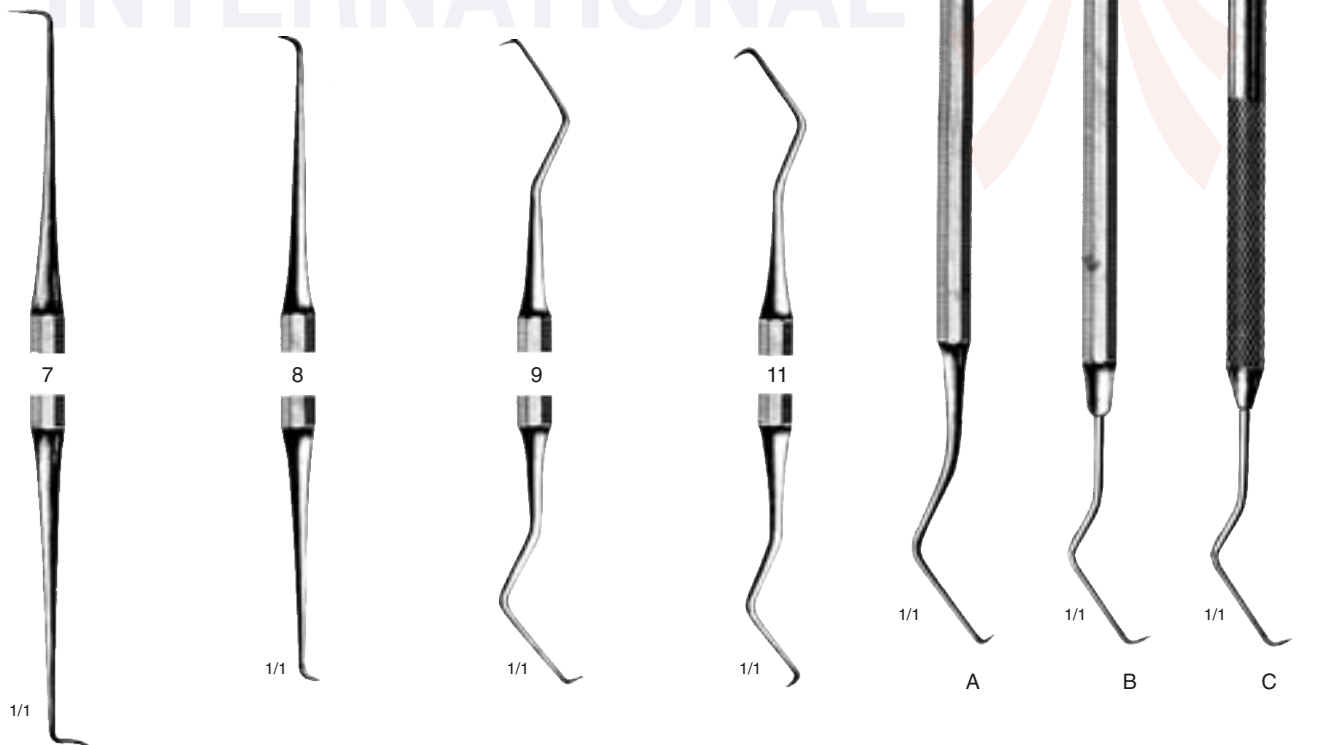

A	DC34-018-07	DC34-018-08	DC34-018-09	DC34-018-11
B	DC34-019-07	DC34-019-08	DC34-019-09	DC34-019-11
C	DC34-020-07	DC34-020-08	DC34-020-09	DC34-020-11

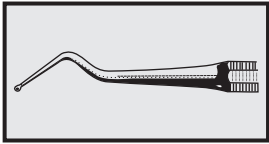

Probes & Explorers



Lange
DC34-021-01

Lange
DC34-021-02

Weston
DC34-023-01

Weston
DC34-025-01

DC34-027-01

DC34-027-02

DC34-027-03

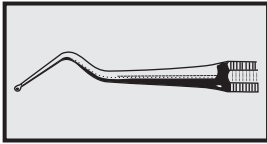

Probes & Explorers

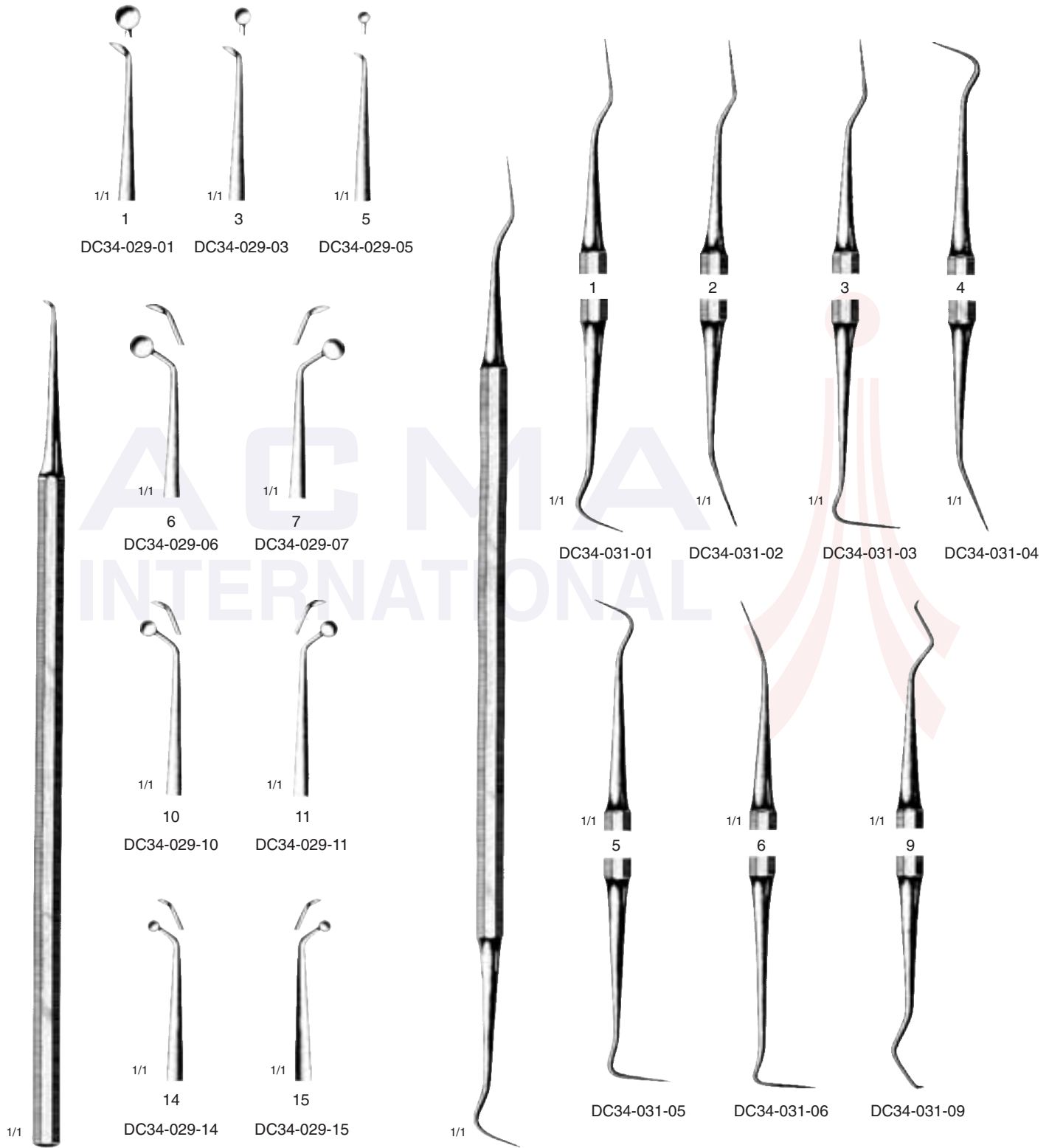

Witzel
Dentine Spoon

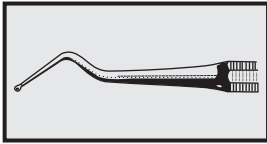

Excavators

1/1						
	5	6	7	8	9	10
A	DC34-033-05	DC34-033-06	DC34-033-07	DC34-033-08	DC34-033-09	DC34-033-10
	5/6		7/8		9/10	
E	DC34-035-05		DC34-035-07		DC34-035-09	





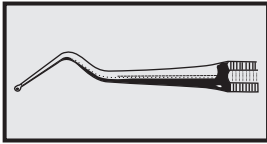

1/1						
	11	12	13	14	15	16
A	DC34-033-11	DC34-033-12	DC34-033-13	DC34-033-14	DC34-033-15	DC34-033-16
	11/12		13/14		15/16	
E	DC34-035-11		DC34-035-13		DC34-035-15	







1/1						
	17	18	19	20	21	22
A	DC34-033-17	DC34-033-18	DC34-033-19	DC34-033-20	DC34-033-21	DC34-033-22
	17/18		19/20		21/22	
E	DC34-035-17		DC34-035-19		DC34-035-21	







Darby-Perry



Excavators





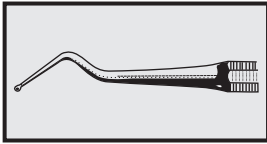

						
	1/1	1/1	1/1	1/1	1/1	1/1
	3	4	7	8	9	10
A	DC34-037-03	DC34-037-04	DC34-037-07	DC34-037-08	DC34-037-09	DC34-037-10
	3/4		7/8		9/8	
E	DC34-039-03		DC34-039-07		DC34-039-09	









						
	1/1	1/1	1/1	1/1	1/1	1/1
	11	12	13	14	15	16
A	DC34-037-11	DC34-037-12	DC34-037-13	DC34-037-14	DC34-037-15	DC34-037-16
	11/12		13/14		15/16	
E	DC34-039-11		DC34-039-13		DC34-039-15	









						
	1/1	1/1	1/1	1/1	1/1	1/1
	17	18	19	20	21	22
A	DC34-037-17	DC34-037-18	DC34-037-19	DC34-037-20	DC34-037-21	DC34-037-22
	17/18		19/20		21/22	
E	DC34-039-17		DC34-039-19		DC34-039-21	



Excavators

						
	1/1	1/1	1/1	1/1	1/1	1/1
	23	24	25	26	27	28
A	DC34-037-23	DC34-037-24	DC34-037-25	DC34-037-26	DC34-037-21	DC34-037-28
	23/24		25/26		27/28	
E	DC34-039-23		DC34-039-25		DC34-039-27	

								
	1/1	1/1	1/1	1/1	1/1	1/1	1/1	1/1
	29	30	31	32	33	34	35	36
A	DC34-037-29	DC34-037-30	DC34-037-31	DC34-037-32	DC34-037-33	DC34-037-34	DC34-037-35	DC34-037-36
	29/30		31/32		33/34		35/36	
E	DC34-039-29		DC34-039-31		DC34-039-33		DC34-039-35	

								
	1/1	1/1	1/1	1/1	1/1	1/1	1/1	1/1
	4	5	6	7	12	13	14	15
	Gillet	Gillet	Gillet	Gillet	Gillet	Gillet	Gillet	Gillet
A	DC34-041-04	DC34-041-05	DC34-041-06	DC34-041-07	DC34-041-12	DC34-041-13	DC34-041-14	DC34-041-15
	4/5		6/7		12/13		14/15	
E	DC34-043-04		DC34-043-06		DC34-043-12		DC34-043-14	

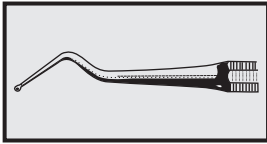

1/1

	171	172	173	174
A	DC34-045-71	DC34-045-72	DC34-045-73	DC34-045-74
	171/172		173/174	
E	DC34-047-71		DC34-047-73	

1/1

	175	176
A	DC34-045-75	DC34-045-76
	175/176	
E	DC34-047-75	

1/1

	177	178	179	180
A	DC34-045-77	DC34-045-78	DC34-045-79	DC34-045-80
	177/178		179/180	
E	DC34-047-77		DC34-047-79	

1/1

Friedman
DC34-049-01

1/1

Friedman
DC34-051-01

A E

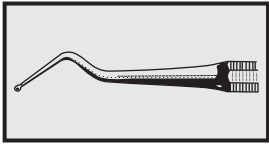

Excavators

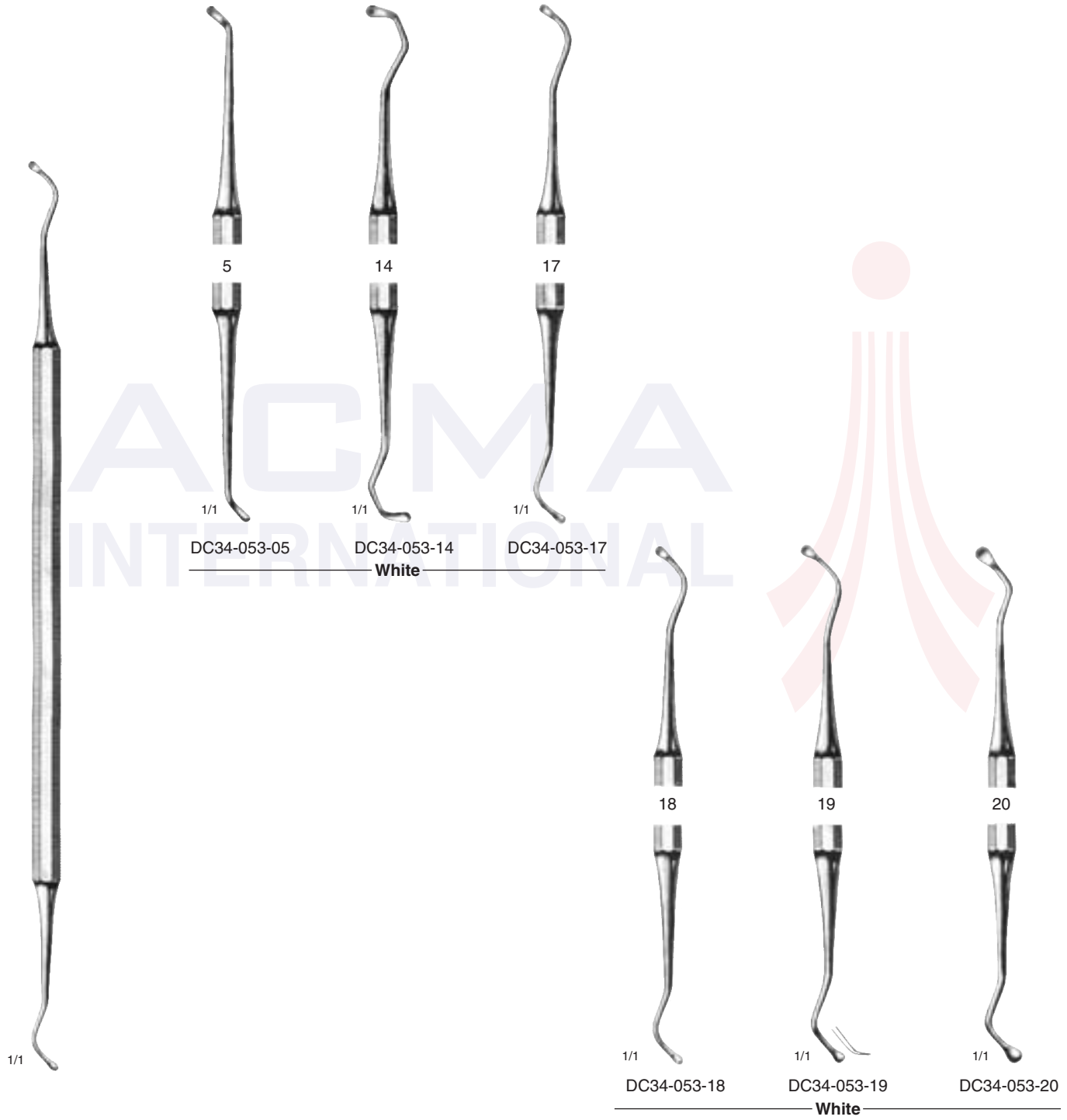

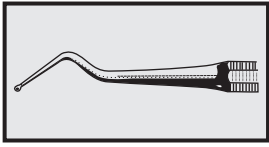

Excavators

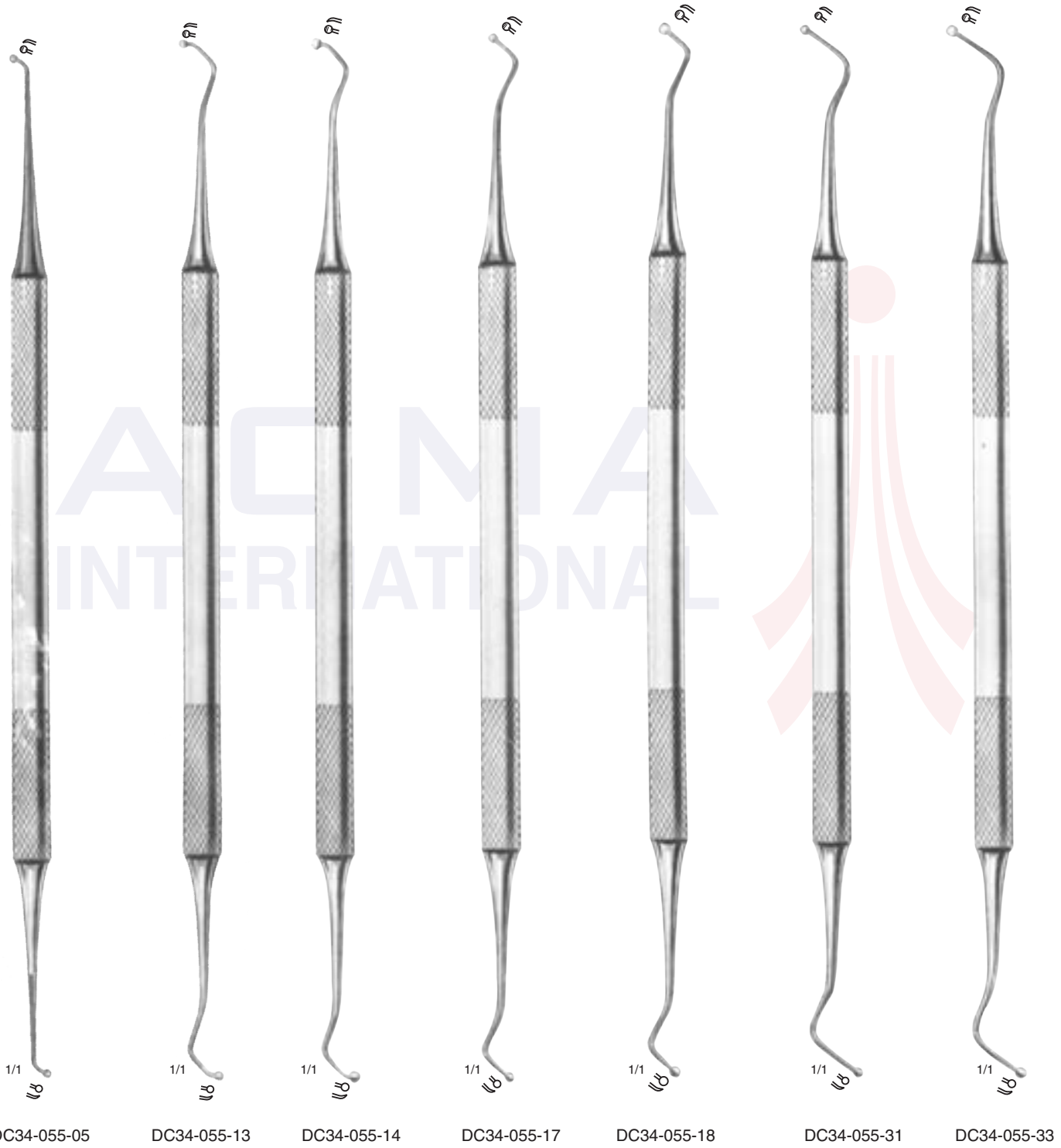

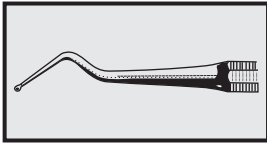

Cutting Instruments

1/1							
	3	9	14	17	20	28	32
	DC34-057-03	DC34-057-09	DC34-057-14	DC34-057-17	DC34-057-20	DC34-057-28	DC34-057-32
	A 10	10	12	6	12	8	12
	B 4	4	5	2	5	3	5
	C 6	12	18	18	23	6	12
	38	41	51	52	53	54	57
	DC34-057-38	DC34-057-41	DC34-057-51	DC34-057-52	DC34-057-53	DC34-057-54	DC34-057-57
A 12	6	15	15	10	10	15	
B 5	2	8	8	6	6	8	
C 18	18	12	12	12	12	6	
			L	R	L	R	L
1/1							
	58	61	62	63	64	65	66
	DC34-057-58	DC34-057-61	DC34-057-62	DC34-057-63	DC34-057-64	DC34-057-65	DC34-057-66
	15	20	20	15	15	10	10
	A 8	9	9	8	8	6	6
	B 6	12	12	12	12	12	12
	C R	L	R	L	R	L	R

A) Width of Blade in 1/10 mm
 B) Length of the blade in mm
 C) Angle of the blade to its handle

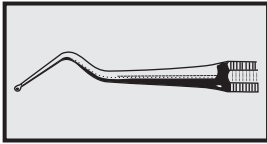

Cutting Instruments

 1/1							
	69	70	73	74	75	76	77
	DC34-059-69	DC34-059-70	DC34-059-73	DC34-059-74	DC34-059-75	DC34-059-76	DC34-059-77
	A 15	15	20	20	20	20	15
	B 8	8	9	9	9	9	8
	C 23	23	12	12	12	12	12
	L	R	L	R	L	R	L
	78	81	82	83	84	85	
	DC34-059-78	DC34-059-81	DC34-059-82	DC34-059-83	DC34-059-84	DC34-059-85	
A 15	20	15	10	20	15		
B 8	9	8	6				
C 12	6	6	6				
R							
	86	87	90	93	95	98	99
	DC34-059-86	DC34-059-87	DC34-059-90	DC34-059-93	DC34-059-95	DC34-059-98	DC34-059-99
	A 10	5	15	15	12	8	12
	B 3	3	1½	8	6	6	8
	C 28	12	12	12	23	12	

A) Width of Blade in 1/10 mm
 B) Length of the blade in mm
 C) Angle of the blade to its handle

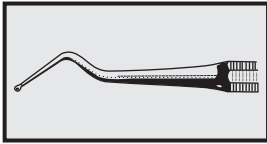

Cutting Instruments, double ended

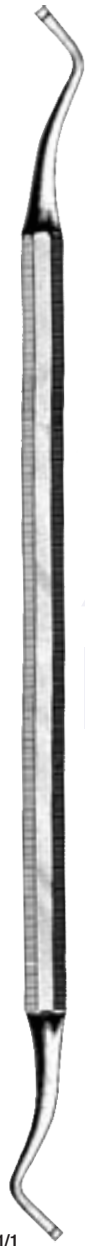

1/1

49	51	53	57	61	63
DC34-061-49	DC34-061-51	DC34-061-53	DC34-061-57	DC34-061-61	DC34-061-63
20	15	10	15	20	15
9	8	6	8	9	8
12	12	12	6	12	12
L	L	L	L	L	L

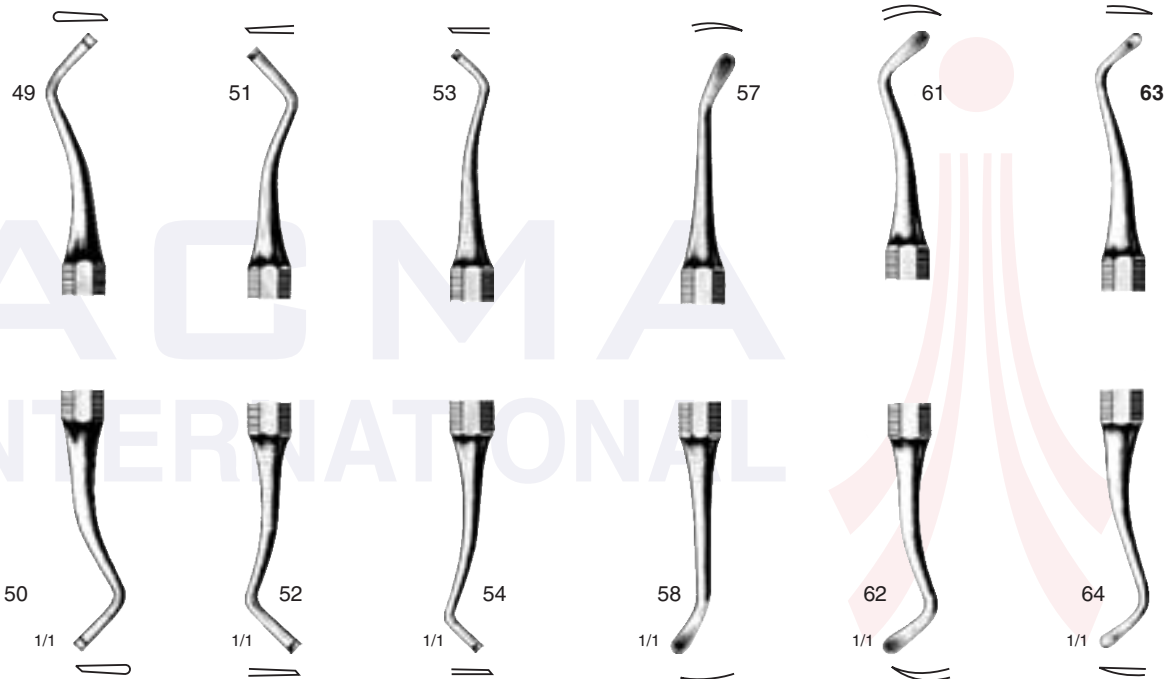

50	52	54	58	62	64
DC34-061-50	DC34-061-52	DC34-061-54	DC34-061-58	DC34-061-62	DC34-061-64
20	15	10	15	20	15
9	8	6	8	9	8
12	12	12	6	12	12
L	L	L	L	L	L

A) Width of Blade in 1/10 mm
 B) Length of the blade in mm
 C) Angle of the blade to its handle

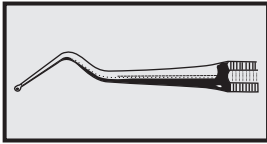

Cutting Instruments, double ended

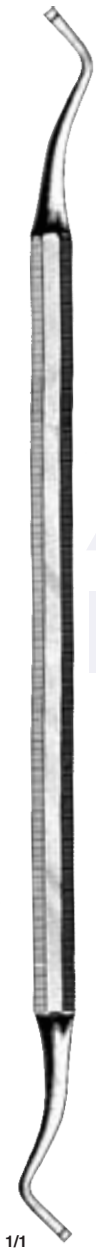

65	69	73	75	77	79
DC34-063-65	DC34-063-69	DC34-063-73	DC34-063-75	DC34-063-77	DC34-063-79
10	15	20	20	15	15
6	8	9	9	8	8
12	23	12	12	12	12
R	R	R	R	R	R

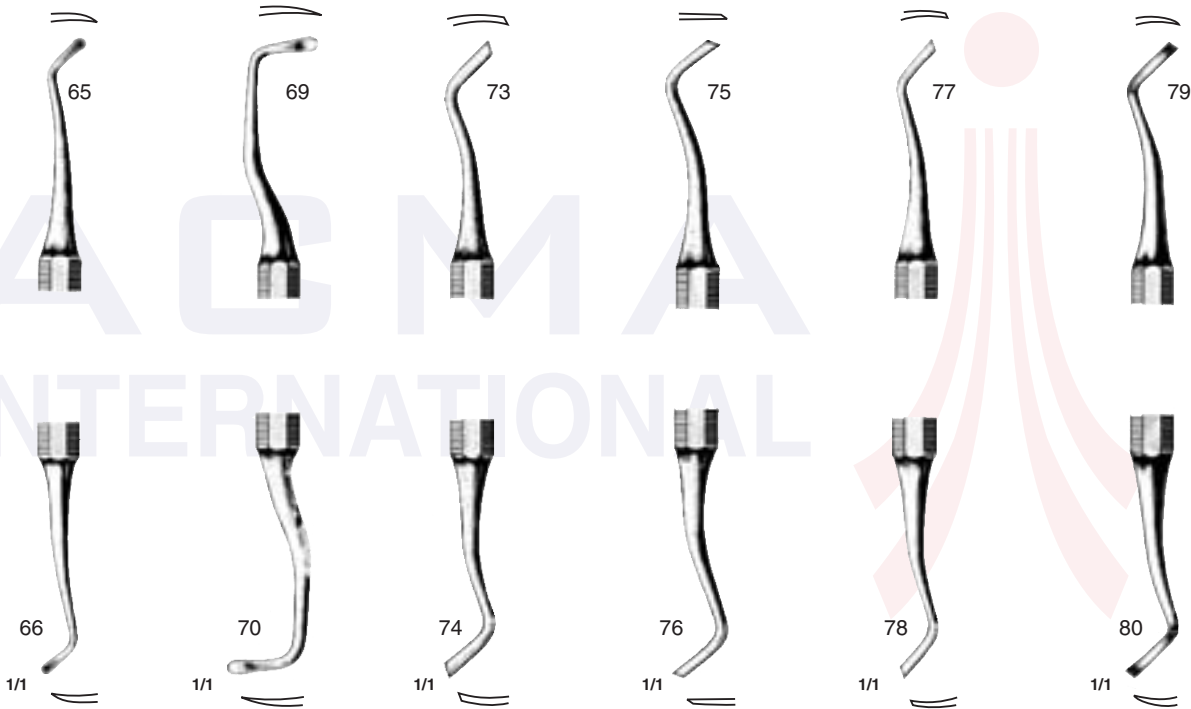

66	70	74	76	78	80
DC34-063-66	DC34-063-70	DC34-063-74	DC34-063-76	DC34-063-78	DC34-063-80
10	15	20	20	15	15
6	8	9	9	8	8
12	23	12	12	12	12
L	L	L	L	L	L

A) Width of Blade in 1/10 mm
 B) Length of the blade in mm
 C) Angle of the blade to its handle

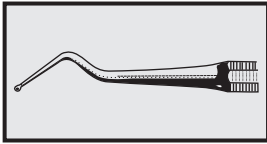

Cutting Instruments



DC34-065-34	DC34-065-43	Nerve Extractors, Spring tempered
DC34-067-01	DC34-067-03	Nerve and Root-Canal Pluggers
DC34-069-02	DC34-069-10	Nerve and Root-Canal Pluggers

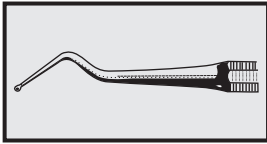

Nerve Instruments, Nerve Broach Holders



DC34-071-01	DC34-071-03	Nerve Canal Pluggers
DC34-073-01	DC34-073-03	Abscess and Fistula Probes

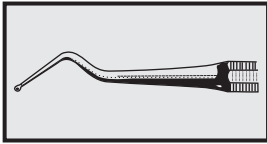

Gold Filling Instruments

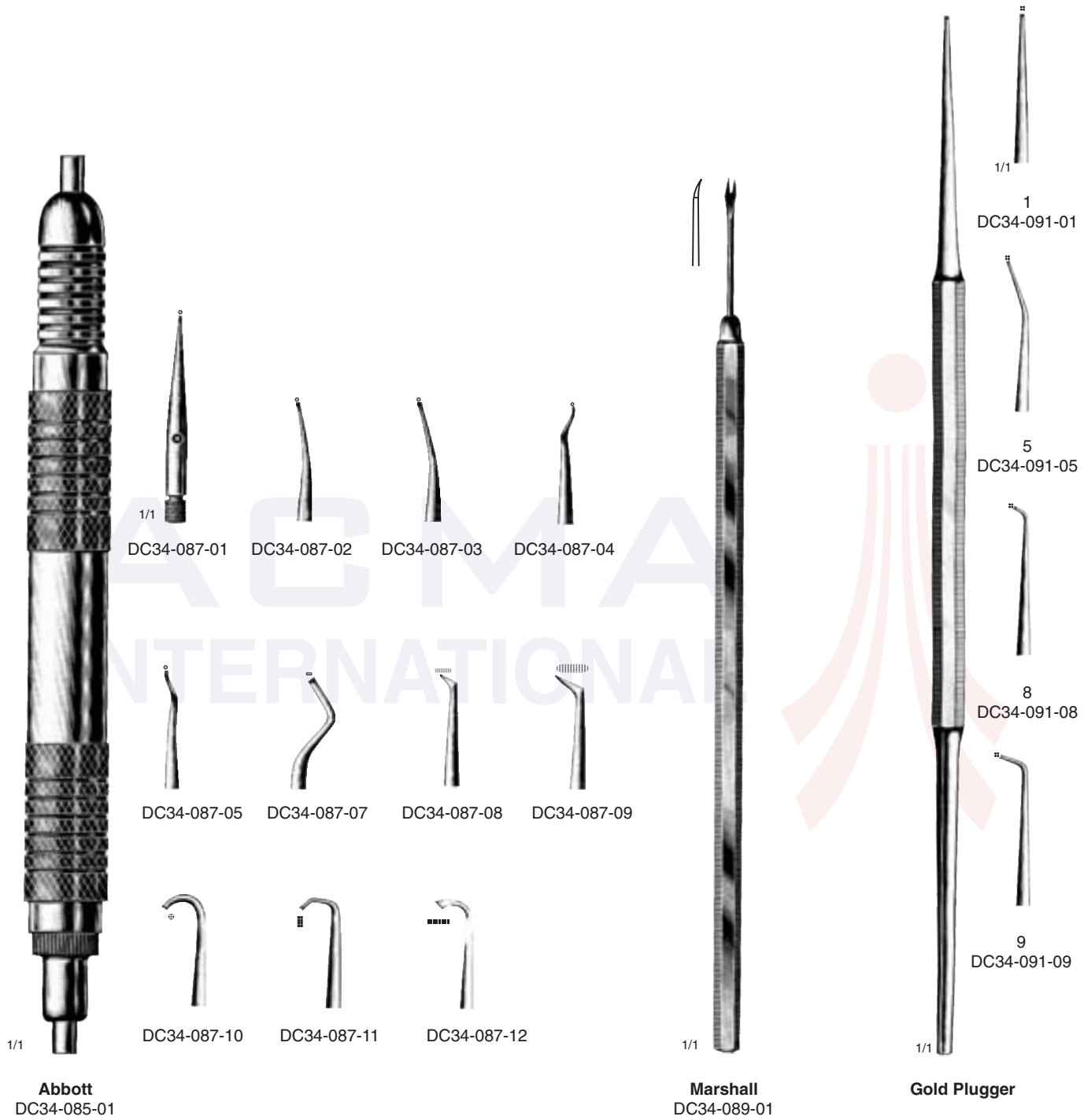

DC34-085-01	Automatic mallet
DC34-089-01	Pellet Placer
DC34-091-01	DC34-091-09
	Gold pluggers

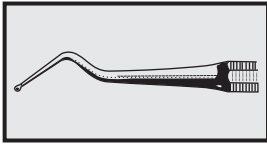

Finishing Instruments



1/1
Haubeil
DC34-009-01

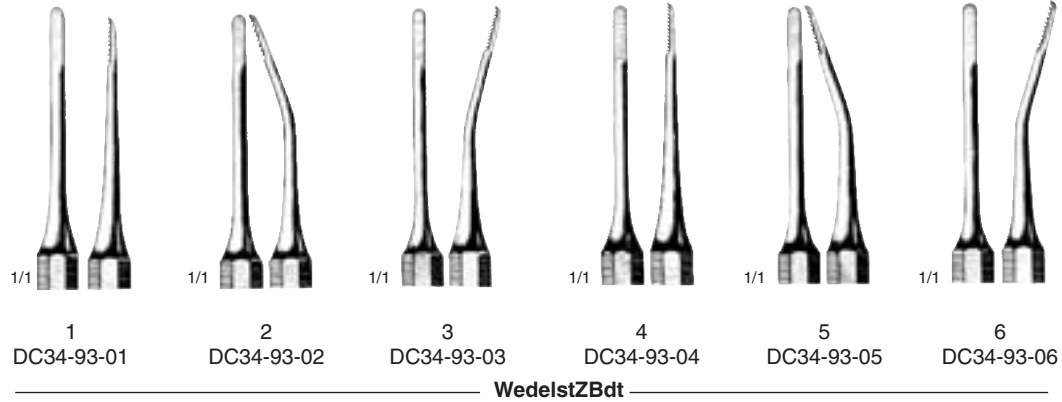

1 DC34-93-01 2 DC34-93-02 3 DC34-93-03 4 DC34-93-04 5 DC34-93-05 6 DC34-93-06
WedelstZBdt

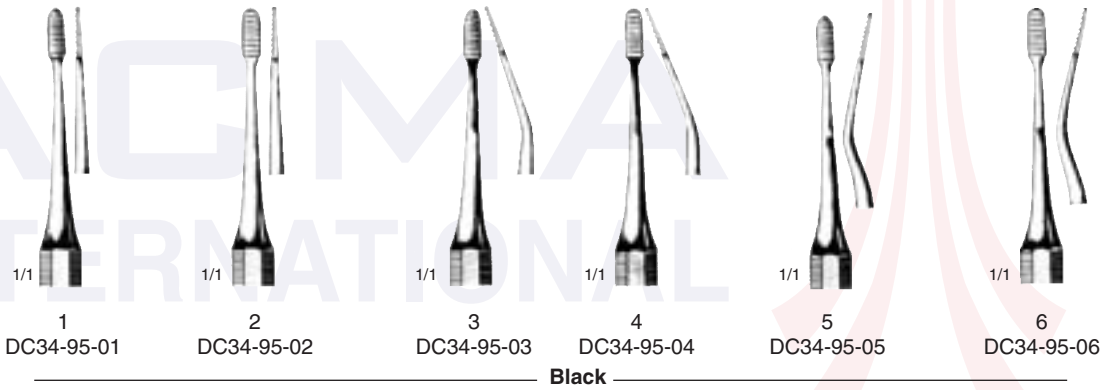

1 DC34-95-01 2 DC34-95-02 3 DC34-95-03 4 DC34-95-04 5 DC34-95-05 6 DC34-95-06
Black

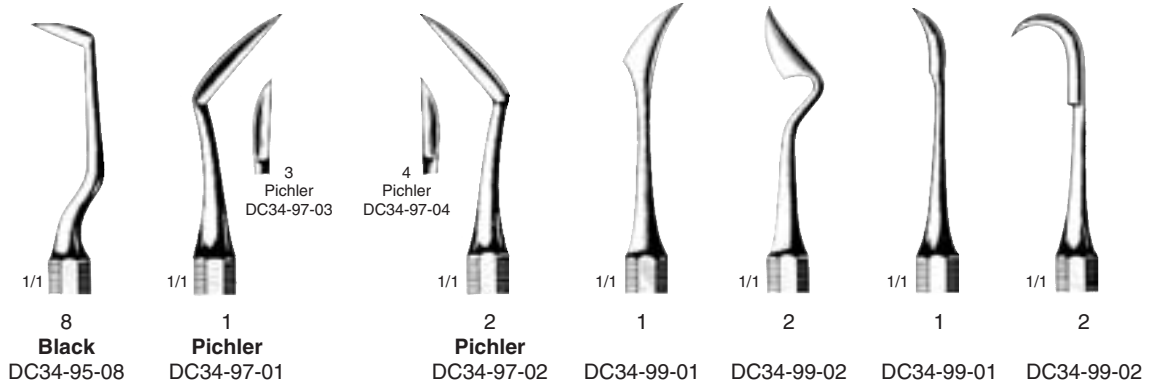

1/1 **Black** DC34-95-08 1/1 **Pichler** DC34-97-01 3/1 **Pichler** DC34-97-03 4/1 **Pichler** DC34-97-04 1/1 **Pichler** DC34-97-02 1/1 DC34-99-01 1/1 DC34-99-02 1/1 DC34-99-01 1/1 DC34-99-02

DC34-93-01	DC34-95-06	Finishing Files
DC34-95-08	DC34-99-02	Finishing Knives

Instruments for Amalgam,
Gutta-Percha and Cement

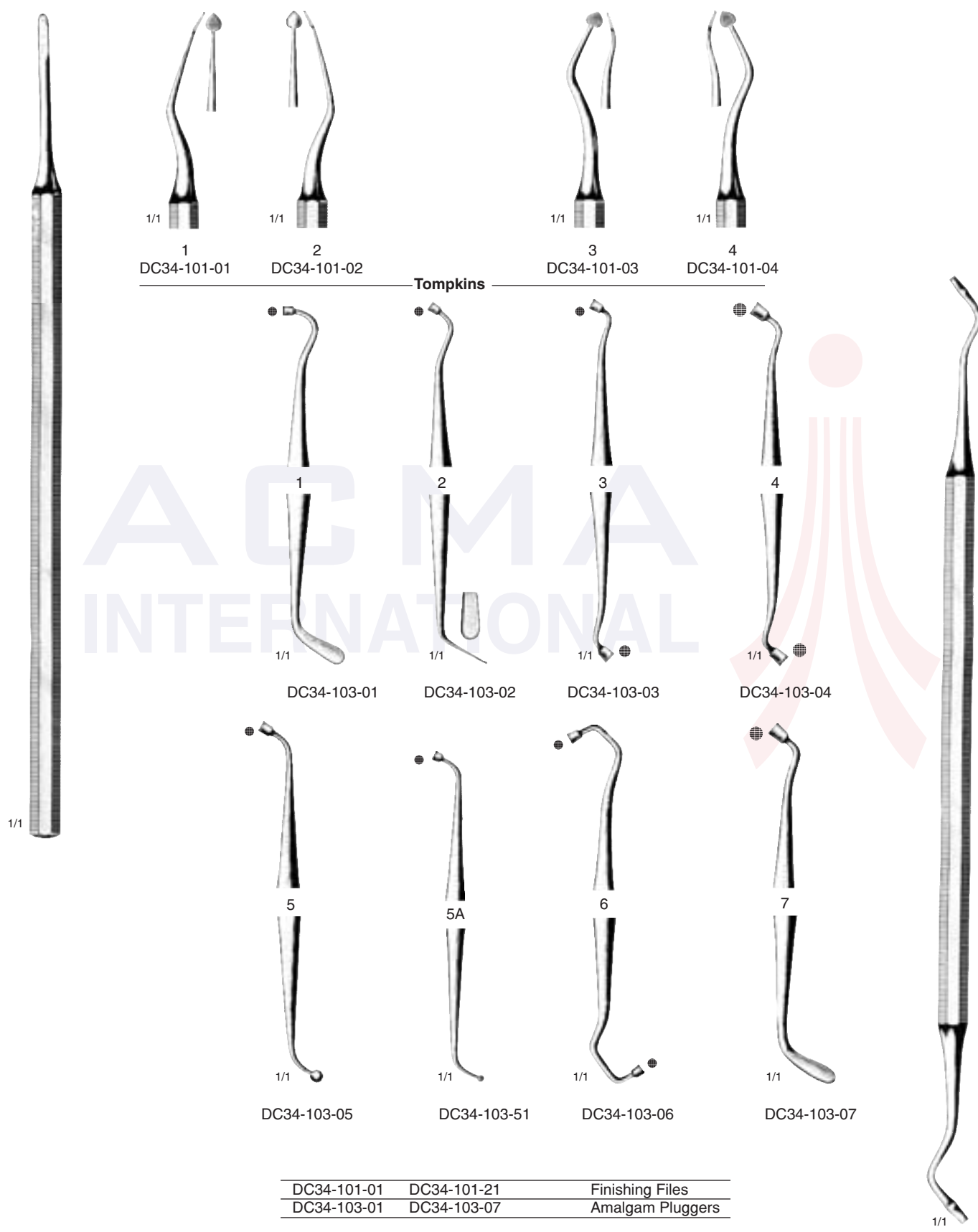
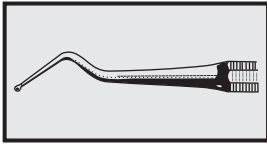

1/1
1 DC34-101-01
1/1
2 DC34-101-02
1/1
3 DC34-101-03
1/1
4 DC34-101-04

Tompkins

1/1
1 DC34-103-01
1/1
2 DC34-103-02
1/1
3 DC34-103-03
1/1
4 DC34-103-04

1/1
5 DC34-103-05
1/1
5A DC34-103-51
1/1
6 DC34-103-06
1/1
7 DC34-103-07

DC34-101-01	DC34-101-21	Finishing Files
DC34-103-01	DC34-103-07	Amalgam Pluggers

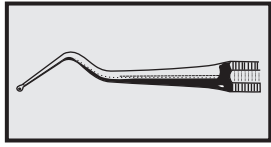

Instruments for Amalgam,
Gutta-Percha and Cement

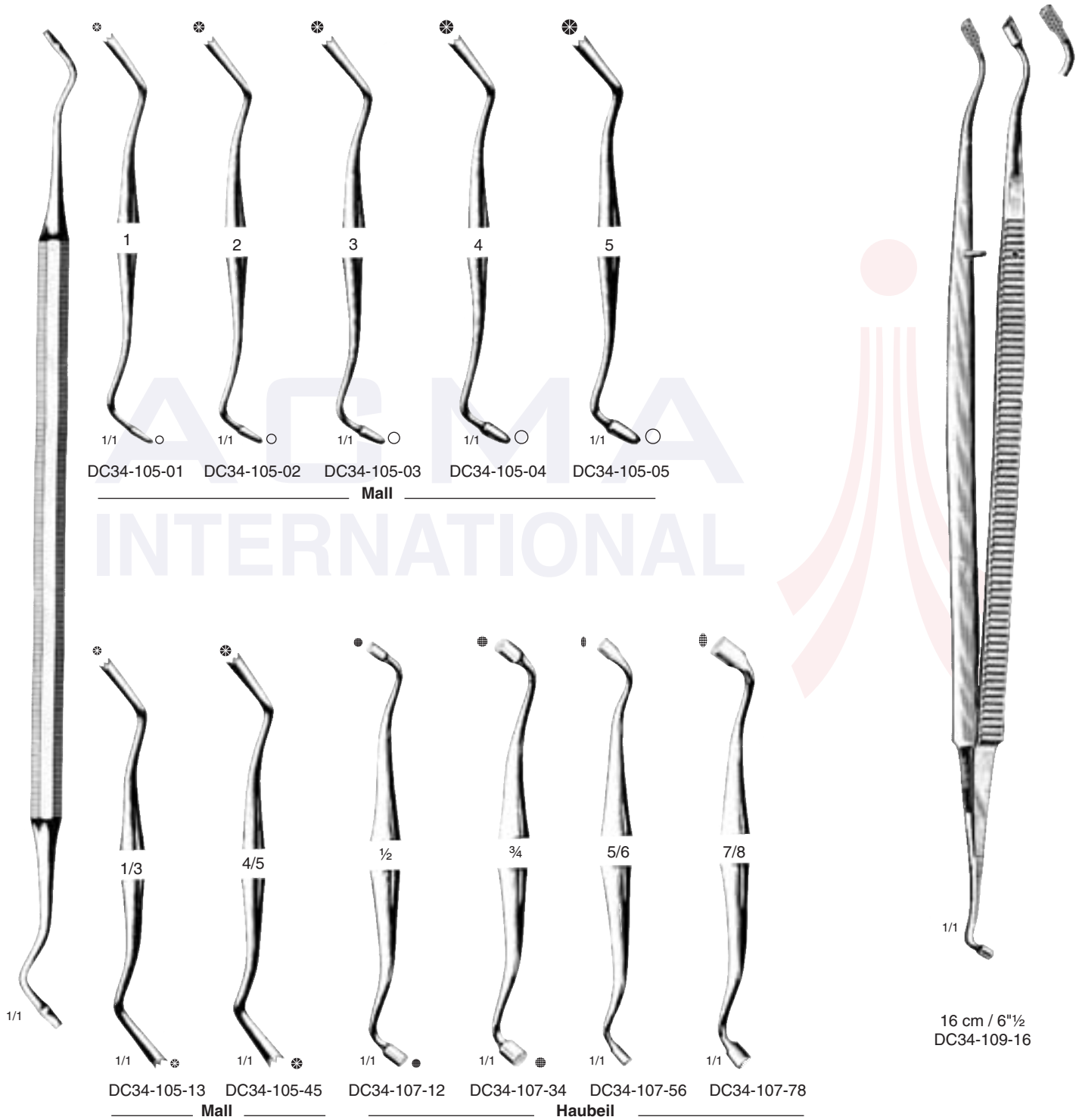

DC34-107-78	DC34-105-01	Amalgam Pluggers
	DC34-109-02	Amalgam Spetula
	DC34-111-16	Amalgam Plugging Pliers

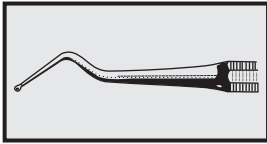

Instruments for Amalgam, Gutta-Percha and Cement



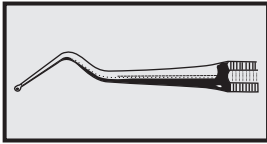

Instruments for Amalgam, Gutta-Percha and Cement

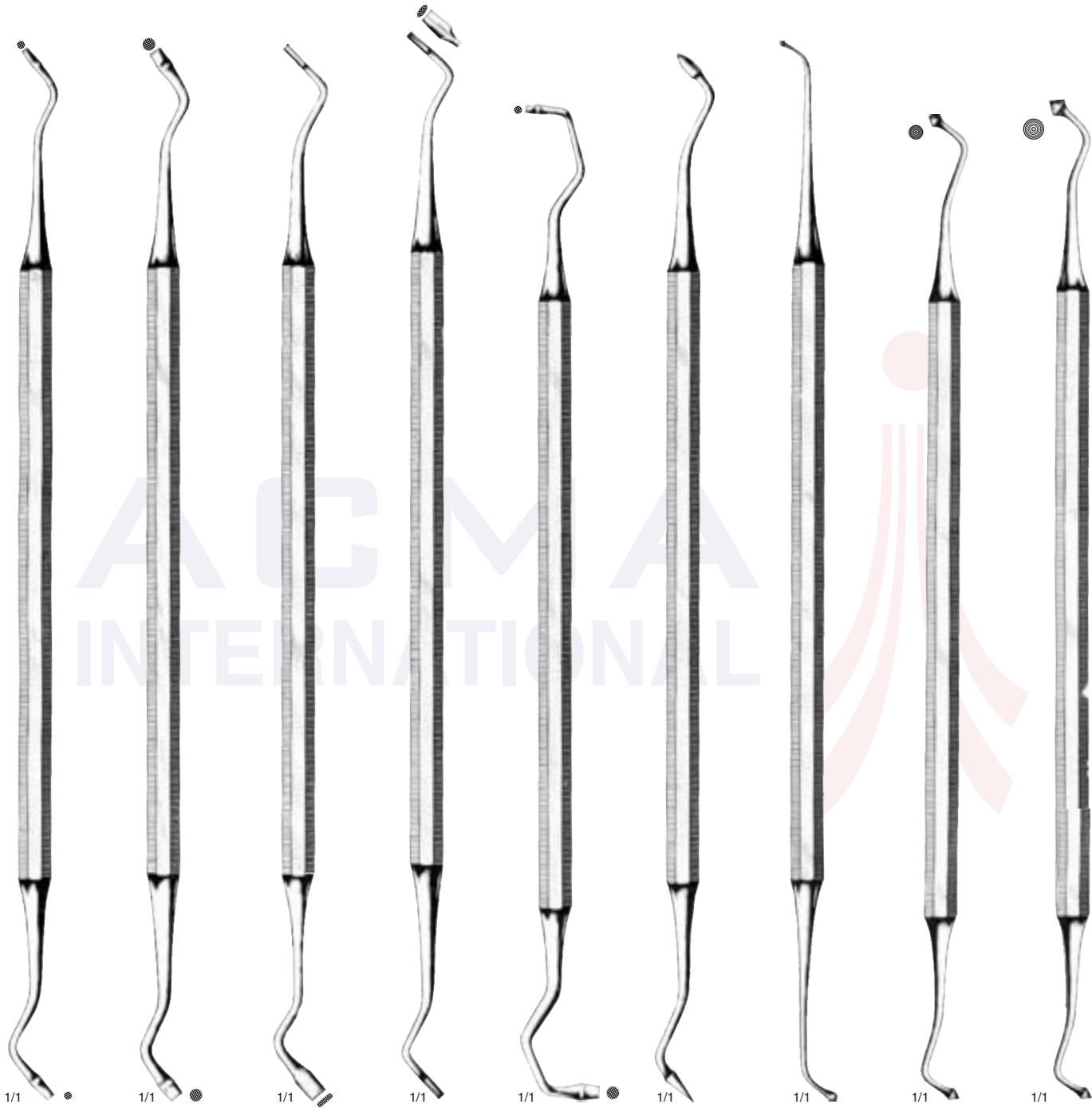

DC34-126-01 DC34-126-02 DC34-126-03 **Hollenback** DC34-126-04 DC34-126-05 DC34-126-06 DC34-126-07 **Mod. USA** DC34-127-01 **Mod. USA** DC34-127-02

DC34-126-01 DC34-127-02 Amalgam Condensers, Double-ended

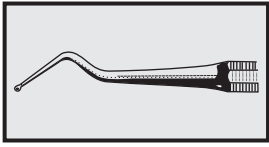

Amalgam Spoons



1/1
Pallas
DC34-128-01



1/1
DC34-129-01



1/1
Elliot
DC34-130-01

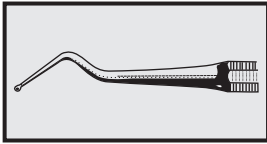

Amalgam Carriers



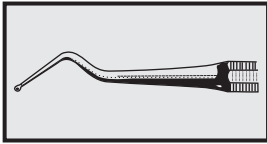

Amalgam Instruments



2/3

DC34-134-01
30 mm Ø



2/3

DC34-134-02
30 mm Ø



2/3

DC34-135-01



1/1

DC34-136-01



1/1

DC34-137-01

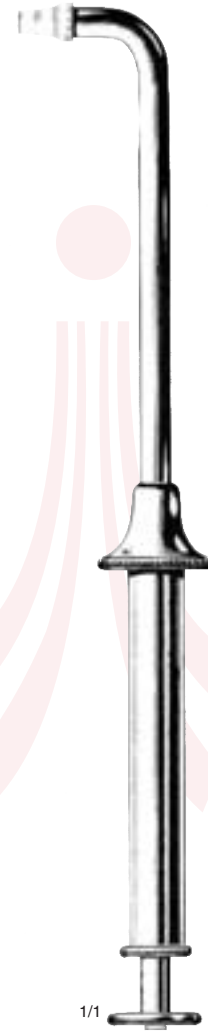

1/1

DC34-138-01

DC34-133-01	DC34-134-01	Finger Cups for pumice, amalgam, grinding paste
DC34-135-01		Mercury dispenser
DC34-136-01	DC34-138-01	Amalgam Guns

Instruments For Lifting
& Losing Temporary
Filling, Burnishers

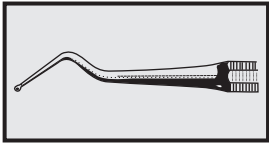

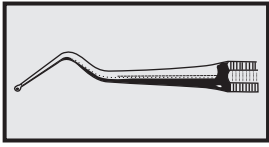

Plastic Filling Instruments

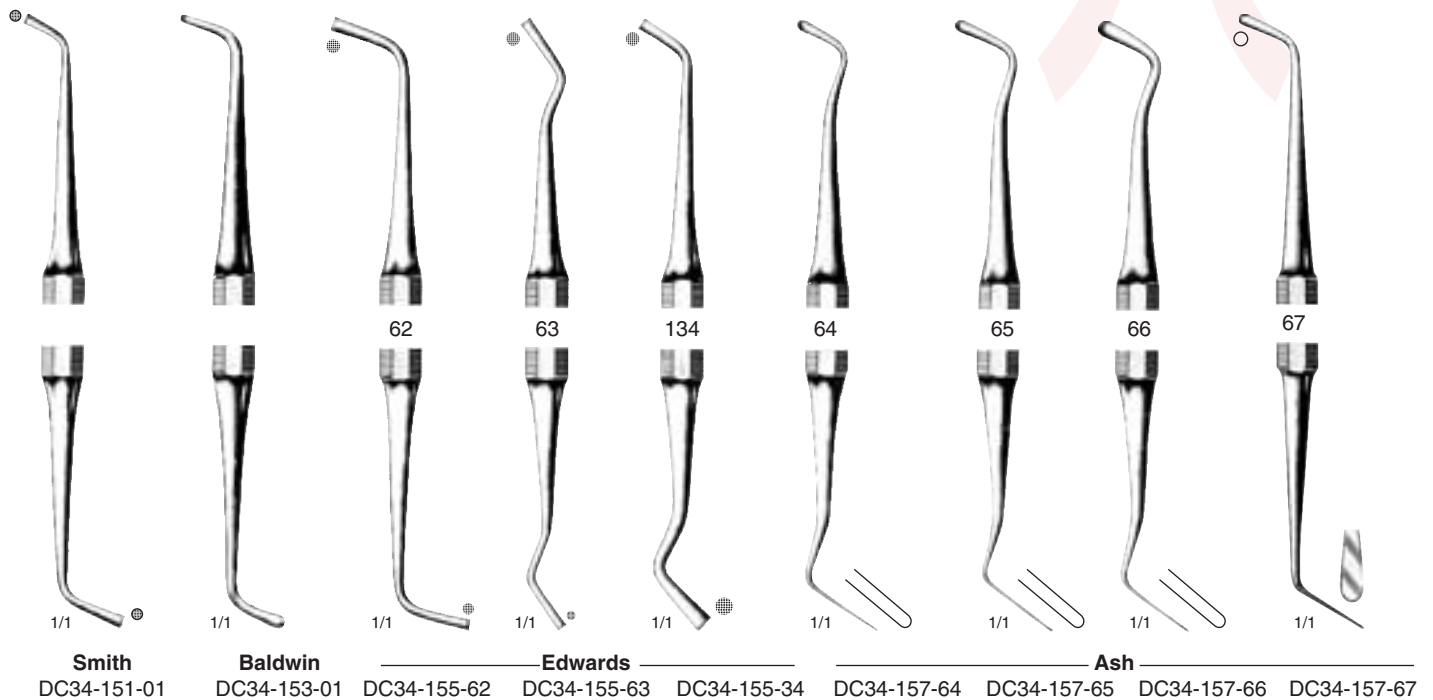

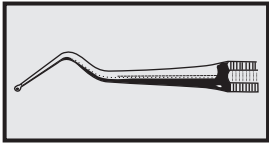

Plastic Filling Instruments



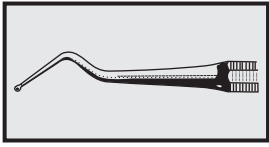

Plastic Filling Instruments

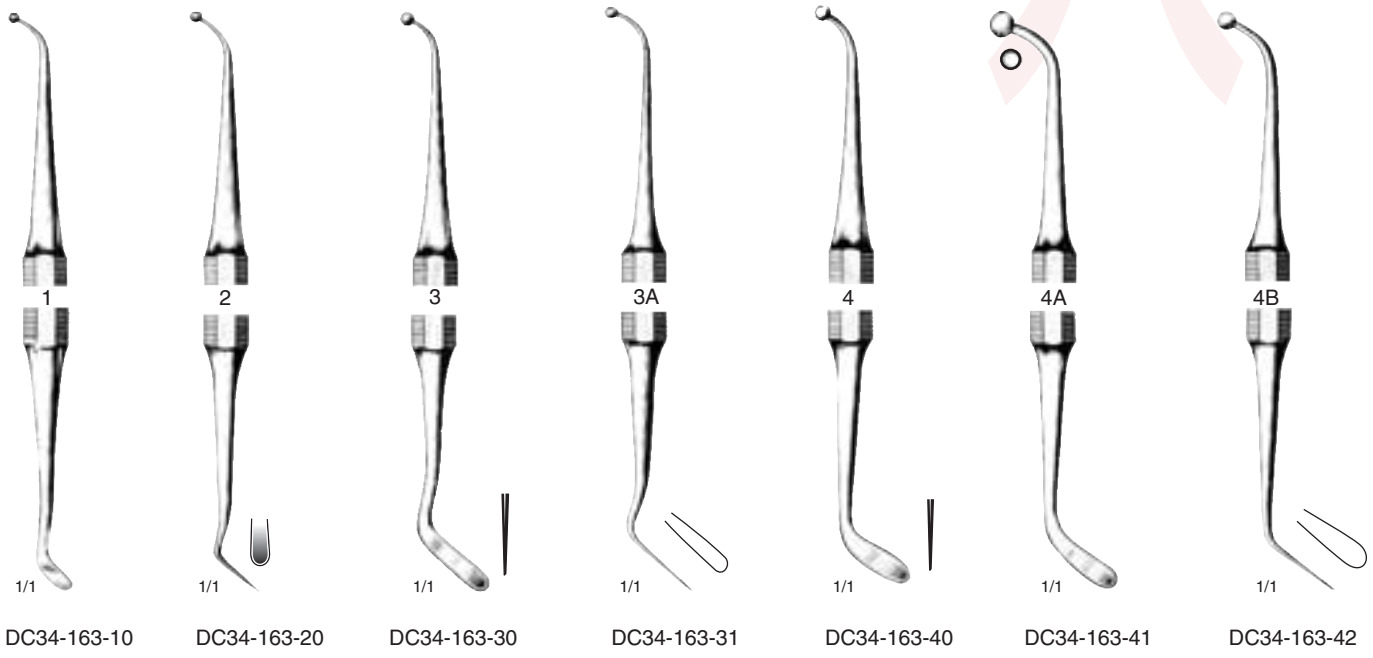
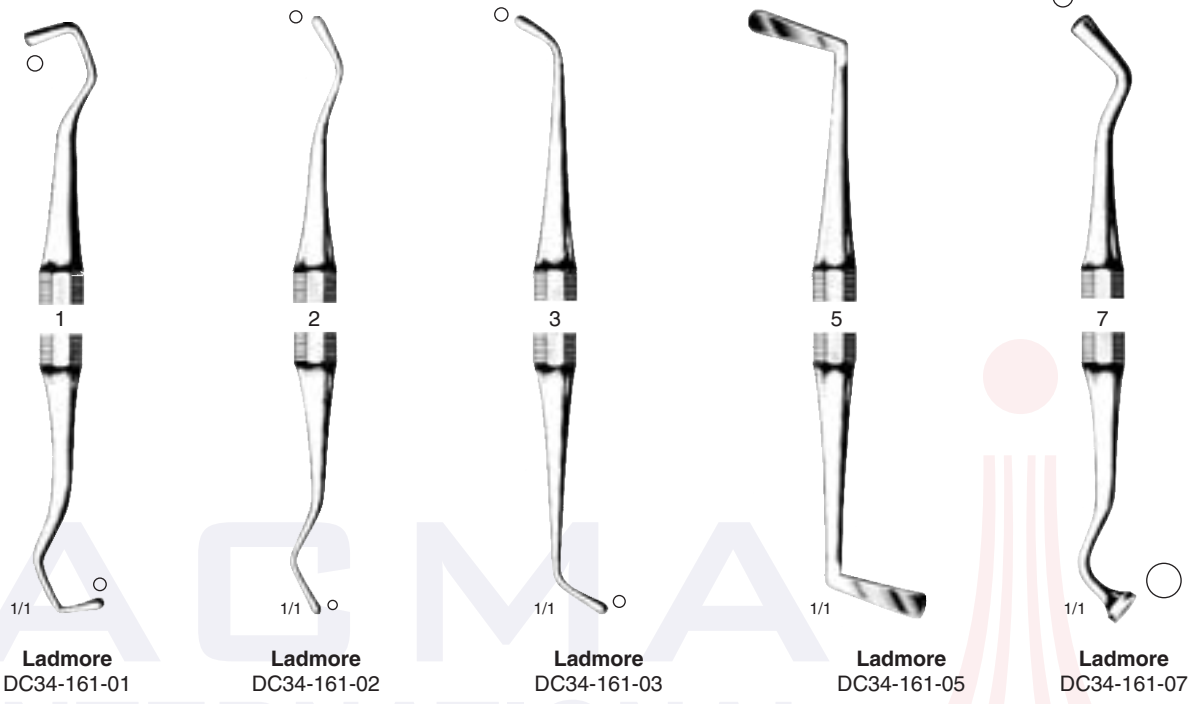

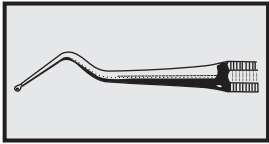

Plastic Filling Instruments



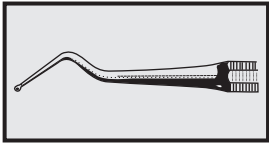

Plastic Filling Instruments

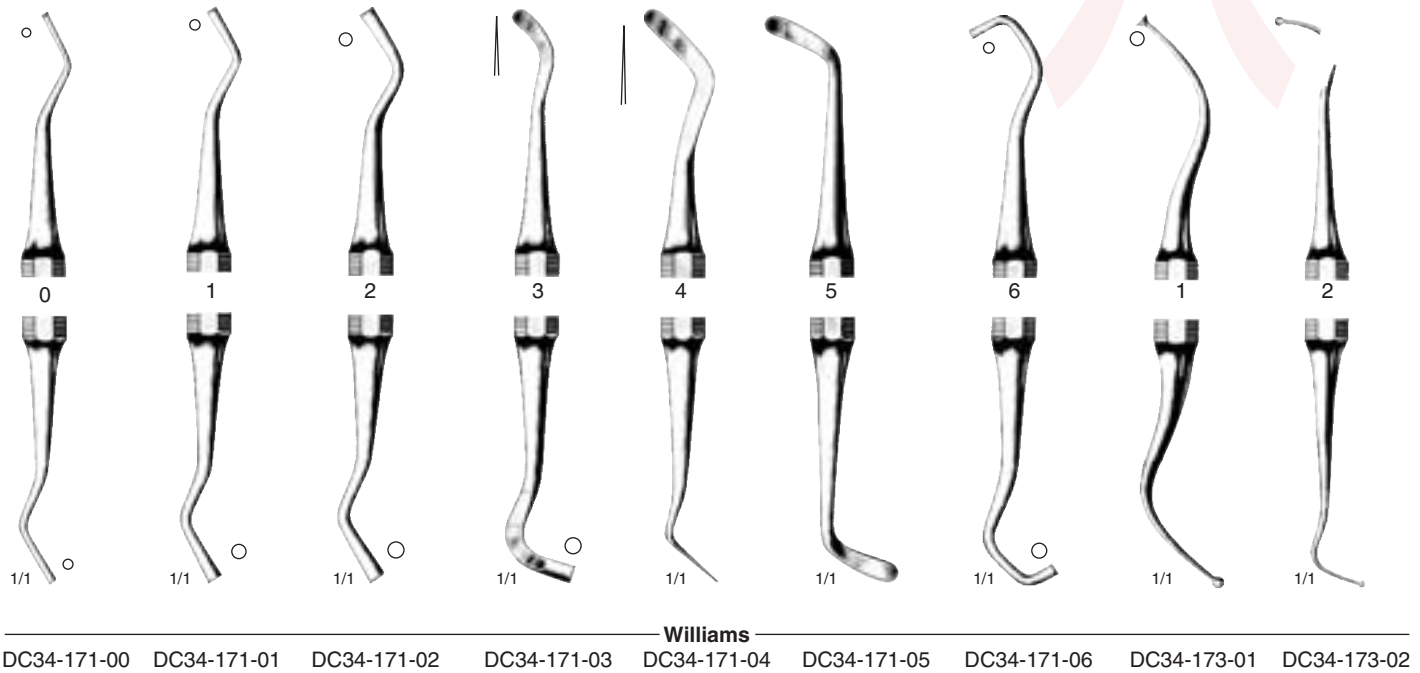
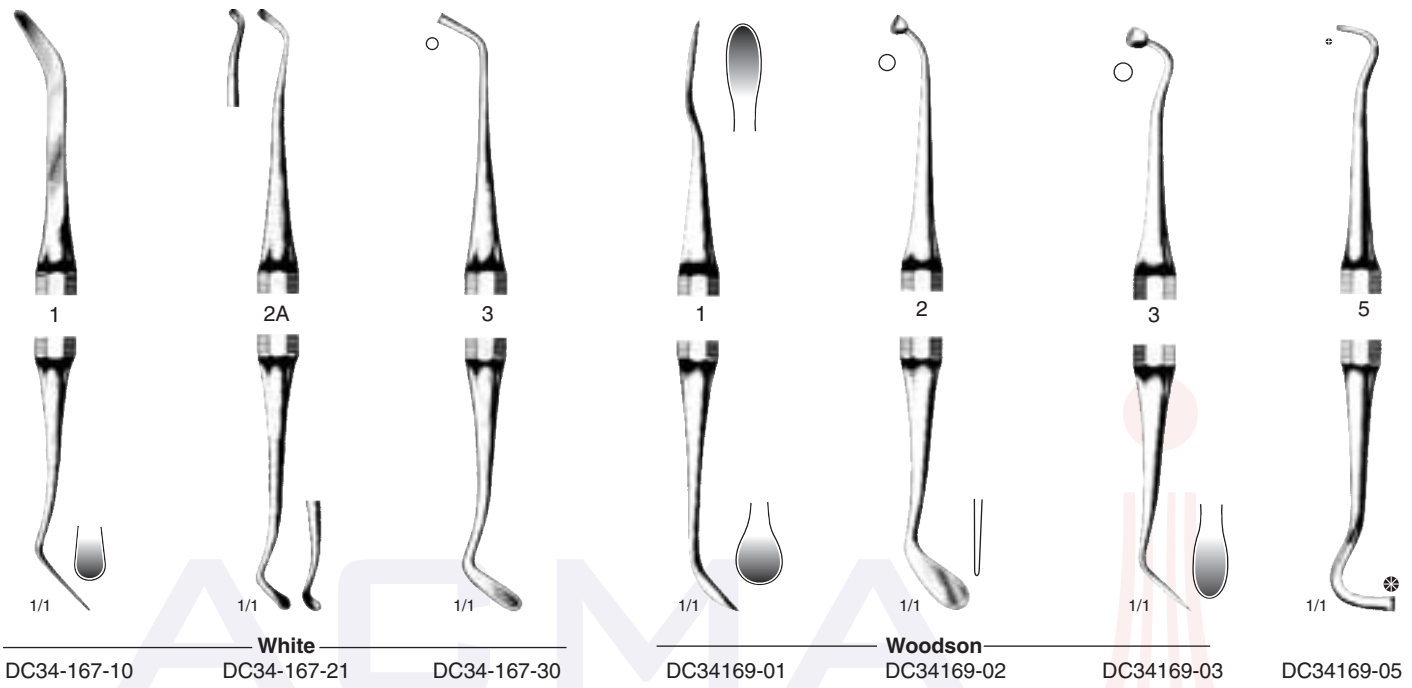

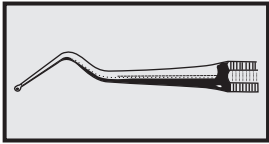

Plastic Filling Instruments

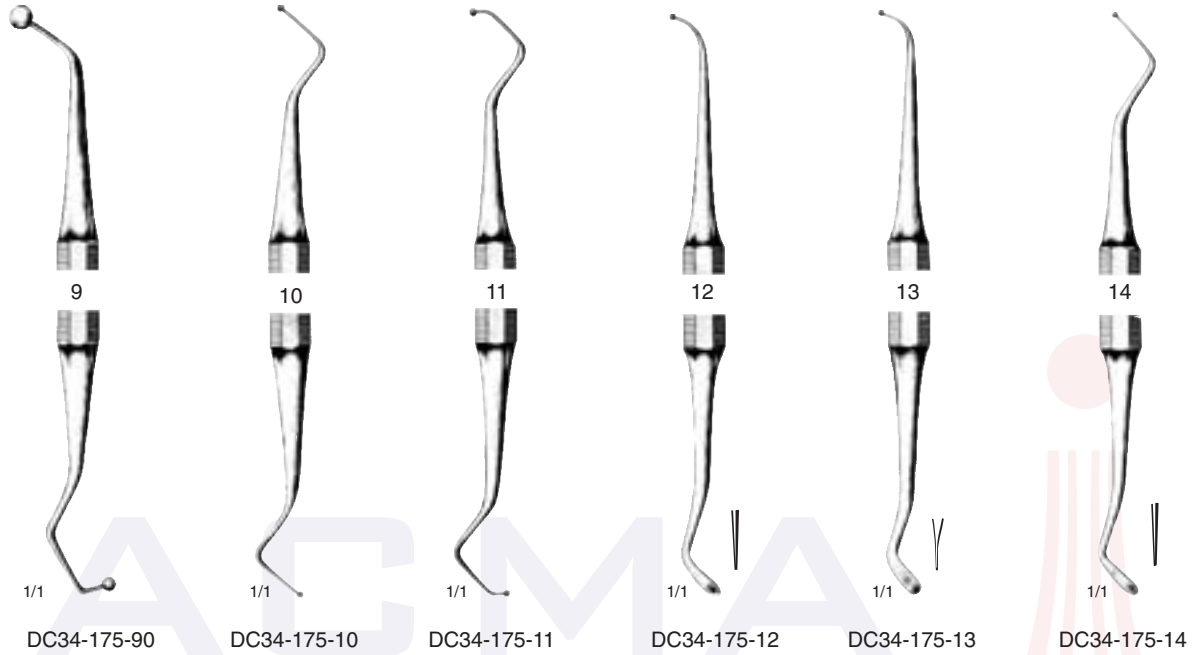

ACMA INTERNATIONAL

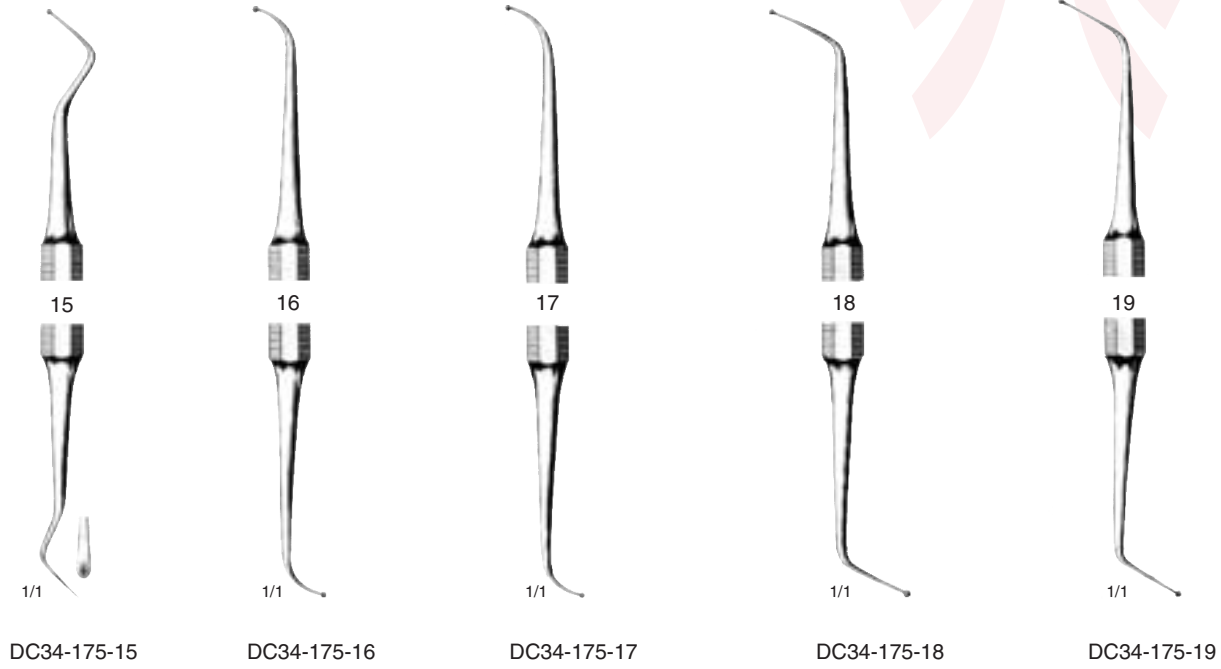

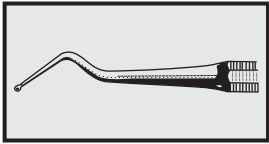

Plastic Filling Instruments

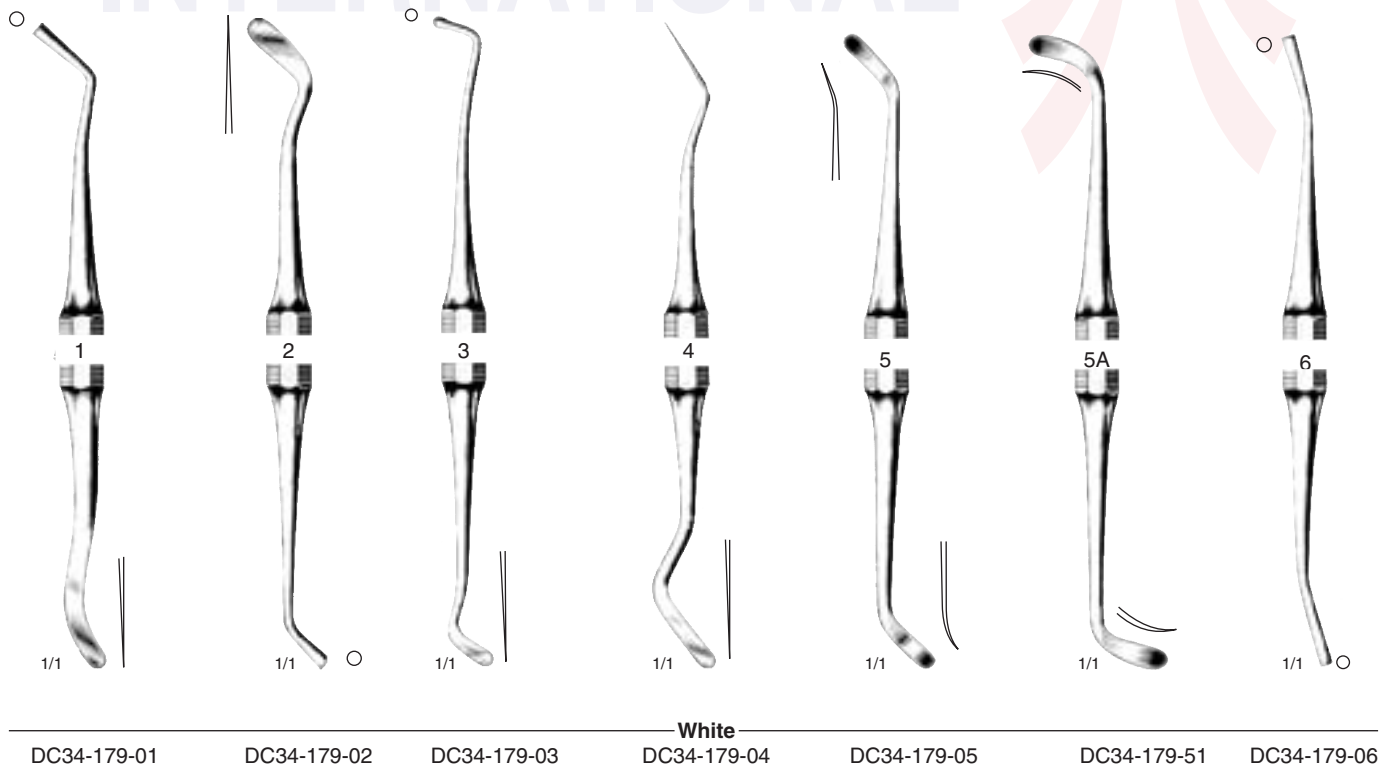
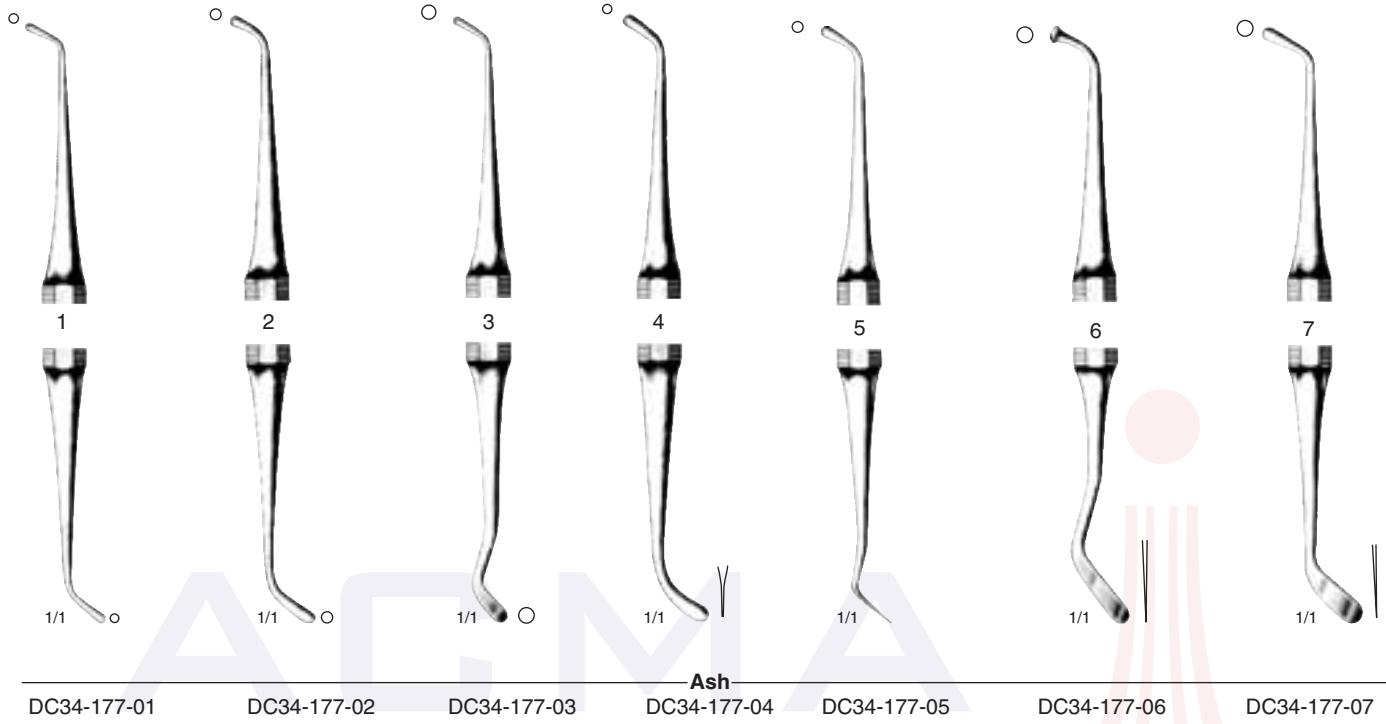

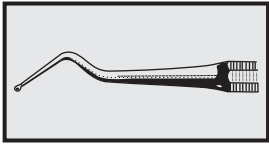

Filling Instruments



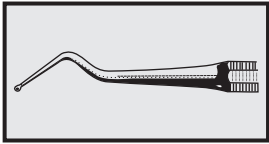

Filling Instruments



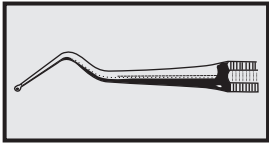

Amalgam & Filling Instruments

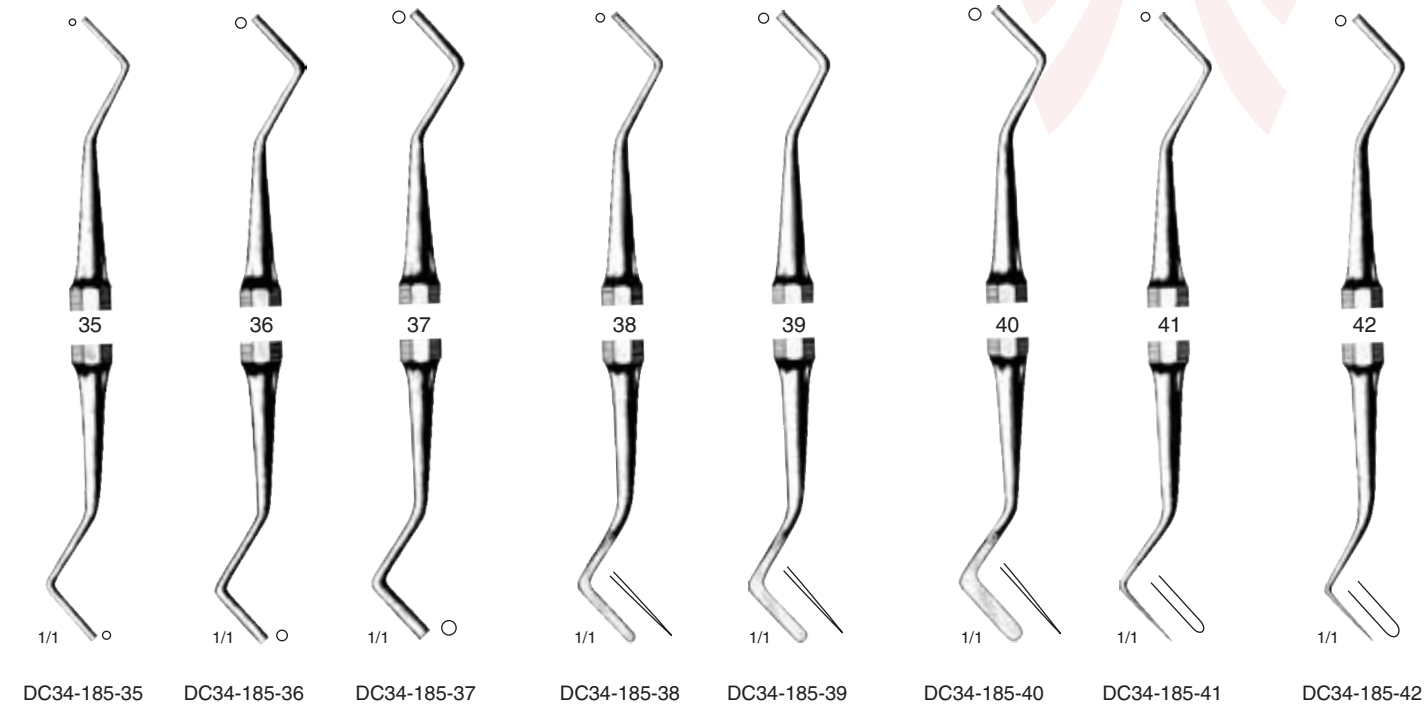
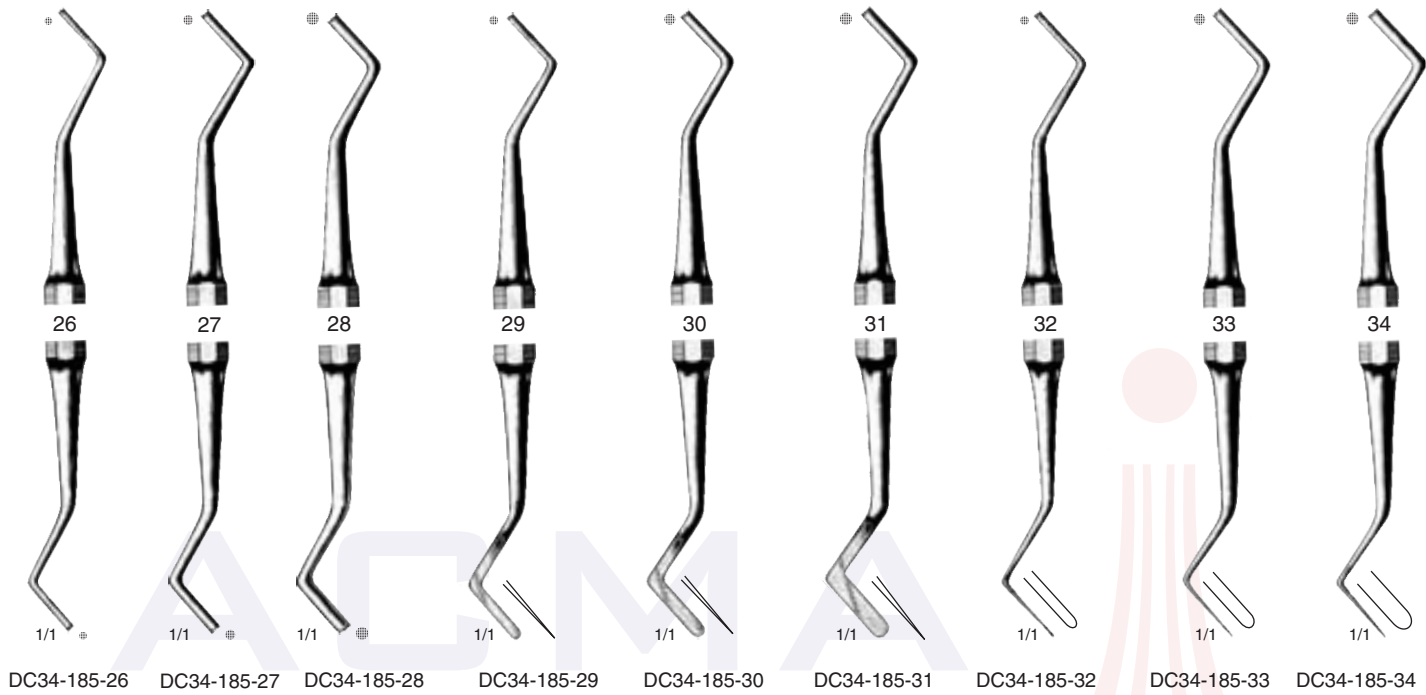

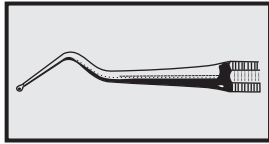

Contra Angle Instruments



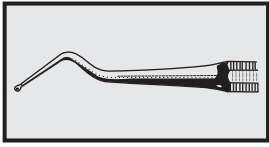

Plastic Filling Instruments



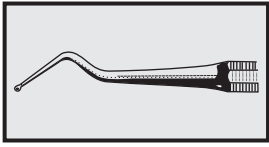

Cement Spatula, Silicate Spatula



DC34-219-01 DC34-221-05 Cement Spatula

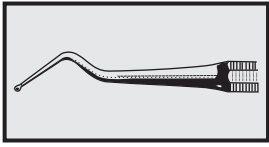

Cement Spatula



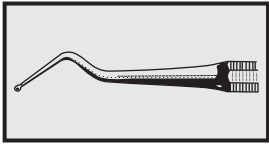

Gutta-Percha and Cement Speculas



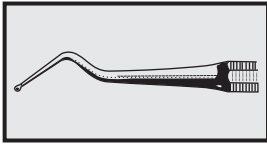

Fine Spatulas, Laboratory Spatulas
Spatulas For Plaster & Alginates



150 X 3 mm Ø
DC34-172-03



130 X 2 mm Ø DC34-237-02
185 x 2 mm Ø DC34-239-02
210 x 2 mm Ø DC34-241-02



DC34-243-02
DC34-245-02
DC34-247-02



100 X 2 mm Ø DC34-249-02
130 x 2 mm Ø DC34-251-02
150 x 2 mm Ø DC34-253-02



DC34-255-02
DC34-257-02
DC34-259-02



ACMA
INTERNATIONAL



150 X 3 mm Ø DC34-261-03
185 x 3 mm Ø DC34-263-03
210 x 3 mm Ø DC34-265-03



130 X 4 mm Ø DC34-267-04
155 x 4 mm Ø DC34-269-04



17.5 cm / 7"
DC34-207-17

19 cm / 7½" DC34-271-19
22 cm / 8¼" DC34-273-22
25 cm / 10" DC34-275-25
28 cm / 11" DC34-277-28
30 cm / 12" DC34-279-30
35 cm / 14" DC34-281-35



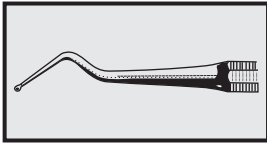

Matrix Retainer



1/1

Didner
DC34-283-01



1/1

Ivory
DC34-285-01



1/1

Ivory
DC34-287-01



1/1

Ivory
DC34-289-01



DC34-291-20 = 20 mm Ø
DC34-291-25 = 25 mm Ø
DC34-291-30 = 30 mm Ø



1/1

Ivory
DC34-293-01



1/1

Ivory
DC34-295-01



1/1

Ivory
DC34-297-01

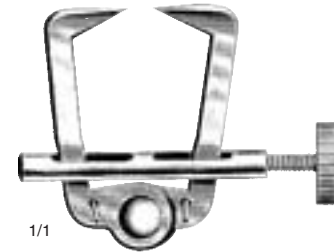

1/1

Elliot
DC34-299-01

DC34-283-01	DC34-289-01	Matrix Retainer
DC34-291-20	DC34-291-30	Rubber-dam Holder
DC34-293-01	DC34-295-01	Matrix Retainer
DC34-297-01	DC34-299-01	Separators

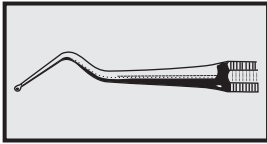

Matrix Pliers, Rubber-Dam Punch
& Clamp Forceps

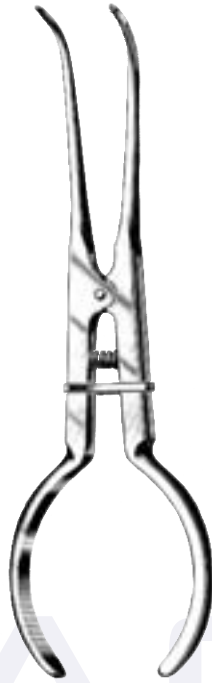

17 cm / 6¾"

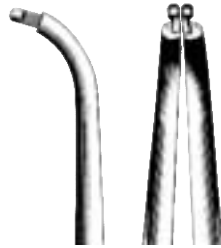

DC34-301-17



DC34-303-17

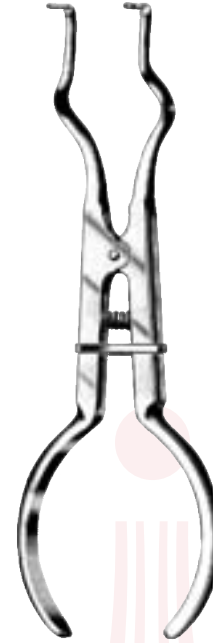

Brewer
17 cm / 6¾"
DC34-305-17



Ivory
17 cm / 6¾"
DC34-307-17

ACMA
INTERNATIONAL

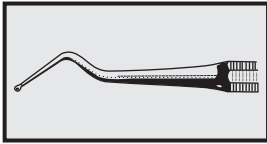

Rubber Dam Clamps



DC34-309-01



DC34-309-02

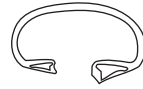

DC34-309-03

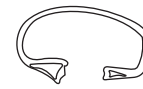

DC34-309-04



DC34-309-05



DC34-309-06

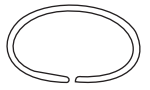

DC34-309-07



DC34-309-08

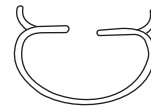

DC34-311-01

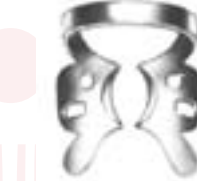

DC34-311-02

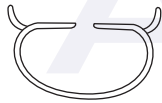

DC34-311-03

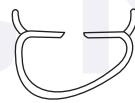

DC34-311-04



DC34-311-05



DC34-311-06



DC34-311-07



DC34-311-08



DC34-311-09

DC34-309-01	DC34-309-05	Molar Clamps
DC34-309-06	DC34-309-08	Bicuspid Clamps
DC34-311-01	DC34-311-06	Molar Clamps
DC34-311-07	DC34-311-09	Labial Clamps

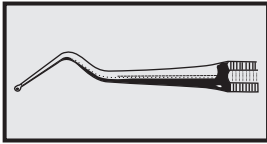

Rubber Dam Clamps



DC34-313-10



DC34-313-11



DC34-313-12



DC34-313-13



DC34-313-14



DC34-313-15



DC34-313-16



DC34-313-17



DC34-313-18



DC34-313-19



DC34-313-20



DC34-313-21



DC34-313-22



DC34-313-23



DC34-313-24



DC34-313-25



DC34-313-26



DC34-313-27

DC34-313-10	DC34-313-14	Molar Clamps
DC34-313-15	DC34-313-20	Molar Clamps
DC34-313-21	DC34-313-27	Bicuspid Clamps

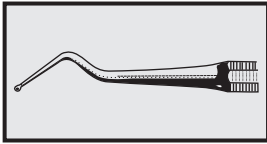

Matrix Band and Matrix Retainer

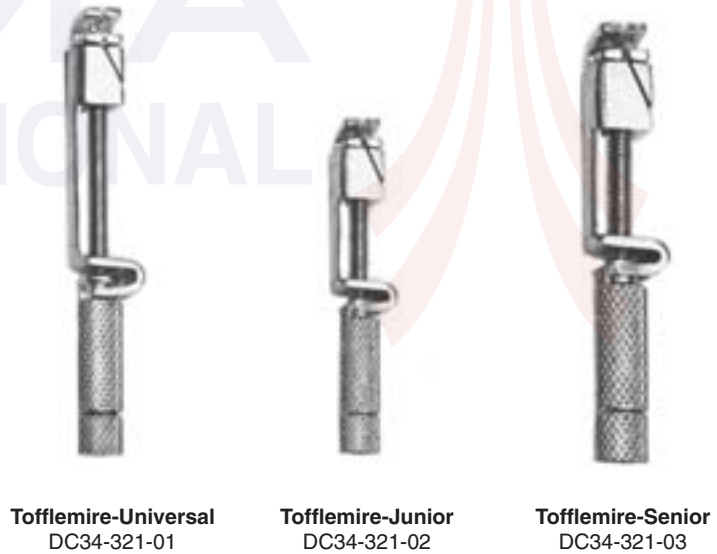
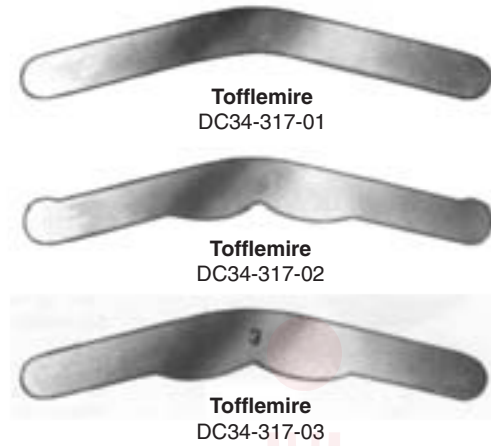
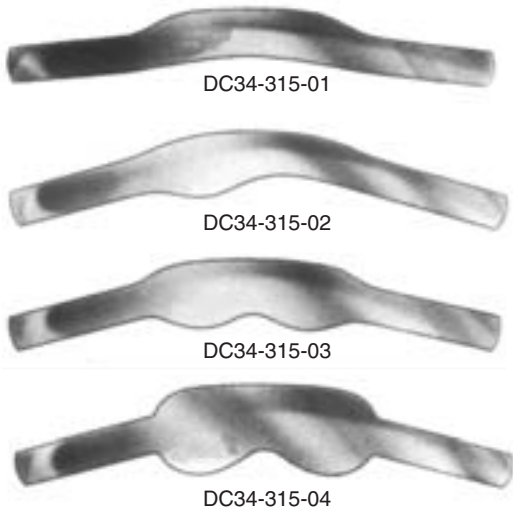

DC34-315-01	DC34-319-03	Matrix Bands
DC34-321-01	DC34-321-03	Matrix Retainer

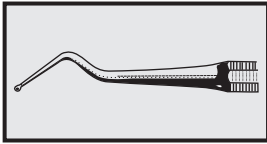

Scalers for Periodontosis and Pyorrhea

Periodontosis Instruments

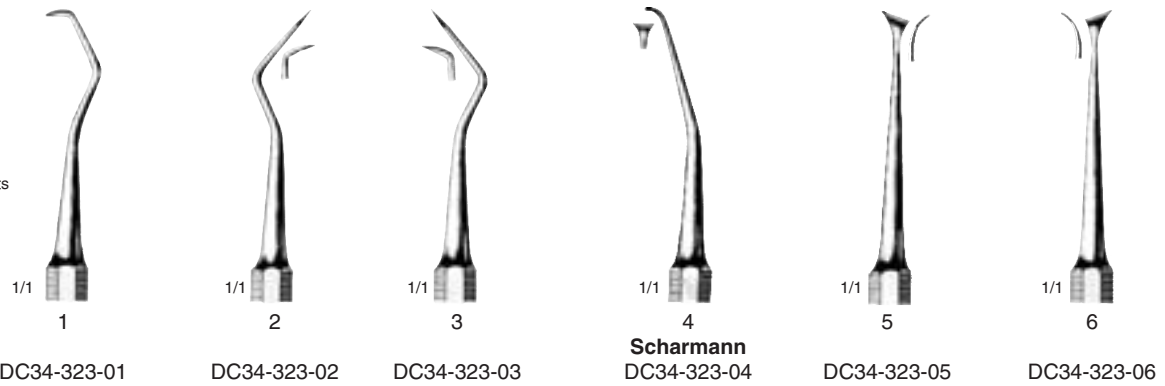

Periodontosis Instruments



Periodontosis Instruments



Files for Prophylaxis

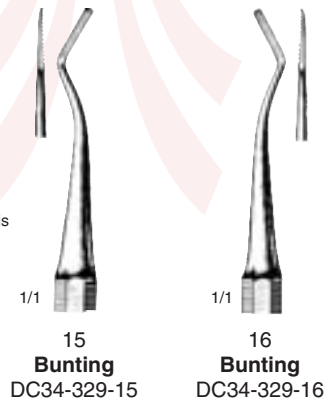

Files for Prophylaxis

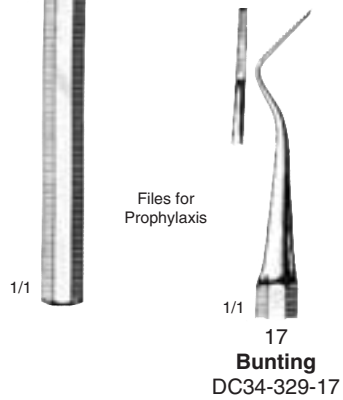

Pyorrhea Instruments

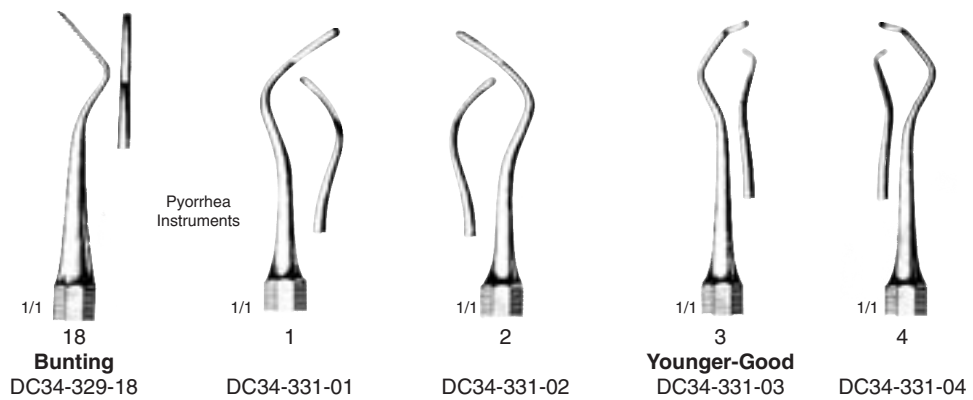

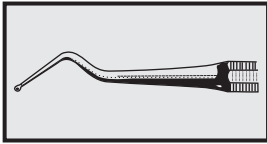

Scalers for Periodontosis and Pyorrhea

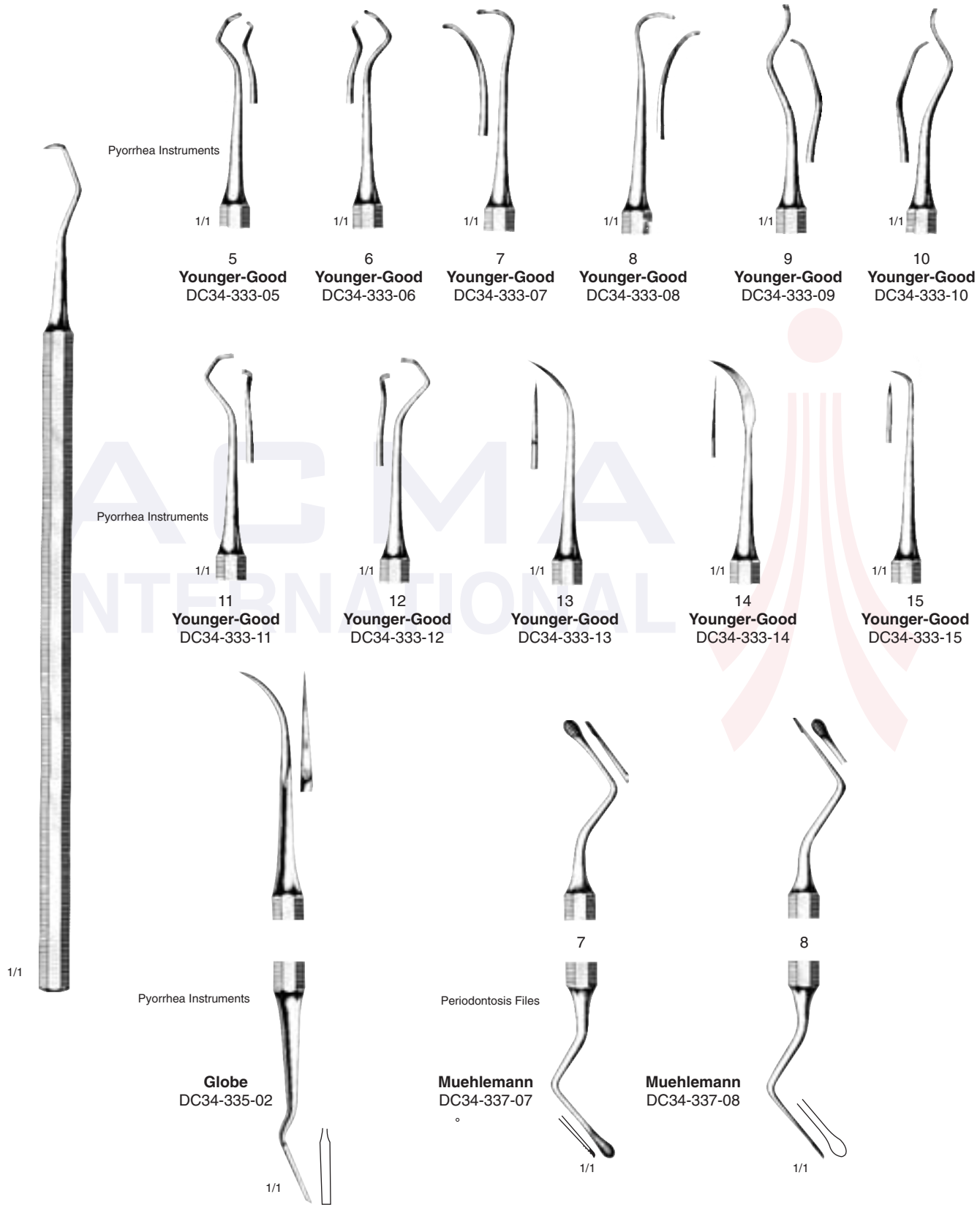

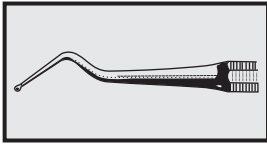

Scalers for Periodontosis and Pyorrhea

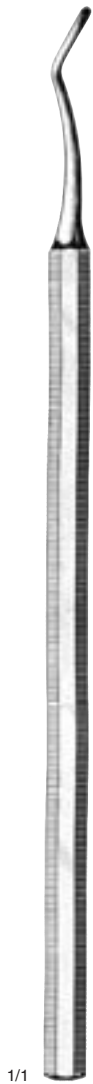

1/1

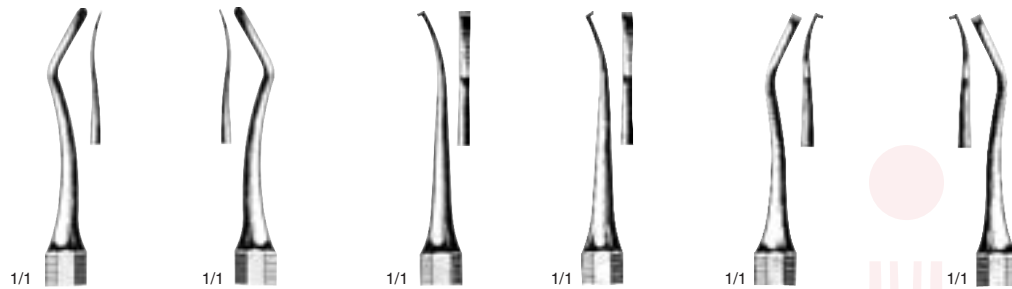

Black					
1	2	3	4	5	6
DC34-339-01	DC34-339-02	DC34-339-03	DC34-339-04	DC34-339-05	DC34-339-06
15	15	15	15	15	15
8	8	F	B	8	8
6	6			6	6
L	R			L	R

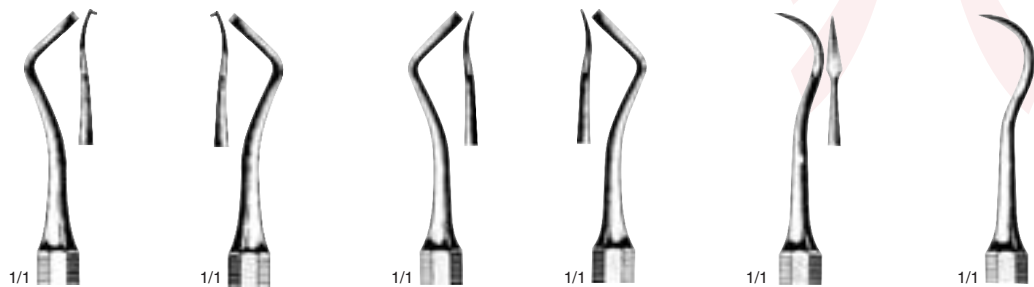

Black					
7	8	9	10	11	12
DC34-339-07	DC34-339-08	DC34-339-09	DC34-339-10	DC34-339-11	DC34-339-12
15	15	15	15	25	20
8	8	8	8		
6	12	12	12		
R	R	L	R		

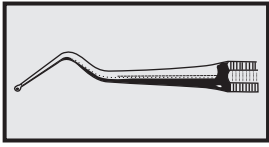

Scalers for Periodontosis and Pyorrhea



DC34-341-01 DC34-343-11 Pyorrhea Instruments

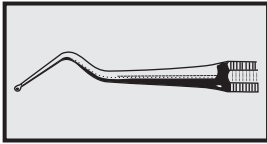

Scalers



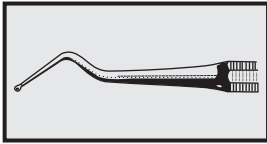

Scalers

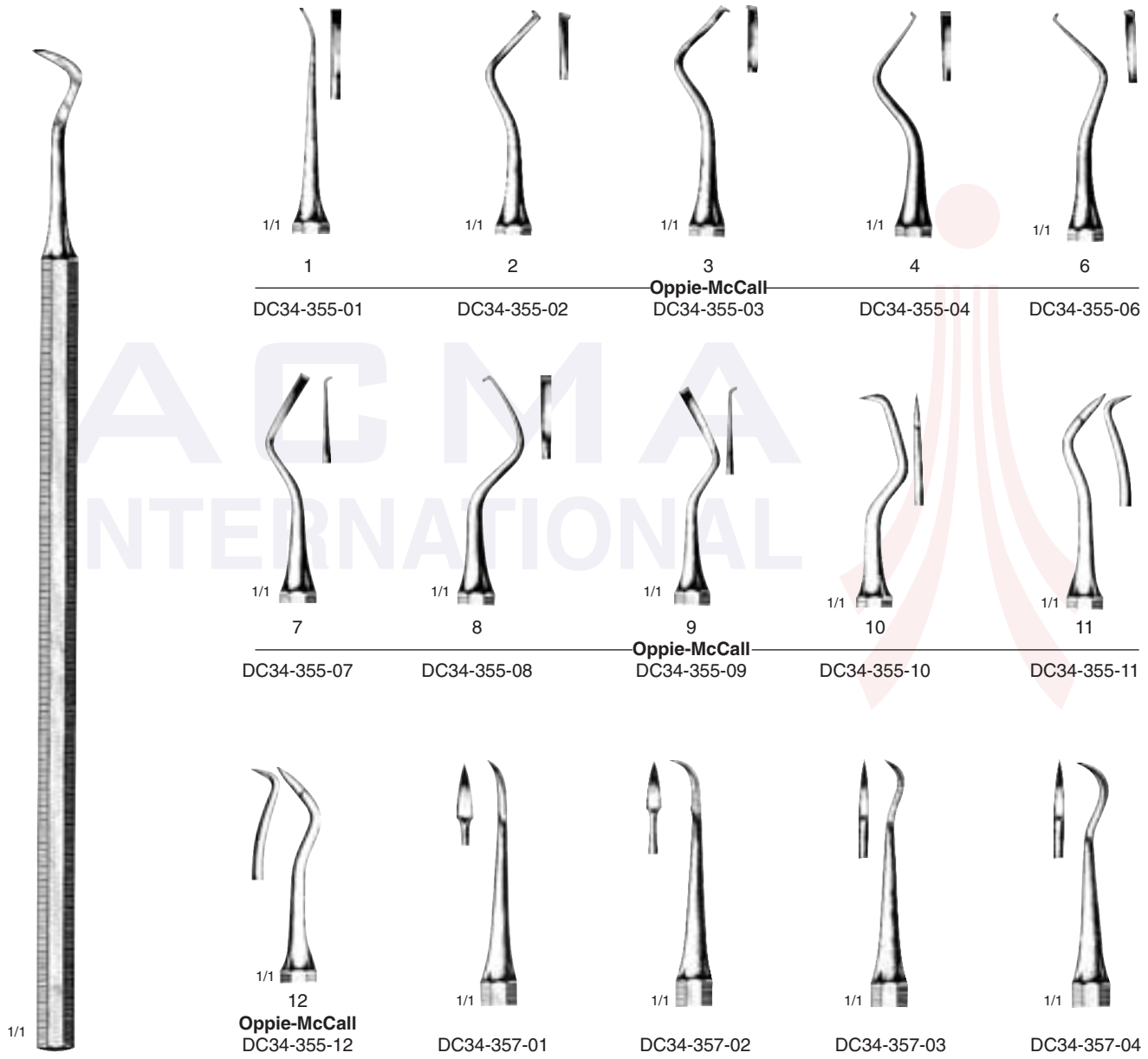

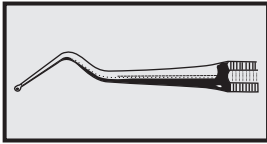

Scalers



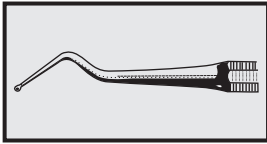

Scalers



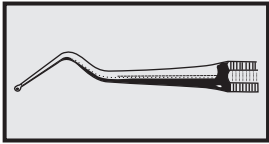

Periodonita Instruments

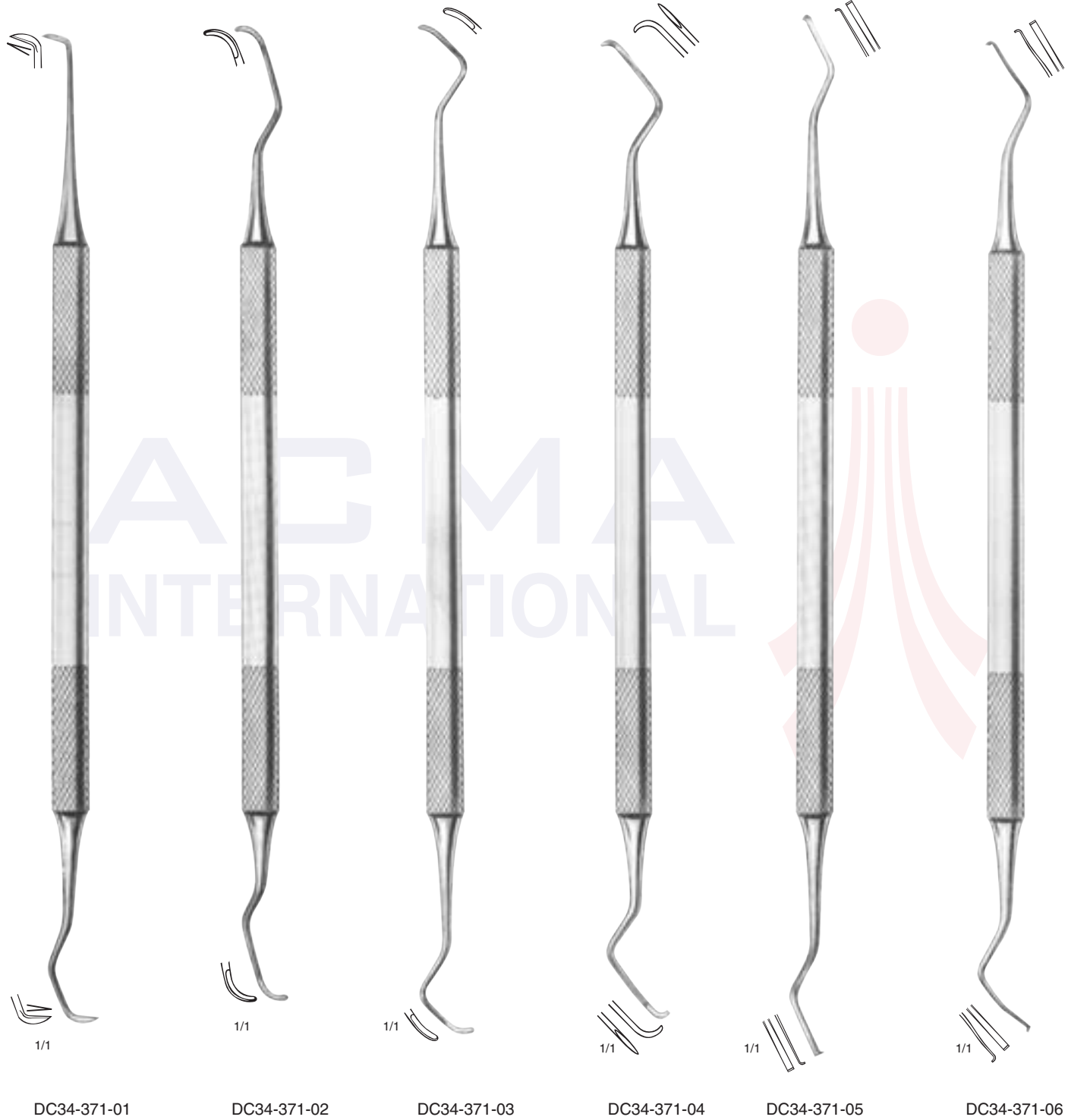

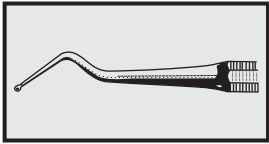

Periodonita Instruments



DC34-371-07

DC34-371-08

DC34-371-09

DC34-371-10

DC34-371-11

DC34-371-12

DC34-371-07	DC34-371-11	Gingivectomy Knives
	DC34-371-12	Scaler, double-ended

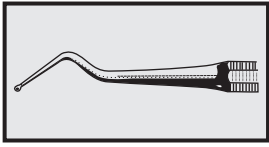

Periodonita Instruments

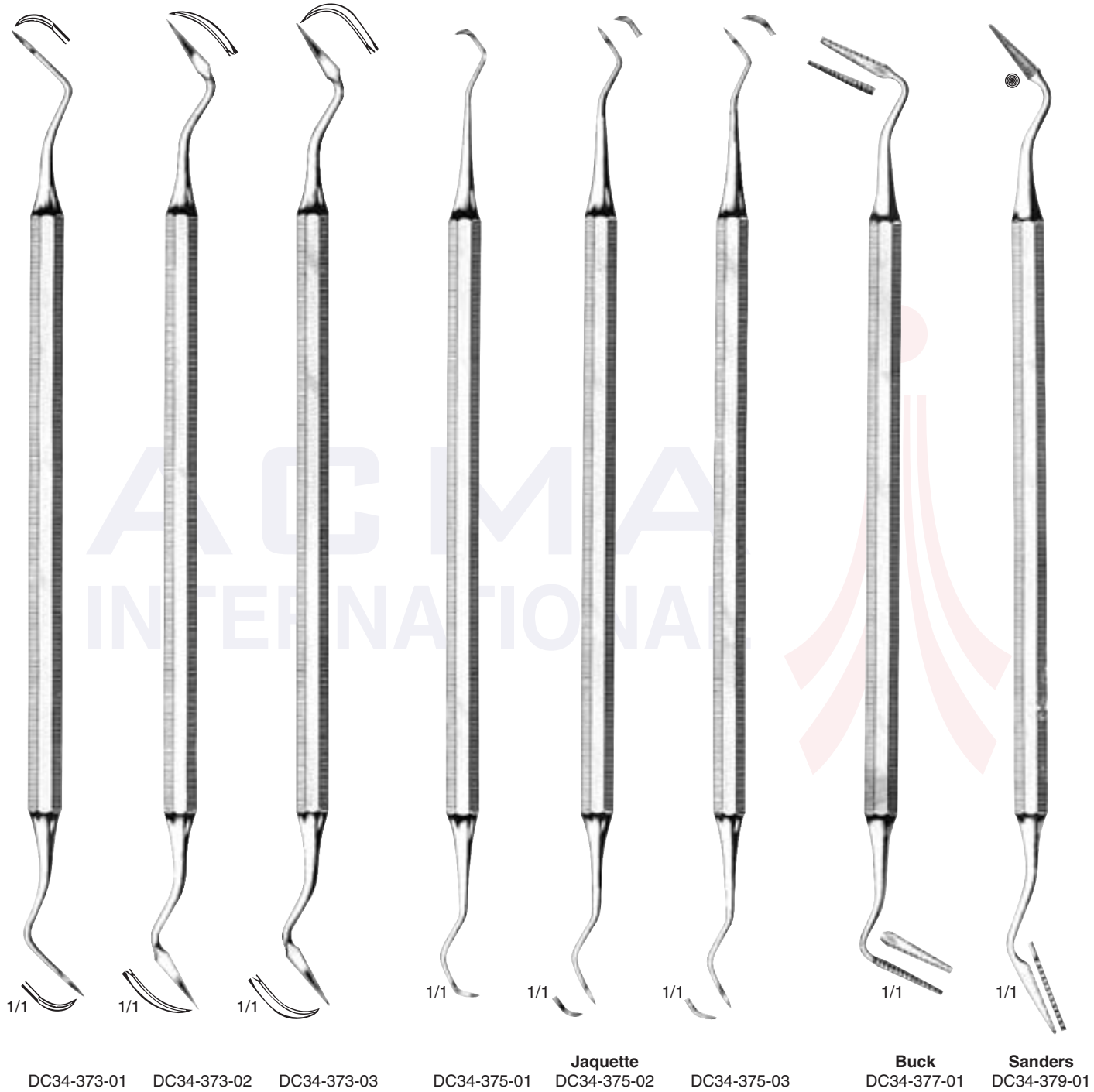

ACMA
INTERNATIONAL

DC34-373-01	DC34-375-03	Scalers double-ended
DC34-377-01	DC34-379-01	Interproximal Trimmers

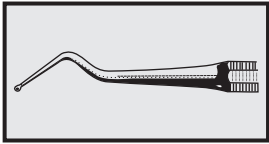

Periodonita Instruments



DC34-381-02 DC34-381-14 Scalers

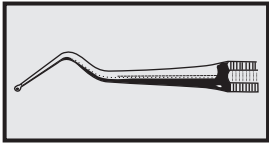

Special Instruments for Periodontosis and Pyorrhea.



DC34-383-01	DC34-385-02	Loops
DC34-387-01	DC34-389-02	Gum Probes with Eye

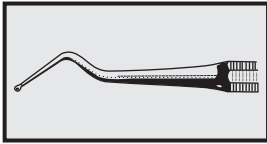

Instruments for Periodontitis Pyorrhea



1/1

1/1

1/1

1/1

1/1

Crane-Kaplan
DC27-173-30

Crane-Kaplan
DC27-175-30

DC34-393-01

DC34-395-01

DC34-395-02

Krenn
DC34-397-02

DC27-173-30	DC27-175-30	Pocket markers
DC34-393-01	DC34-397-02	Probes for measuring gum pockets

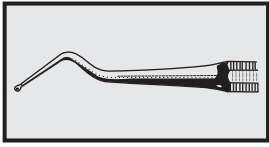

Scalers



DC34-399-01	DC34-399-07	Finishing Files
DC34-401-01	DC34-403-01	Loops
DC34-405-01	DC34-405-03	Gingivectomy Knives

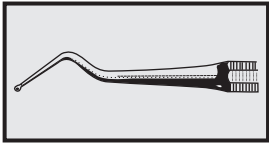

Periodontia Instruments



Mercitan
DC34-407-01 DC34-407-02

Ward-Kirkland
DC34-409-01 DC34-409-02 DC34-409-03 DC34-409-04 DC34-409-05

DC34-407-01 DC34-409-05 Scalers, Single-ended

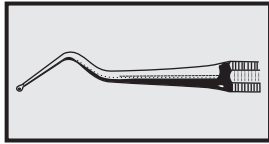

Chisels & Enamel Cleavers



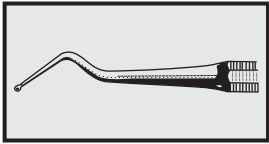

Wax, Porcelain and Modeling Carvers



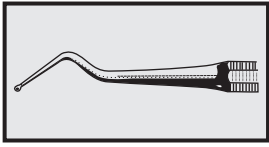

Wax, Porcelain and Modeling Carvers



3S
Hollenback
DC34-435-31

No. 5
DC34-437-01

Shooshan
DC34-439-01

DC34-441-01

DC34-443-01

1
Frahm
DC34-445-01

2
Frahm
DC34-445-02

3
Frahm
DC34-445-03

DC34-447-01

Roach
DC34-449-01

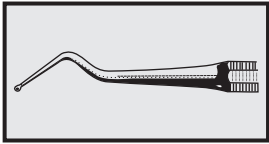

Wax, Porcelain and Modeling Carvers



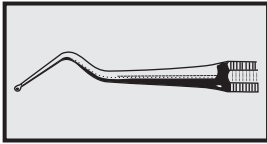

Wax, Porcelain and Modeling Carvers



Acker
DC34-465-01

Falck
DC34-467-01

Falck
DC34-469-01

Beale
DC34-471-01

Ermert
DC34-473-01

Ermert
DC34-475-01

Gisy-Wild
15 cm / 6"
DC34-477-15

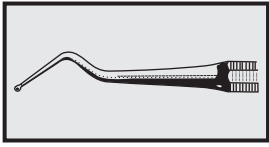

Wax Spatula, Wax Knives, Wax Spoons



Gritman

DC34-479-01

Gritman
DC34-481-01

Cerafix

DC34-483-01

Fahnenstock
13 cm / 5"
DC34-485-13

Fahnenstock
17 cm / 6 3/4"
DC34-485-17

Lessmann
13 cm / 5"
DC34-487-13

Lessmann
17 cm / 7"
DC34-487-17

Antkoviak
12.5 cm / 5"
DC34-489-12

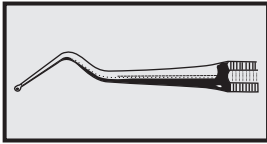

Prosthetics, Orthodontia

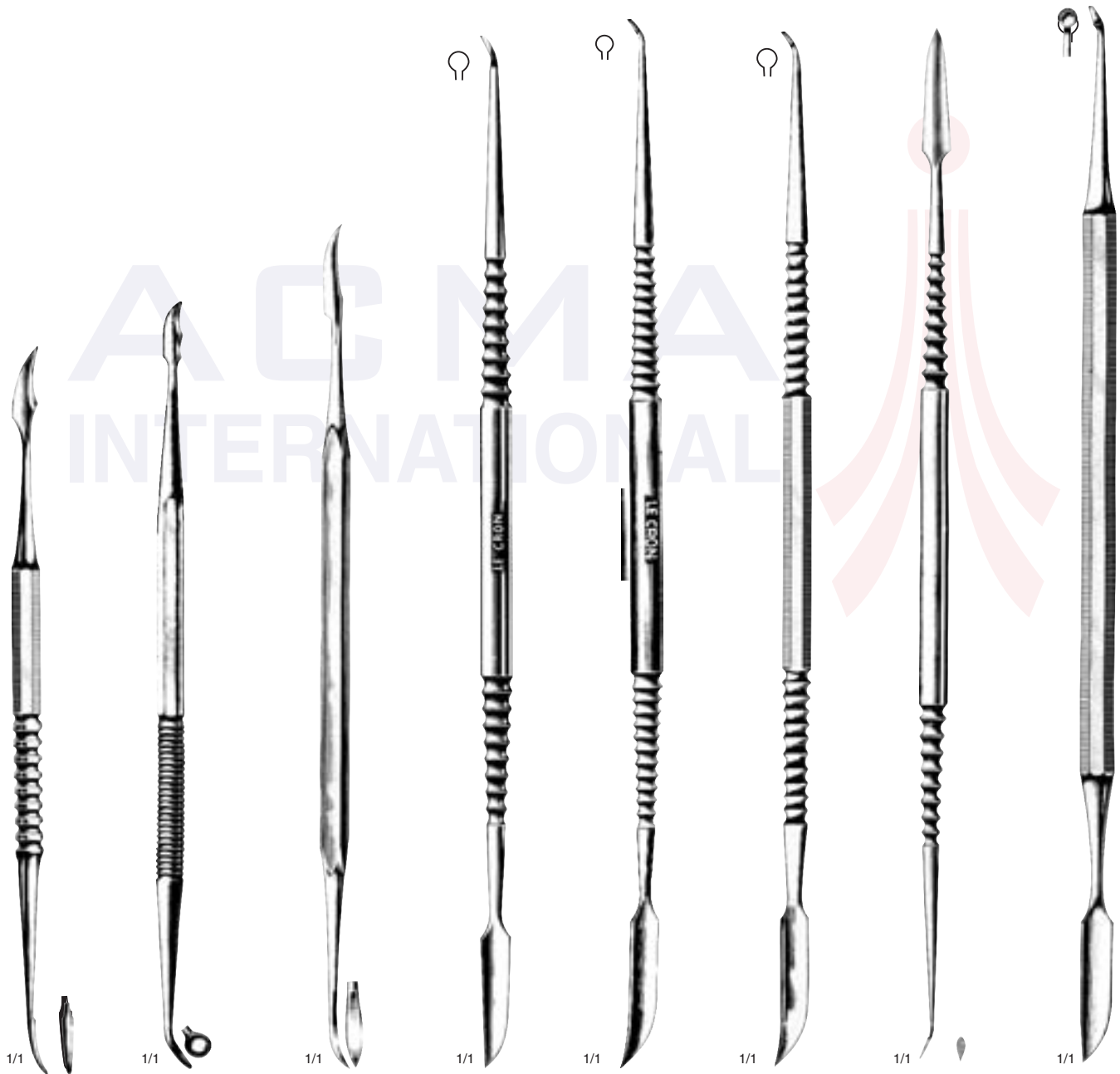

Zahle
DC34-491-01

Hylin
DC34-493-01

Zahle
DC34-495-01

1/1
Le Cron
DC34-497-01

1/1
Le Cron
DC34-499-01

1/1
Le Cron
DC34-501-01

1/1
Le Cron
DC34-503-01

1/1
Le Cron
DC34-505-01

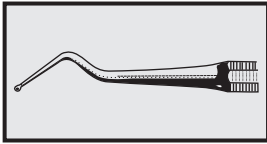

Instruments For Crown Work

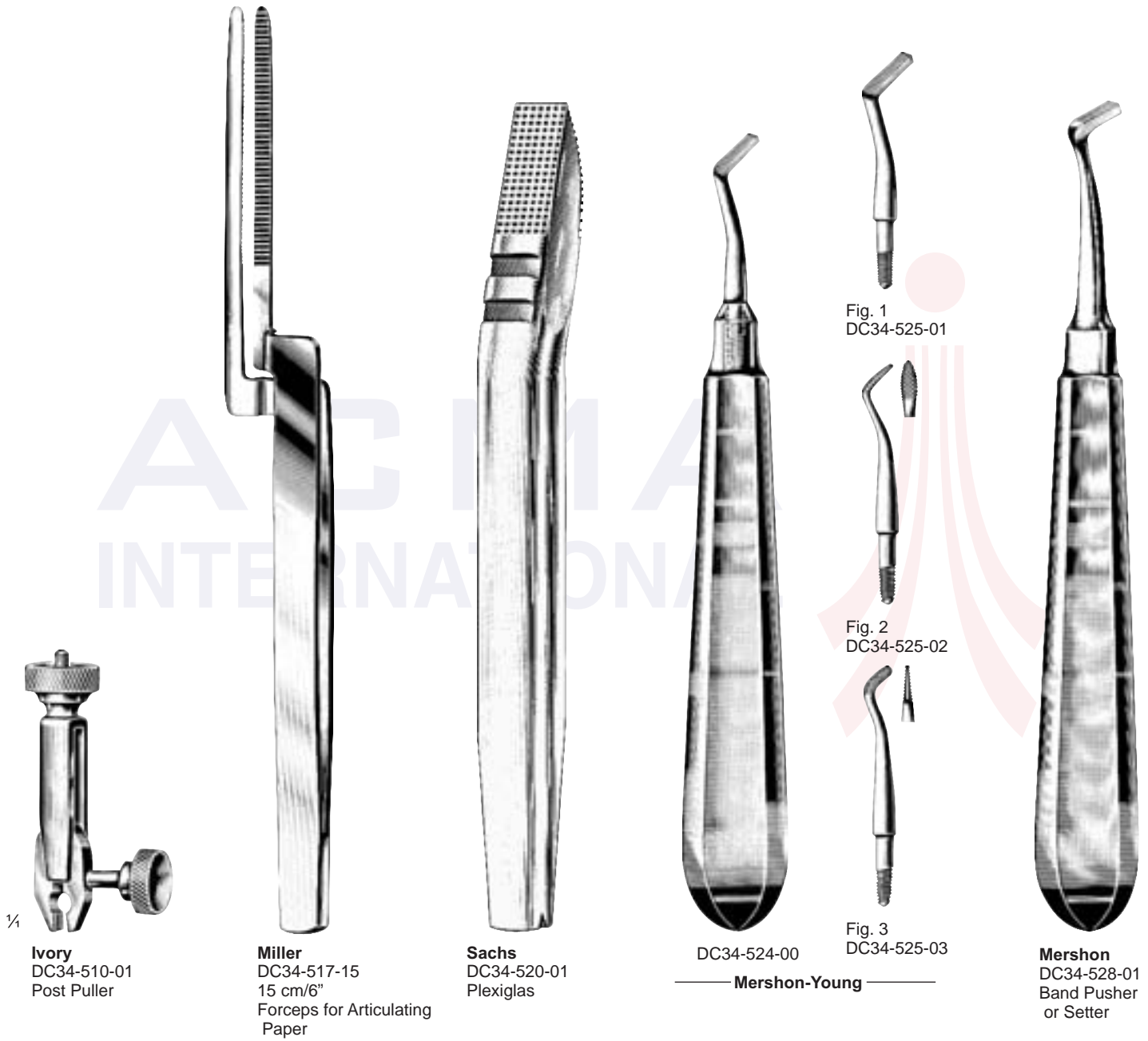

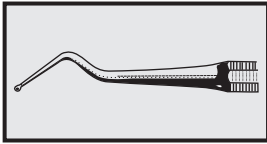

Instruments for Crown Work

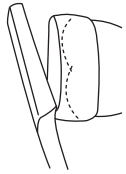

Swivel Lid for removing pins easily

2/3

DC34-555-00
55 mm Ø 17 mm



1/4

DC34-530-01



Steiner
DC34-532-01



Mod. Paris
DC34-5DC34-01



1/4

Fig.

1	DC34-552-01
2	DC34-552-02
3	DC34-552-03
4	DC34-552-04
5	DC34-552-05
6	DC34-552-06
7	DC34-552-07
8	DC34-552-08
9	DC34-552-09
10	DC34-552-10
14	DC34-552-14
15	DC34-552-15



DC34-540-01



DC34-549-30
10 m/32 ft. 10 in. x 0.3 mm Ø



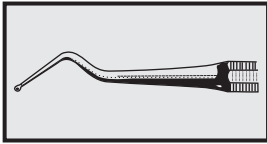

Instruments for Crown Work,
Vulcanite Scrapers





DC34-604-00
Crown Remover



DC34-606-00
Crown Remover

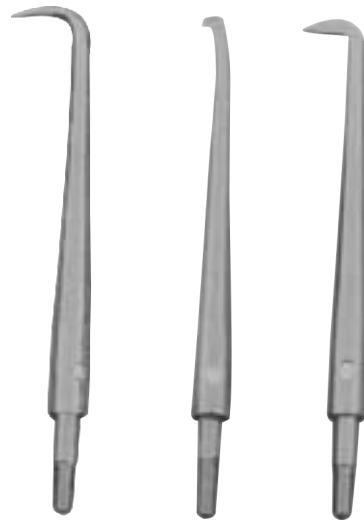

DC34-612-00
Crown Spreader



DC34-608-00
Crown Remover

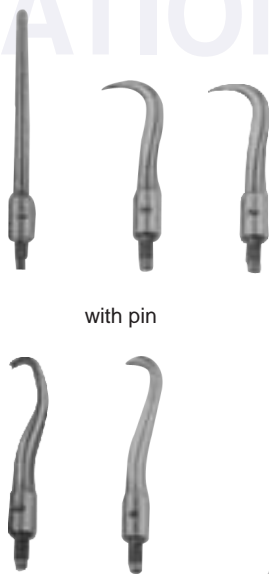

with pin



DC34-610-00
Crown Remover

