

5

Forceps

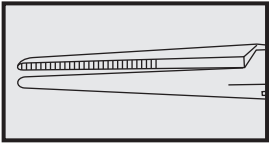

Fine Hemostatic Forceps



Halsted-Mosquito

1 x 2 teeth



DC05-001-12
12.5cm/5"



DC05-001-14
14cm/5½"



DC05-003-12
12.5cm/5"



DC05-003-14
14cm/5½"



DC05-005-12
12.5cm/5"



DC05-005-14
14cm/5½"



DC05-007-12
12.5cm/5"



DC05-007-14
14cm/5½"



Halsted-Mosquito

1 x 2 teeth

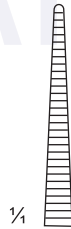

DC05-009-18
18cm/7"



DC05-009-21
21cm/8¼"



DC05-011-18
18cm/7"



DC05-011-21
21cm/8¼"

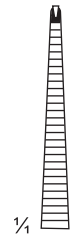

DC05-013-18
18cm/7"



DC05-013-21
21cm/8½"



DC05-015-18
18cm/7"



DC05-015-21
21cm/8¼"

Fine Hemostatic Forceps

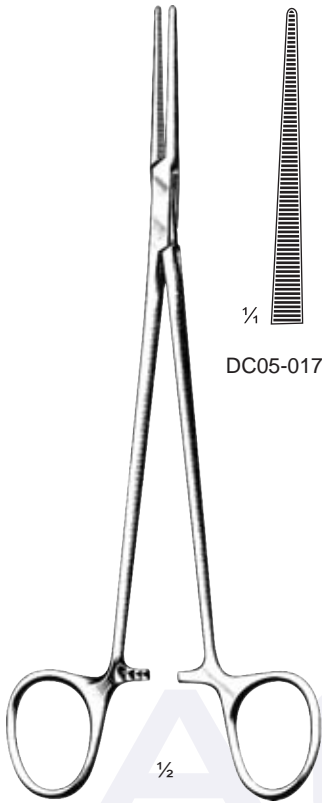
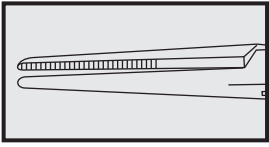

Heiss
20cm/8"

1/4

DC05-017-20

DC05-019-20

DC05-021-20

ACMA
INTERNATIONAL



Bengolea

1/4

DC05-023-20
20cm/8"

DC05-023-26
26cm/10 1/4"

DC05-025-20
20cm/8"

DC05-025-26
26cm/10 1/4"

1 x 2 teeth

1/4

DC05-027-20
20cm/8"

DC05-027-26
26cm/10 1/4"

DC05-029-20
20cm/8"

DC05-029-26
26cm/10 1/2"

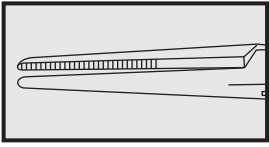

Fine Hemostatic & Artery Forceps



Hartmann
(Baby-Mosquito)
9.5cm/3 3/4"

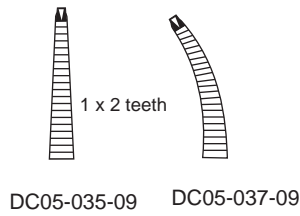
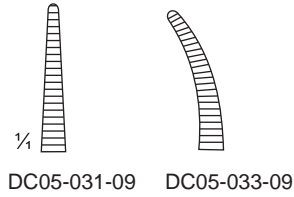

Micro-Mosquito

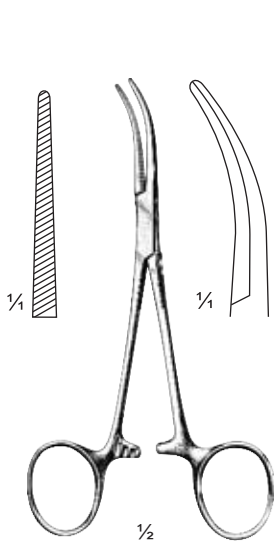
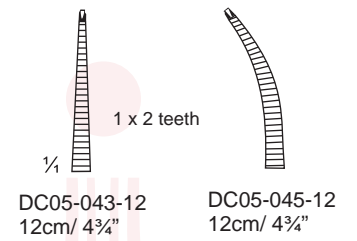
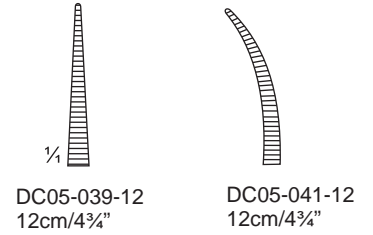

Mosquito-Dandy
DC05-047-12
12 cm/4 3/4"

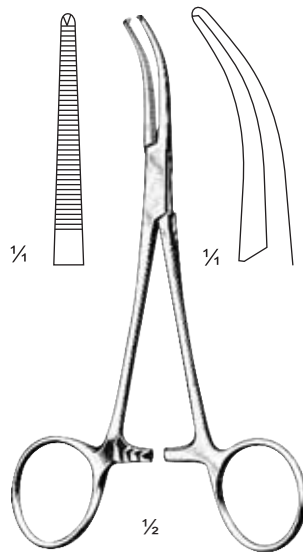

Dandy
DC05-049-14
1 : 2 Teeth

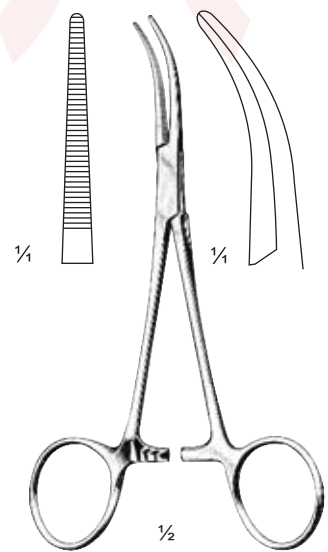

Dandy
DC05-051-14
14 cm/5 1/2"

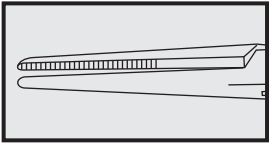

Fine Hemostatic & Artery Forceps

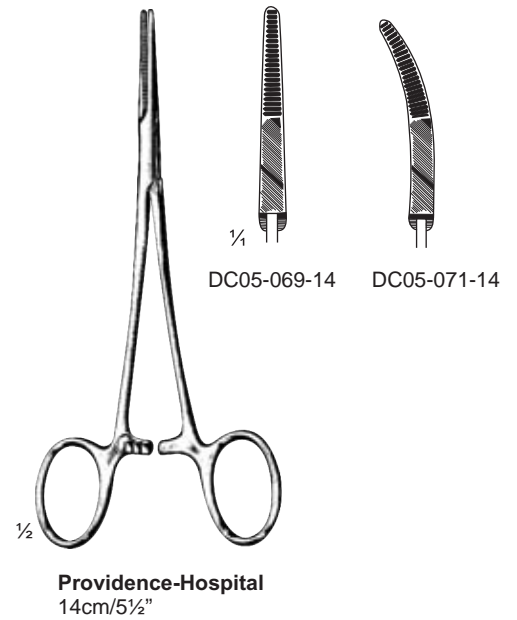
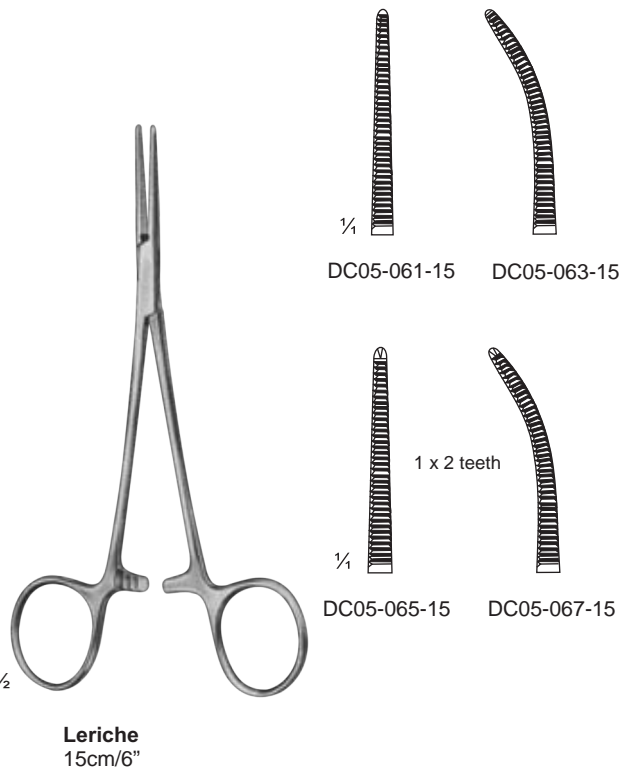
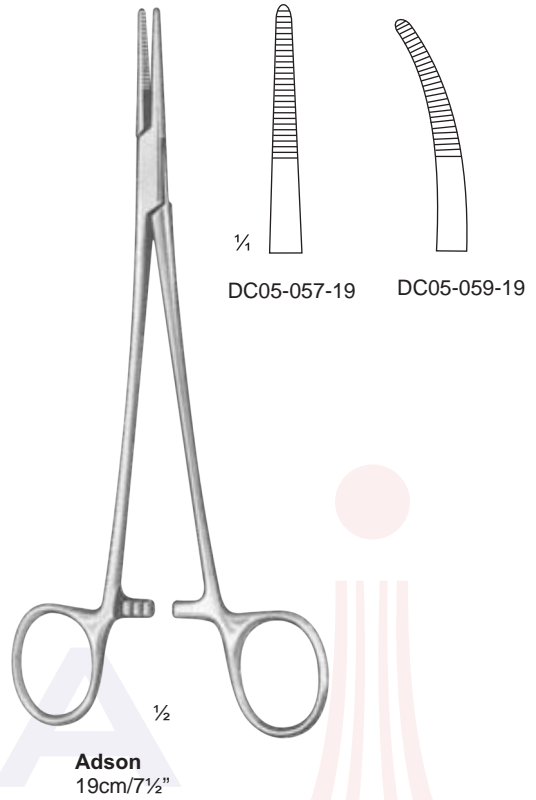
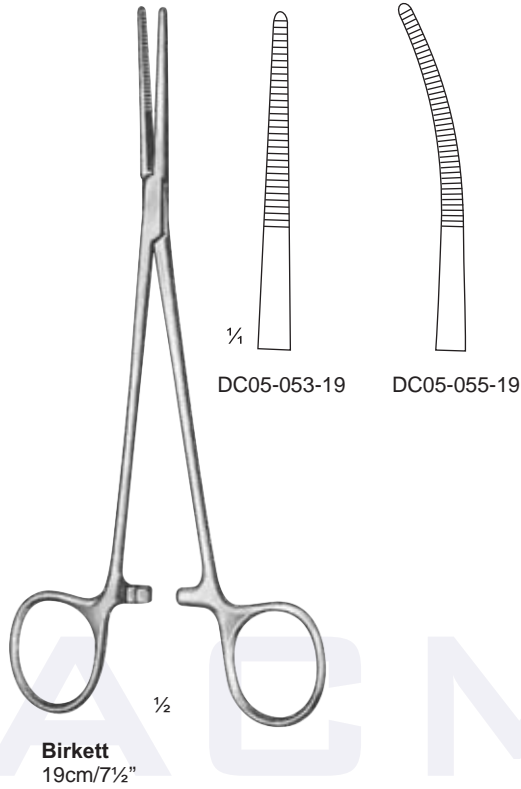

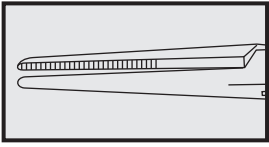

Fine Hemostatic Forceps

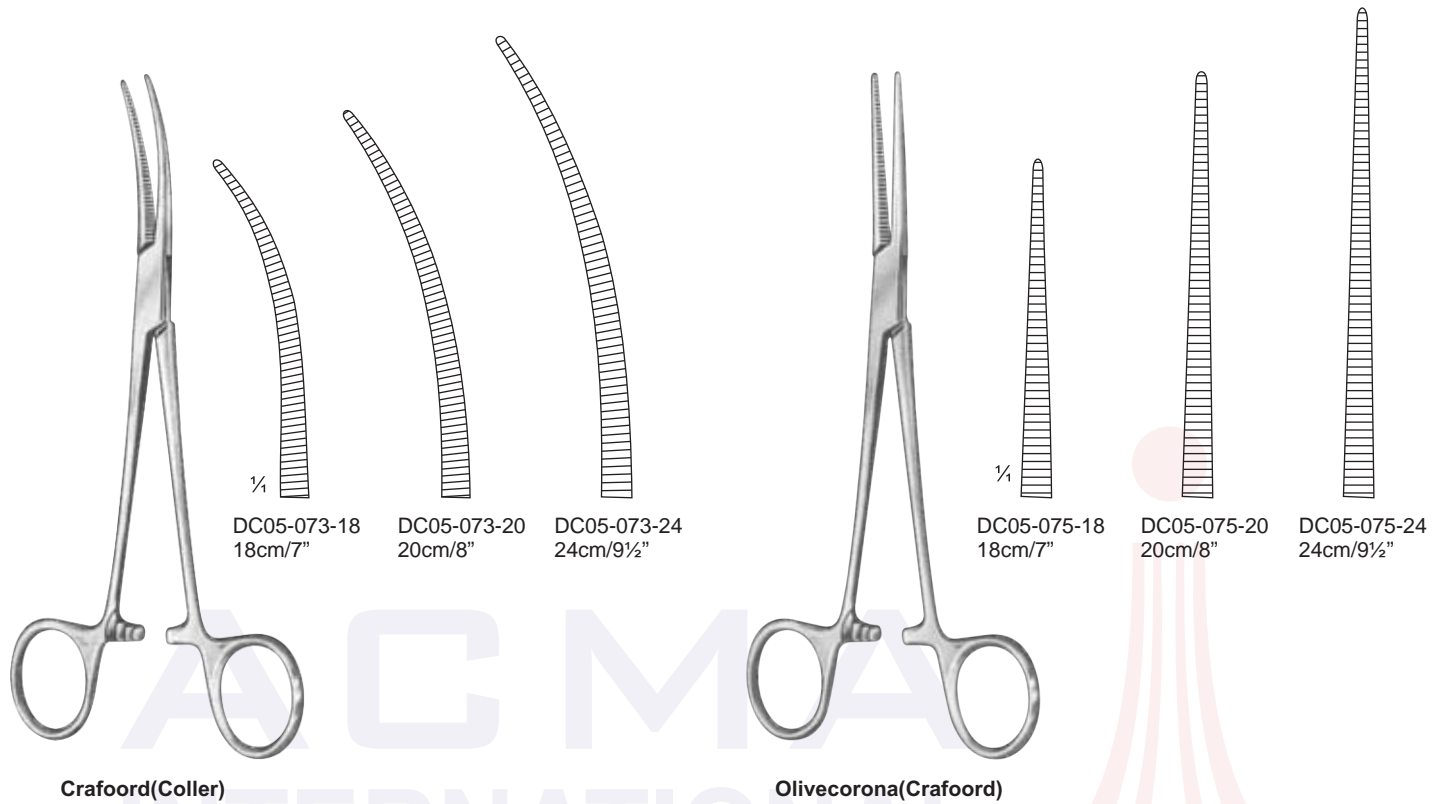

ACMA
INTERNATIONAL

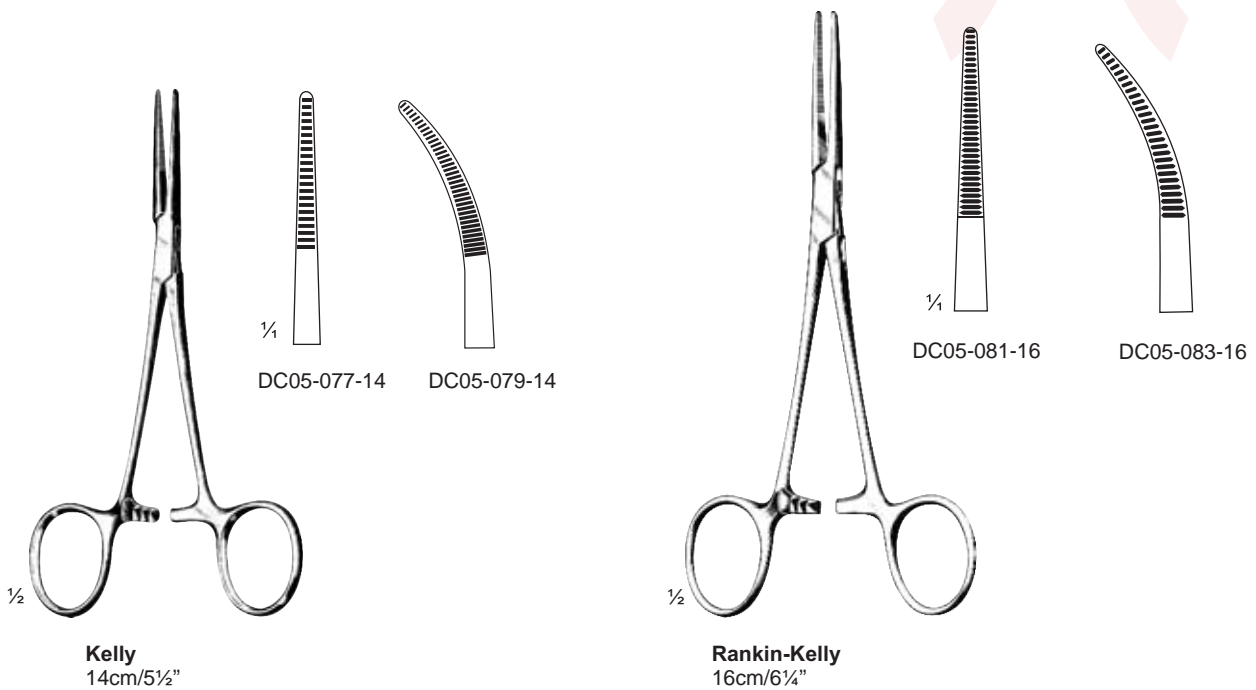

Fine Hemostatic Forceps

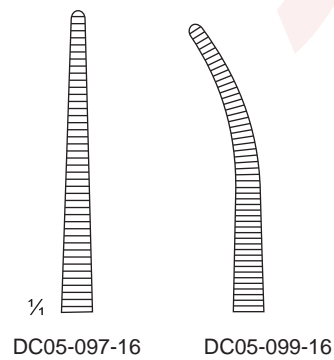
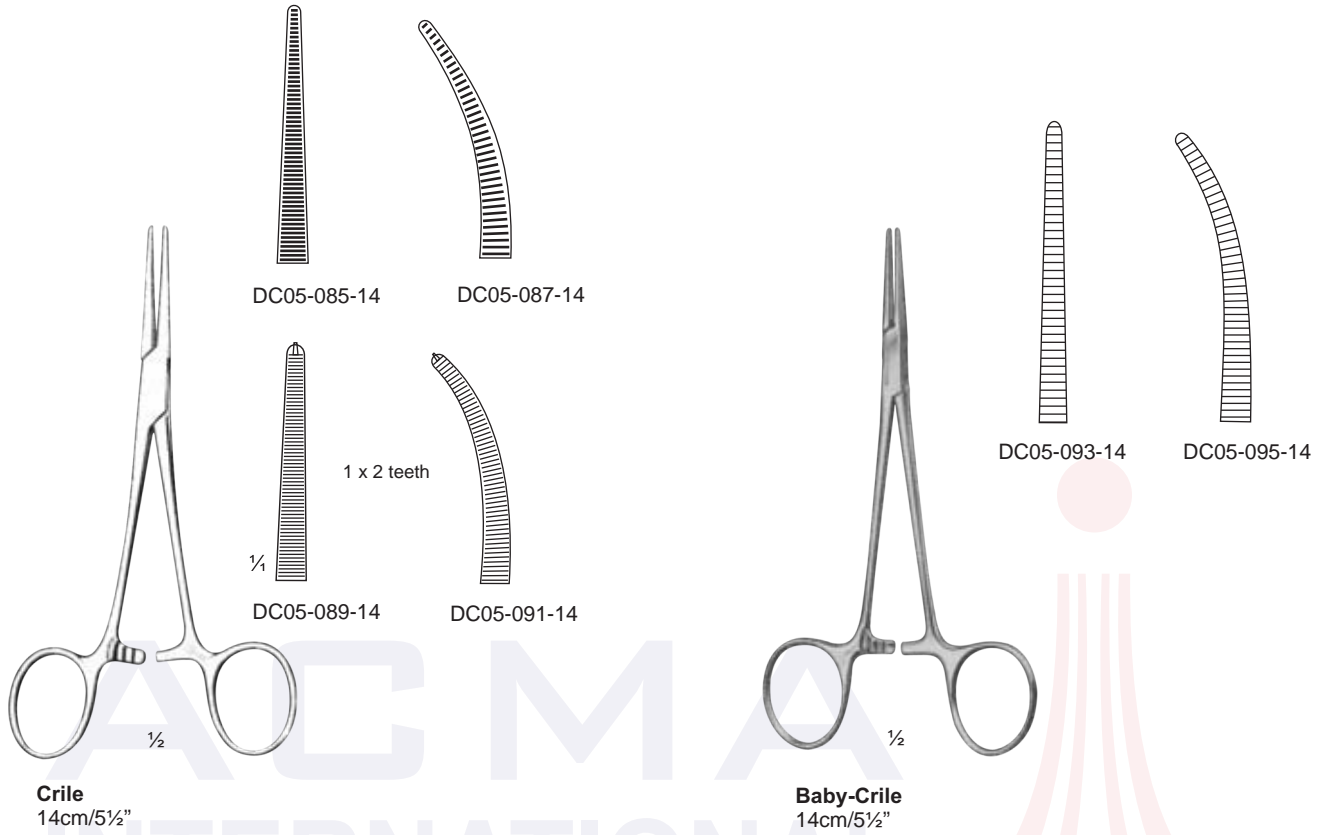
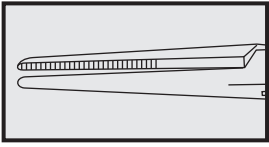

Hemostatic Forceps

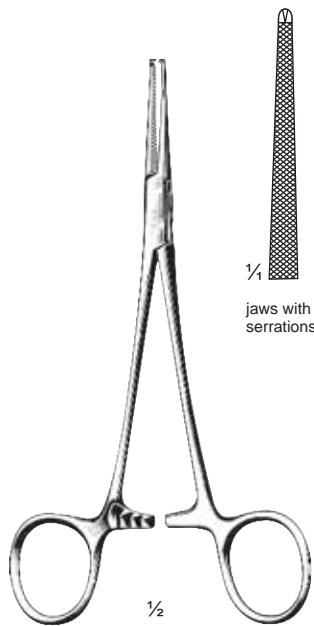
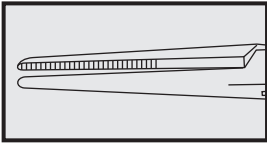

Dixon-Lovelace
DC05-109-16
16cm/6 1/4"
1 x 2 teeth

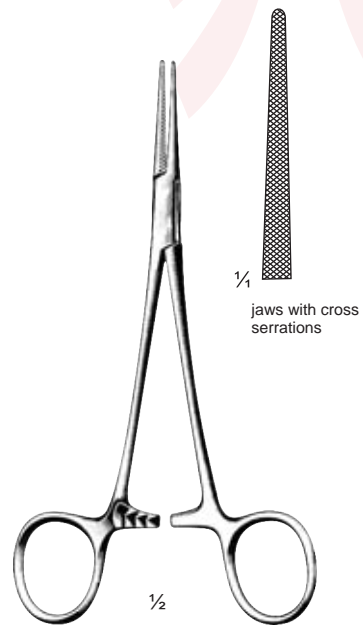

Dixon-Lovelace
DC05-111-16
16cm/6 1/4"

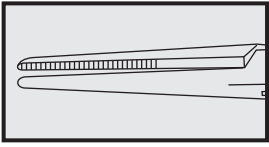

Hemostatic Forceps

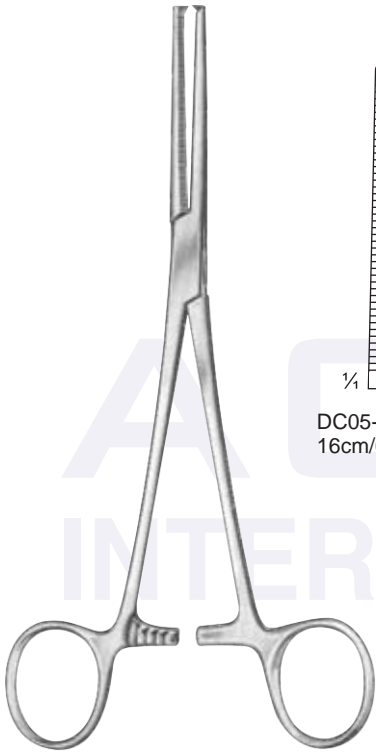

Rochester-Ochsner

1/4

DC05-113-16
16cm/6 1/4"

DC05-113-18
18cm/7"

DC05-113-20
20cm/8"

DC05-113-22
22cm/8 3/4"

DC05-113-24
24cm/9 1/2"

DC05-113-26
26cm/10 1/4"

DC05-113-28
28cm/11"

1/4

DC05-115-16
16cm/6 1/4"

DC05-115-18
18cm/7"

DC05-115-20
20cm/8"

DC05-115-22
22cm/8 3/4"

DC05-115-24
24cm/9 1/2"

DC05-115-26
26cm/10 1/4"

DC05-115-28
28cm/11"

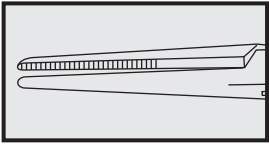

Hemostatic Forceps

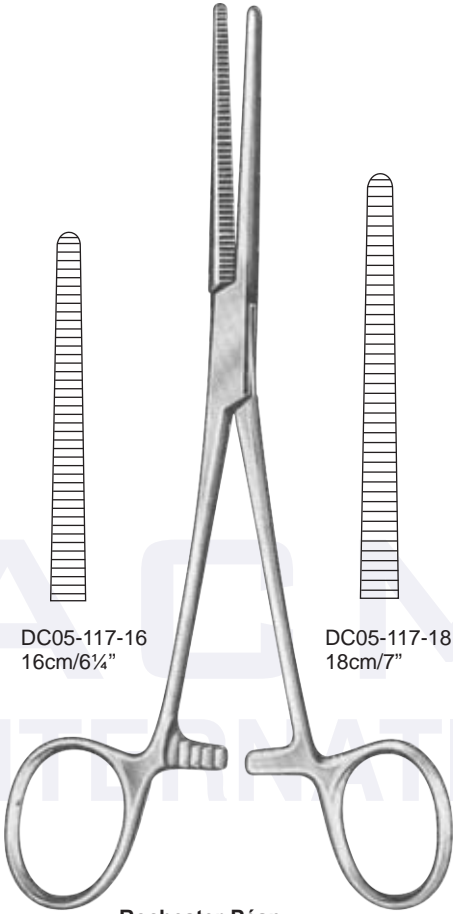
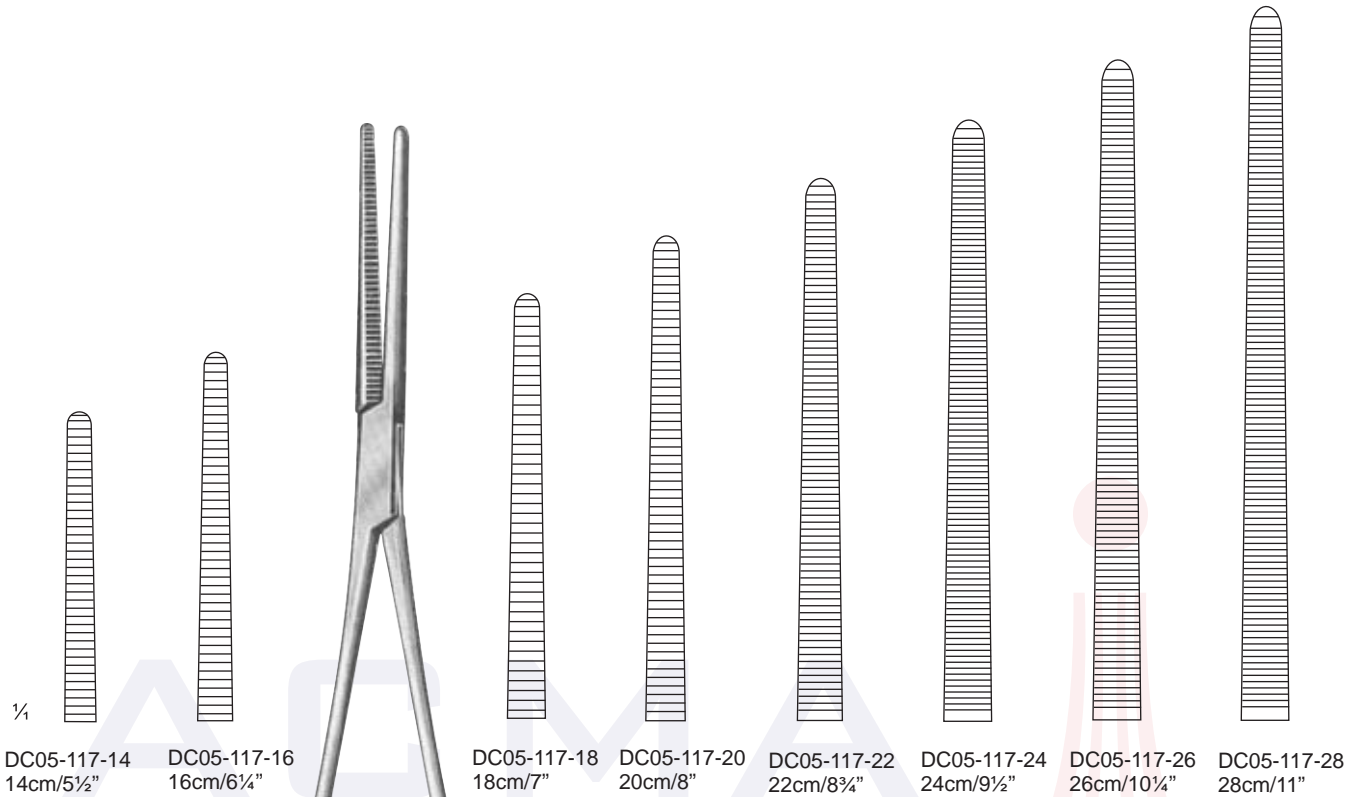

Rochester-Péan

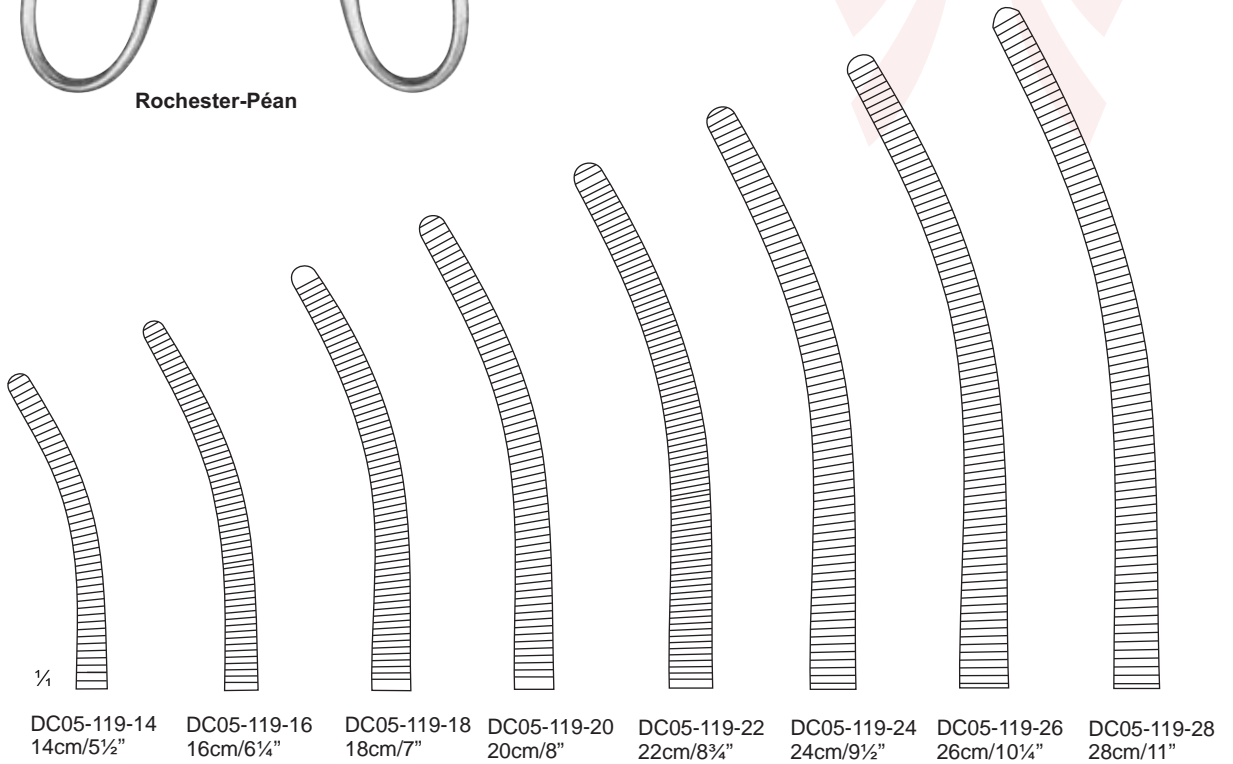

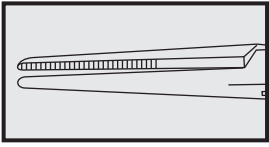

Pén

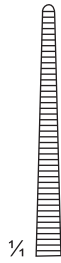

DC05-121-13
13 cm/5"



DC05-121-14
14 cm/5½"



DC05-121-16
16 cm/6¼"



DC05-123-13
13cm/5"



DC05-123-14
14cm/5½"

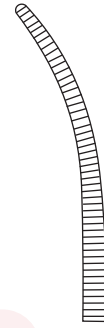

DC05-123-16
16cm/6¼"

ACMA
INTERNATIONAL



Rochester-Carmalt



DC05-125-16
16cm/6¼"



DC05-125-18
18.5cm/7¼"



DC05-125-20
20.5cm/8"



DC05-127-16
16cm/6¼"



DC05-127-18
18.5cm/7¼"

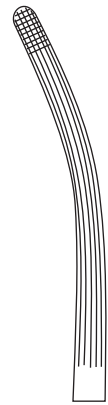

DC05-127-20
20.5cm/8"

Hemostatic Forceps

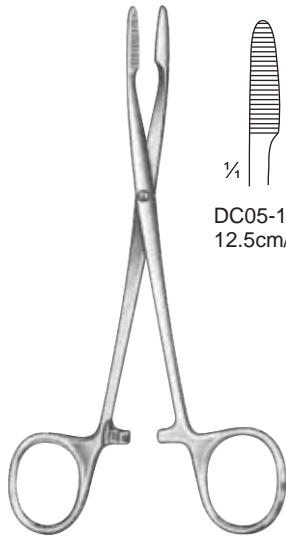
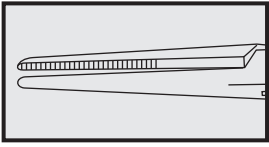

Péan



DC05-129-12
12.5cm/5"



DC05-129-14
14cm/5½"



DC05-129-16
16cm/6½"

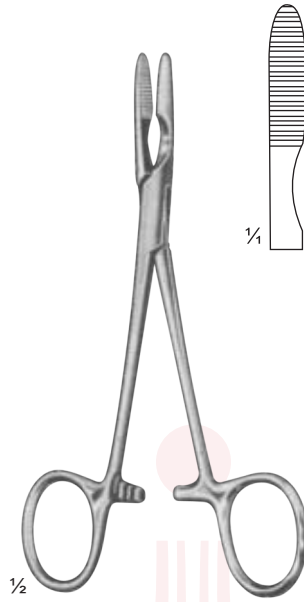

Péan

DC05-131-14
14.5cm/5¾"



ACMA
INTERNATIONAL



Spencer-Wells (Jones)

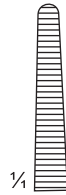

DC05-133-13
13 cm/5"



DC05-133-14
14 cm/5½"



DC05-133-15
15 cm/6"



DC05-133-20
20 cm/8"



DC05-135-13
13 cm/5"



DC05-135-14
14 cm/5½"



DC05-135-15
15 cm/6"



DC05-135-20
20 cm/8"

Hemostatic Forceps

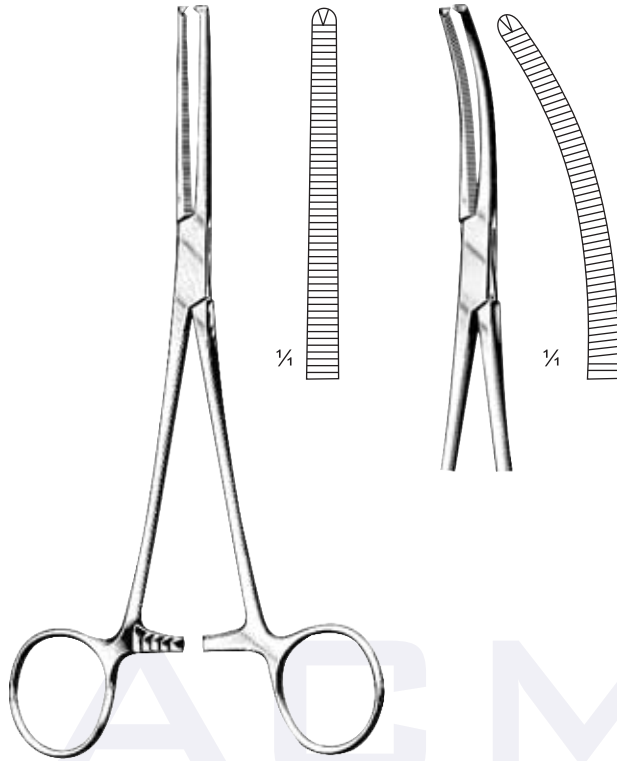
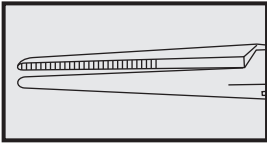

Kocher (Ochsner)

straight	1 : 2		curved
	cm	in.	
DC05-137-14	14	5 ½	DC05-139-14
DC05-137-16	16	6 ¼	DC05-139-16
DC05-137-18	18	7	DC05-139-18
DC05-137-20	20	8	DC05-139-20
DC05-137-22	22	8 ¾	DC05-139-22
DC05-137-24	24	9 ½	DC05-139-24
DC05-137-26	26	10 ¼	DC05-139-26
DC05-137-30	30	12	DC05-139-30

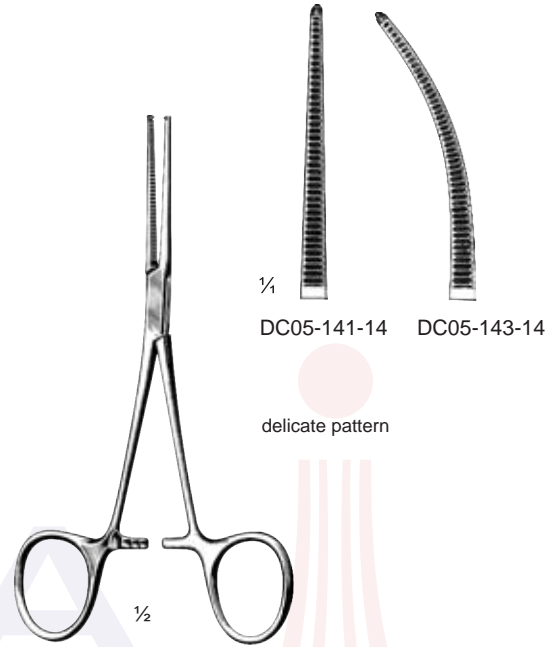

Kocher-Fine
14.5cm/5¾"



Kocher

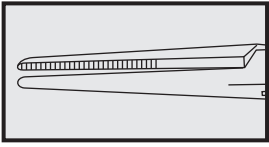

Dissecting and Hemostatic Forceps

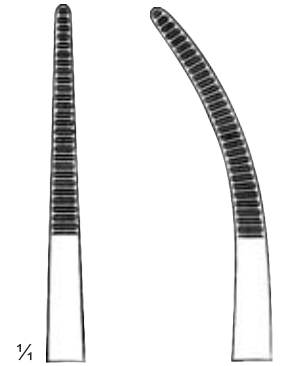
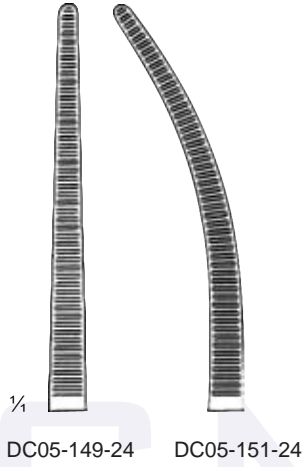
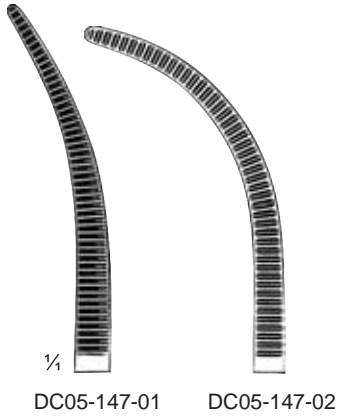

cm	inch.	DC05-153-21	DC05-155-21
21	8 1/4		
26	10 1/4		

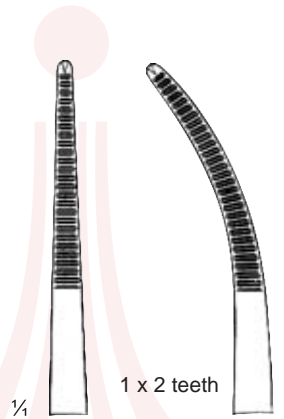

cm	inch.	DC05-157-21	DC05-159-21
21	8 1/4		
26	10 1/4		



Zenker
30cm/12"

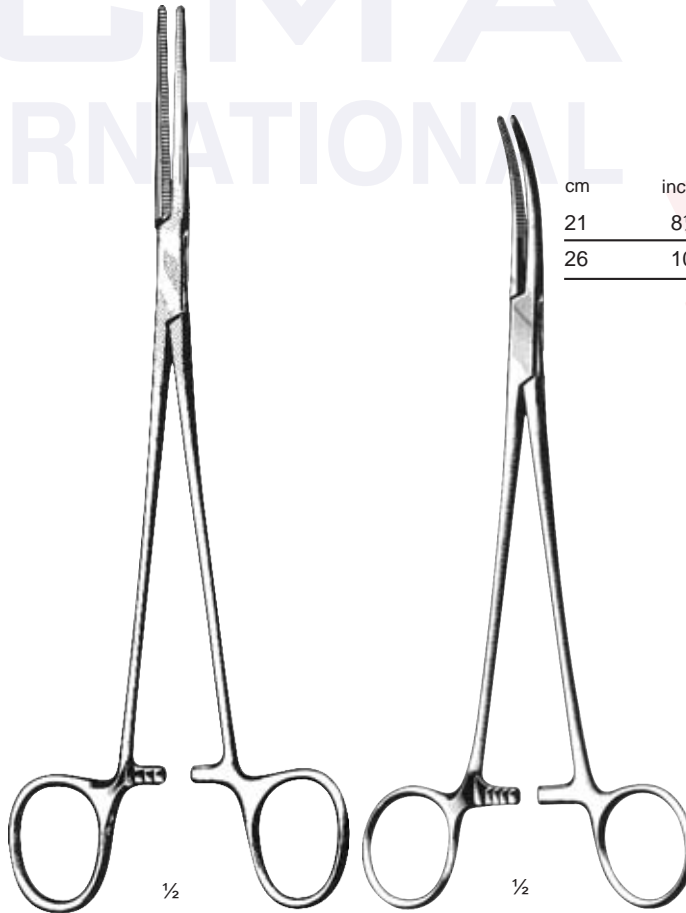

Roberts
24cm/9 1/2"



Toennis

Dissecting and Hemostatic Forceps

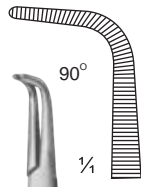
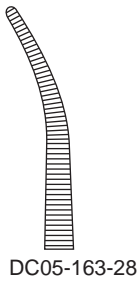
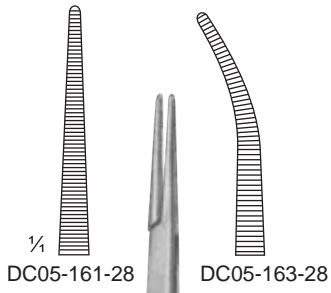
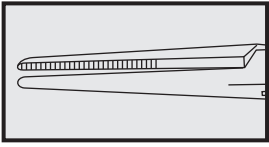

Bridge
28cm/11"



Meeker
DC05-165-28
28cm/11"



Lawrence
DC05-167-28
28cm/11"

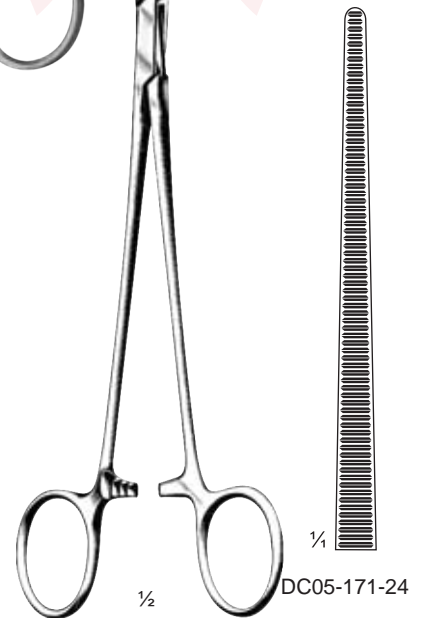
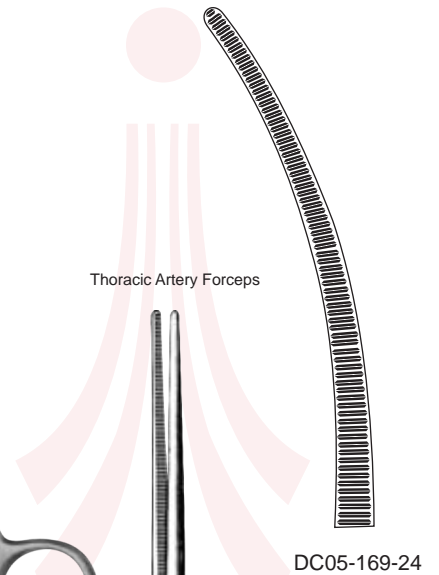

Sarot
24cm/9½"

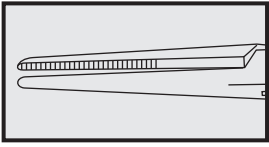

Dissecting, Hemostatic and Ligature Forceps



Rumel
23cm/9"

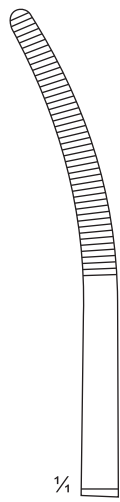

DC05-173-01



DC05-173-02

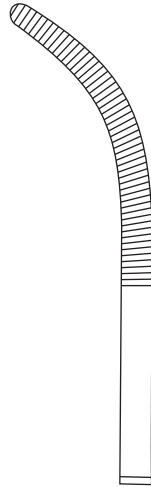

DC05-173-03

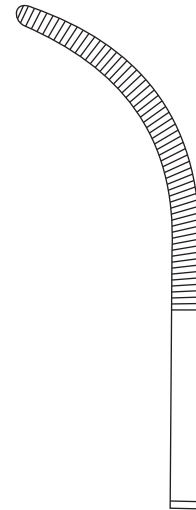

DC05-173-04

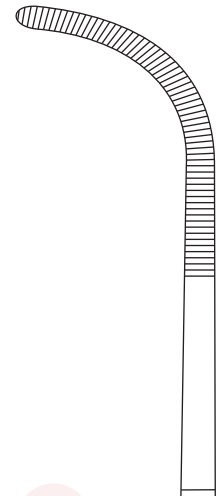

DC05-173-05

ACMA
INTERNATIONAL

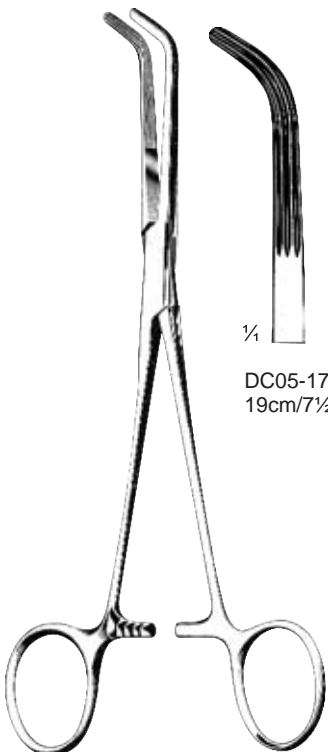
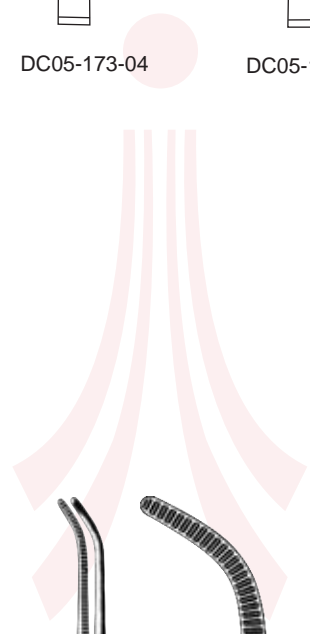

Lahey



DC05-175-19
19cm/7½"



DC05-175-23
23cm/9"



½



¼

Mixer
DC05-177-23
23cm/9"

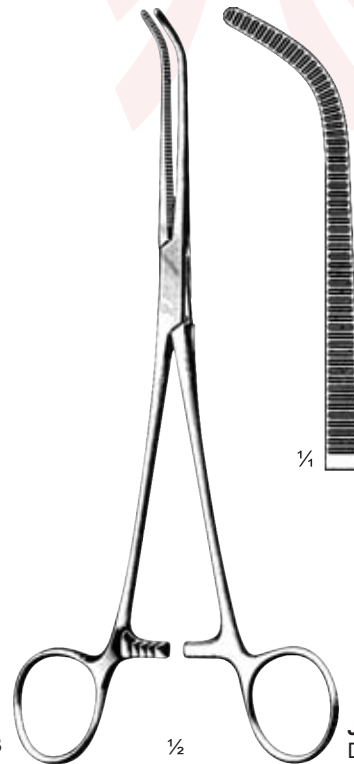

½



¼

Johns-Hopkins
DC05-179-20
20cm/8"

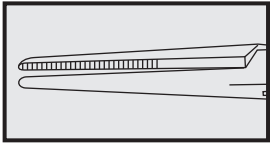

Dissecting, Hemostatic and Ligature Forceps



Kantrowitz

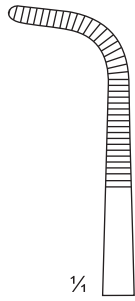

DC05-181-20
20cm/8"

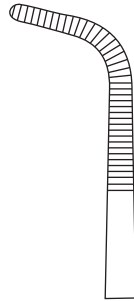

DC05-181-24
24cm/9½"

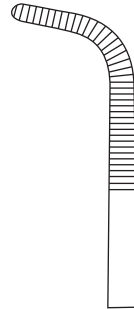

DC05-181-28
28cm/11"



Baby-Adson
DC05-183-18
18cm/7"

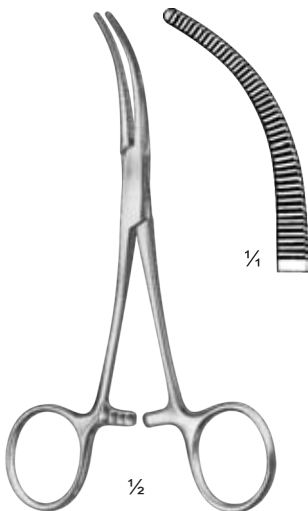

Baby-Overholt
DC05-185-13
3.5cm/5¼"

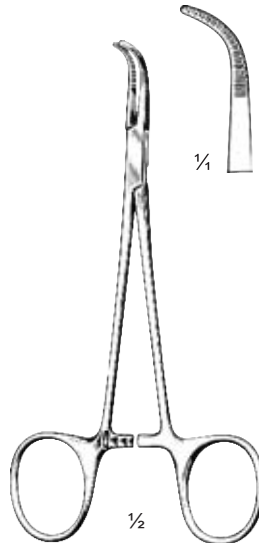

Micro-Adson
DC05-187-13
14cm/5½"

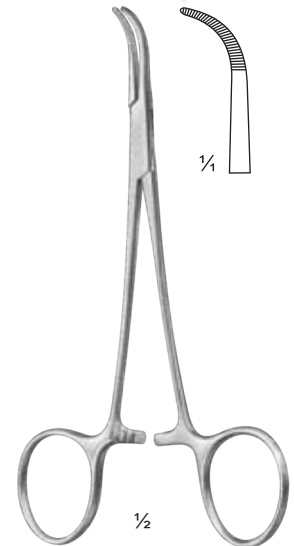

Baby-Adson
DC05-189-14
14cm/5½"

Dissecting, Hemostatic and Ligature Forceps

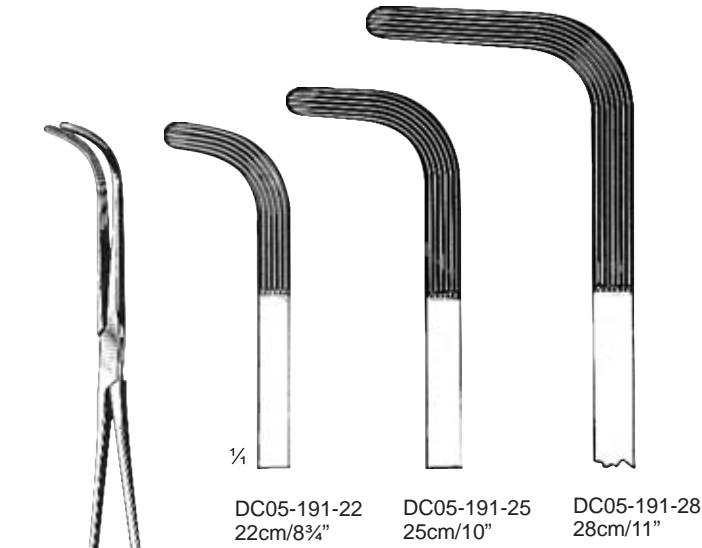
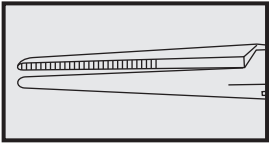

Also Gall Duct Clamps



Mixer

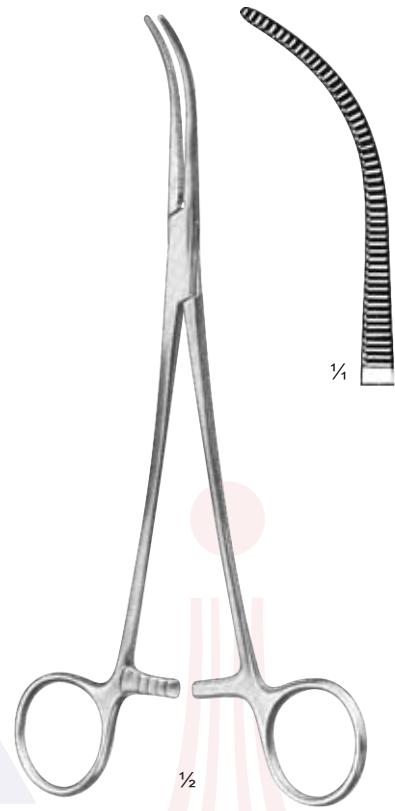

Overholt-Mixer
DC05-193-21
21cm/8¼"

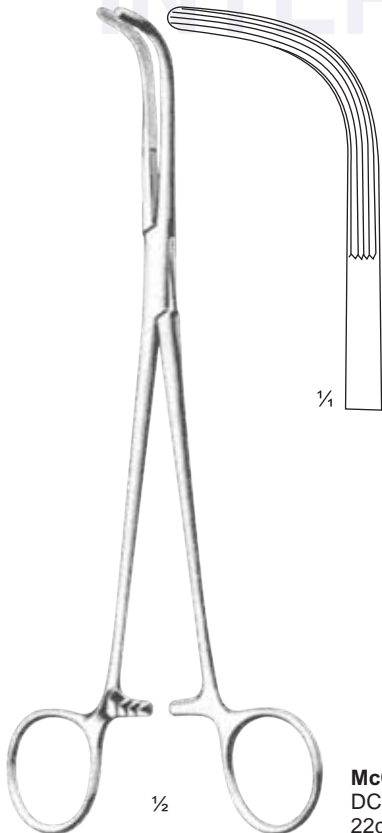

McQuigg-Mixer
DC05-195-22
22cm/8¾"

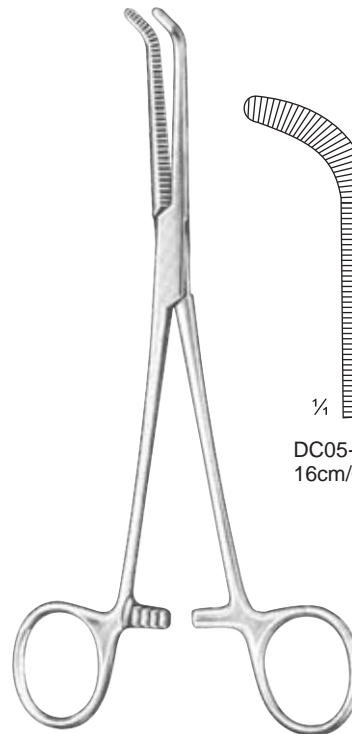

Mixer

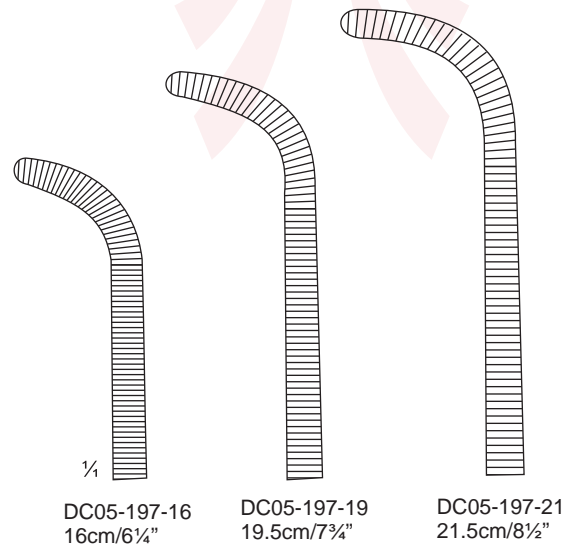

Also Gall Duct Clamps

Dissecting, Hemostatic and Ligature Forceps

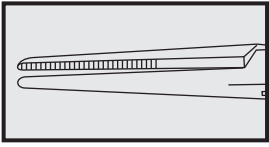

Gemini-Mini (Mixer)

DC05-199-18
18cm/7"

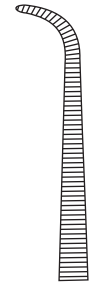

DC05-199-22
22cm/8 3/4"

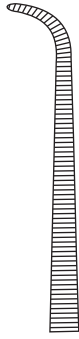

DC05-199-25
25cm/10"

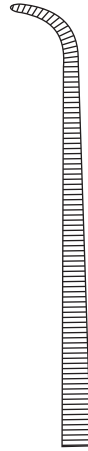

DC05-199-28
28cm/11"

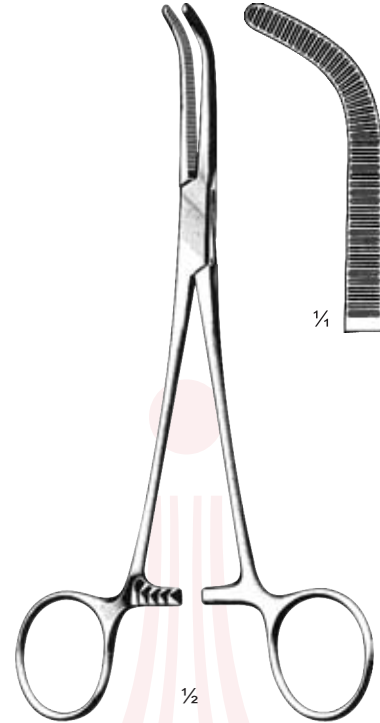

Mixer-O'Shaugnessy
DC05-201-19
19cm/7 1/2"

1/2

1/4

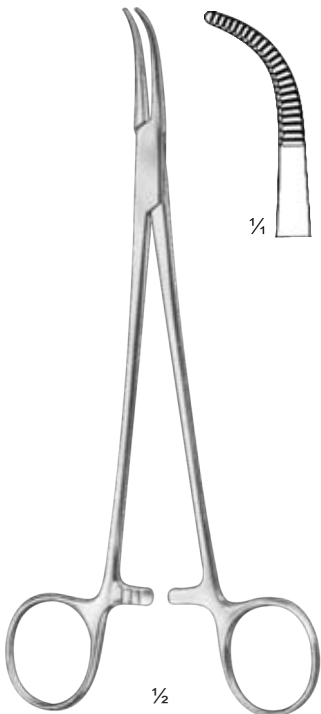

Baby-Mixer
DC05-203-18
18cm/7"



1/4

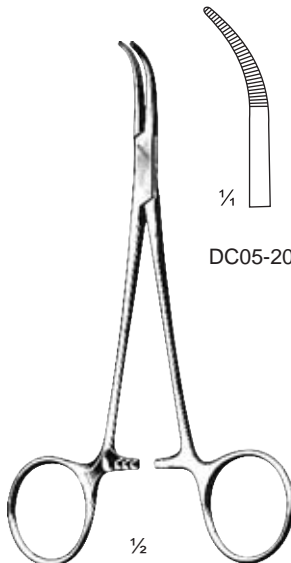

Baby-Mixer
14cm/5 1/2"



DC05-205-01

1/4



DC05-205-02

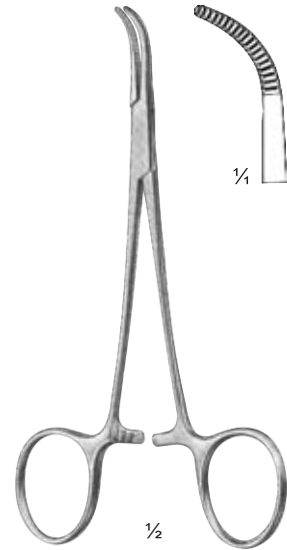

Baby-Mixer
DC05-207-14
14cm/5 1/2"

1/4

Dissecting, Hemostatic and Ligature Forceps

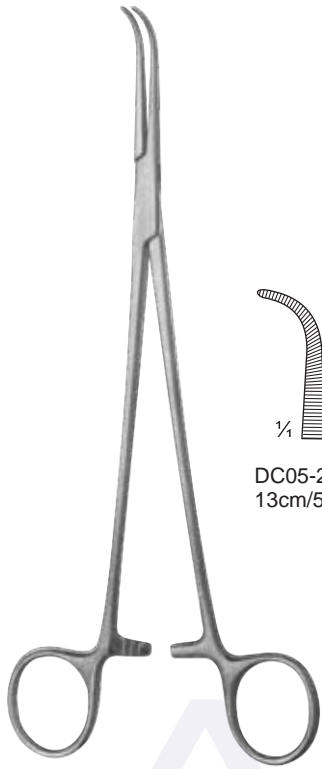
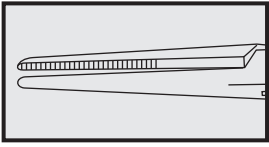

Gemini (DeBakey-Mixer)

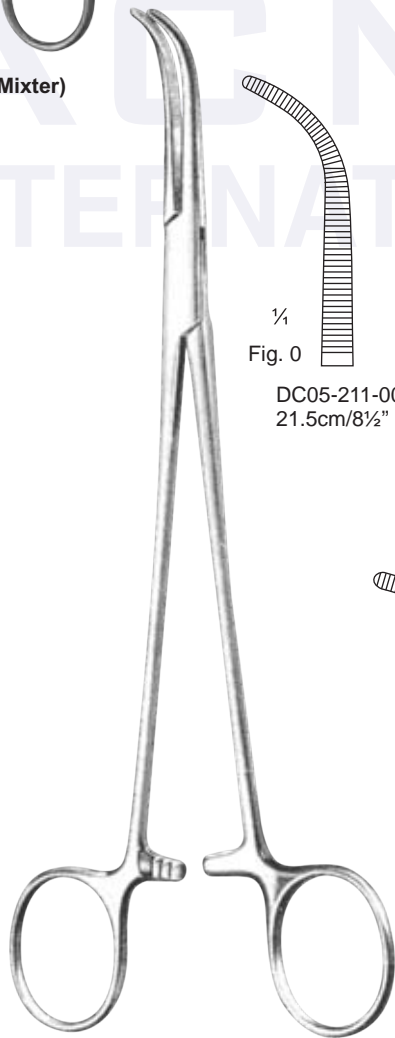
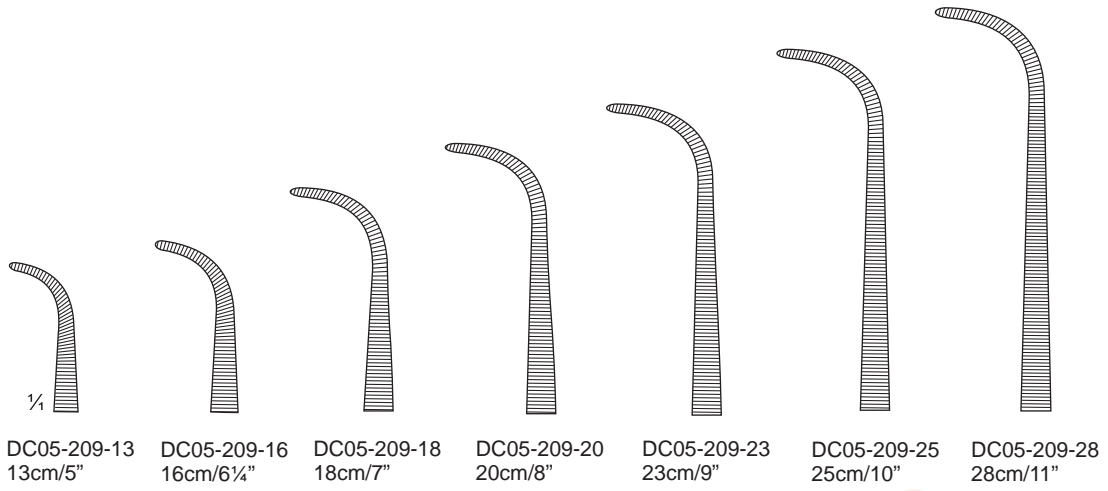

Overholt
delicate pattern

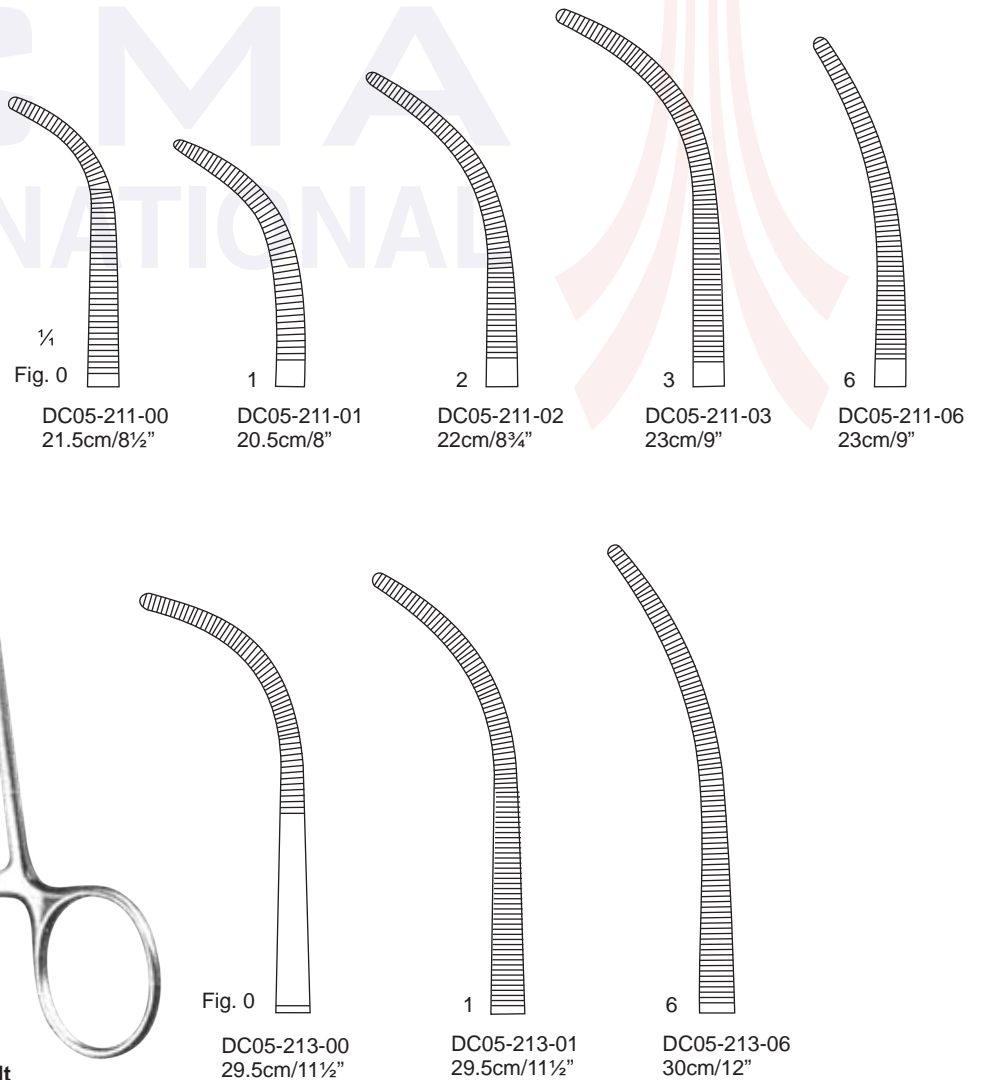

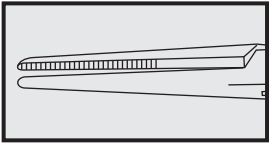

Dissecting, Hemostatic and Ligature Forceps



Overholt-Geissendoerfer
DC05-215-00



Overholt-Geissendoerfer
DC05-217-00

Fig. 0	1	2	3	4	5	6
DC05-215-00 19.5cm/7½"	DC05-215-01 21cm/8¼"	DC05-215-02 22.5cm/8¾"	DC05-215-03 22.5cm/9"	DC05-215-04 21.5cm/8¼"	DC05-215-05 22.5cm/9"	DC05-215-06 22.5cm/9"
DC05-217-00 26cm/10¼"	DC05-217-01 27cm/10½"	DC05-217-02 27.5cm/10¾"	DC05-217-03 27.5cm/10¾"	DC05-217-04 27.5cm/10¾"	DC05-217-05 28cm/11"	DC05-217-06 27.5cm/10¾"

Clamp-Forceps, Hysterectomy and Vaginal Forceps

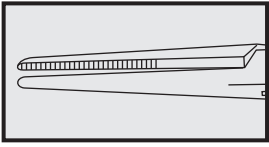

Dissecting, Hemostatic and Ligature Forceps

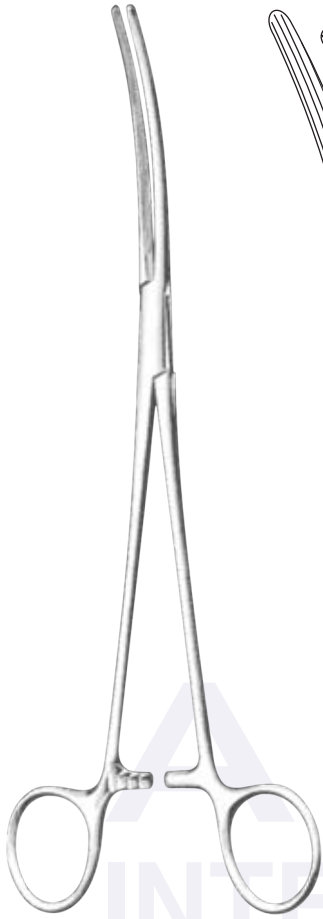

Crafoord-Sellors
24cm/9½"

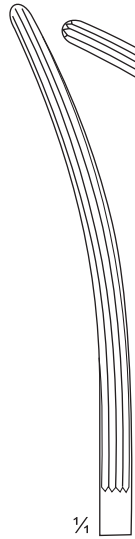

Fig. 1
DC05-219-24

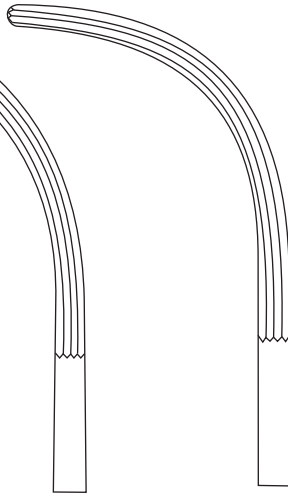
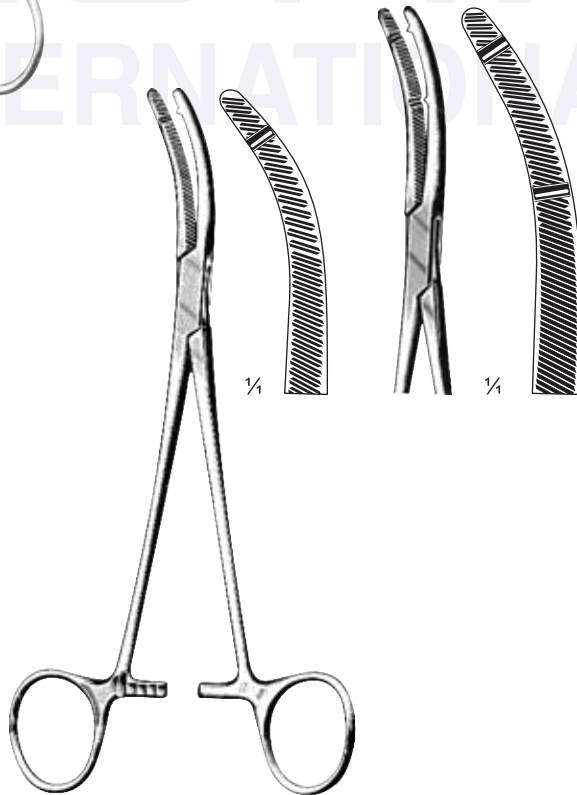

Fig. 2
DC05-219-23



Fig. 3
DC05-219-22



Heaney	cm	in.	
DC05-221-19	19.5	7 ¾	DC05-223-19
DC05-221-21	21.0	8 ¼	DC05-223-21
DC05-221-23	23.0	9	DC05-223-23

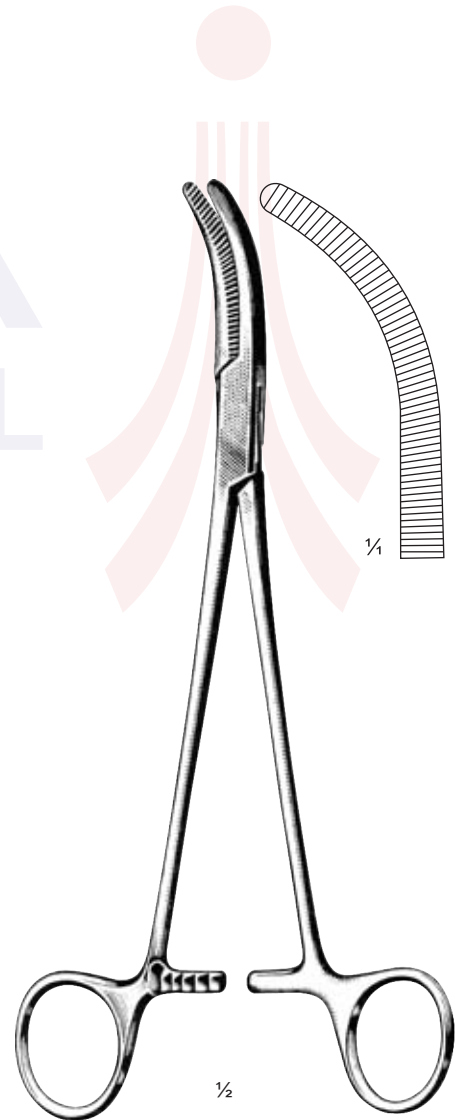

Wertheim
DC05-225-25
25 cm/10"

Clamp-Forceps, Hysterectomy and Vaginal Forceps

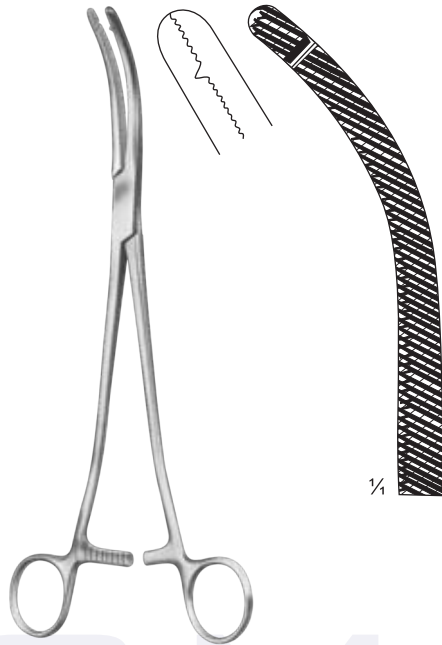
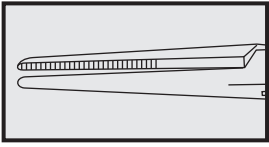

Wiener Modell
 DC05-227-20 = 20cm/8"
 DC05-227-22 = 22cm/8¾"
 DC05-227-25 = 25cm/10"

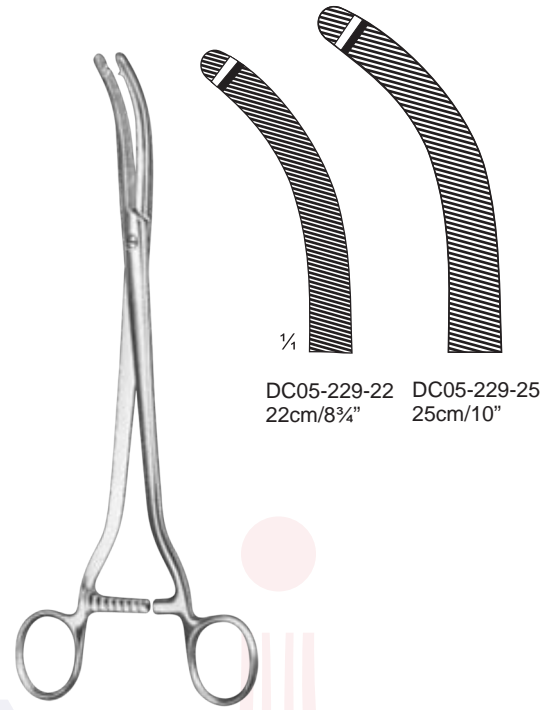

DC05-229-22 22cm/8¾"
 DC05-229-25 25cm/10"

Wiener Modell (Walzl)

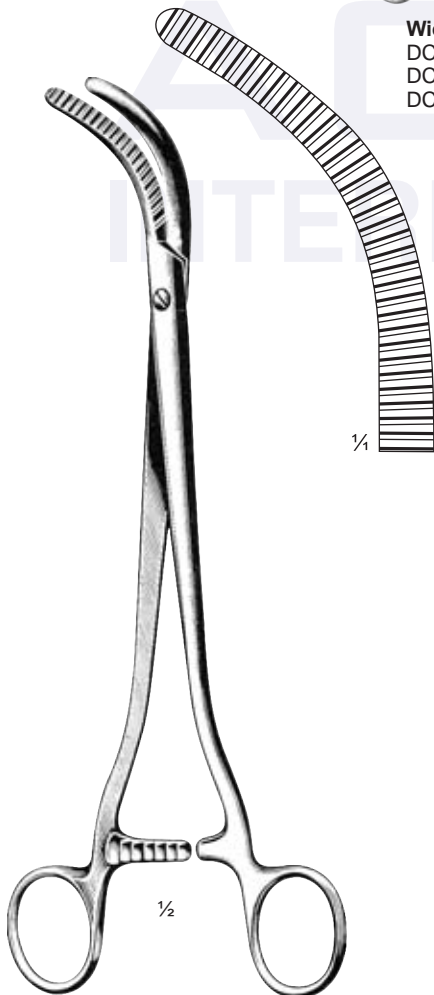

Wertheim
 DC05-231-25
 25 cm/10"

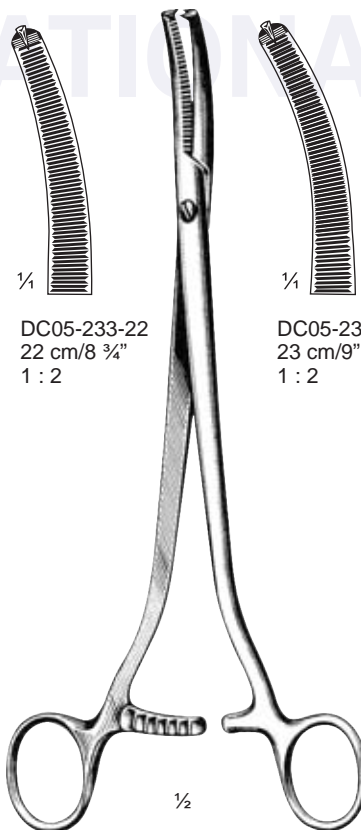

Wertheim
 DC05-233-22 slightly curved
 DC05-235-23 more curved

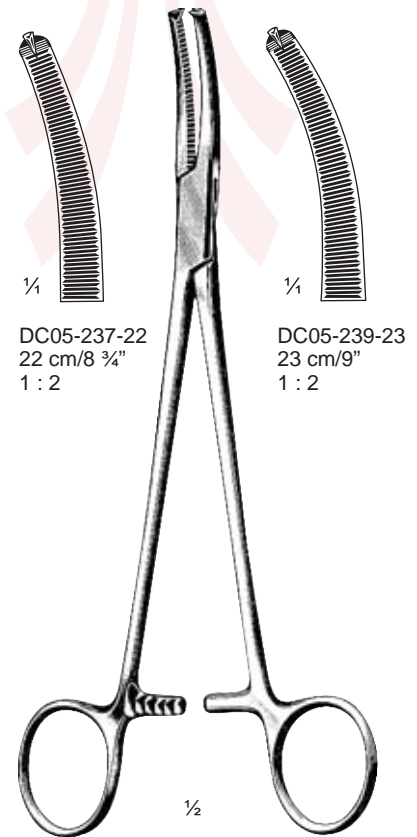

Wertheim
 DC05-237-22 slightly curved
 DC05-239-23 more curved

Clamp-Forceps, Hysterectomy and Vaginal Forceps

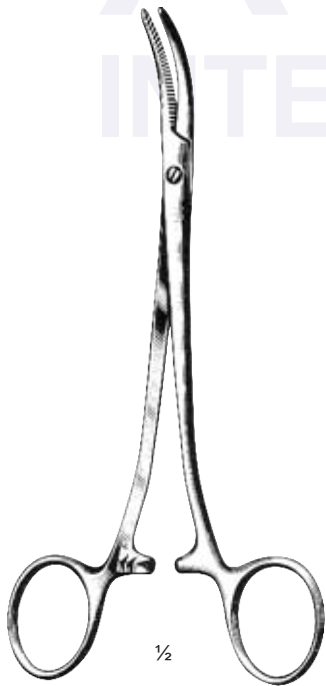
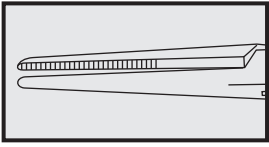

Wertheim
DC05-239-18
18 cm/7"



Phaneuf
21.5cm/8½"

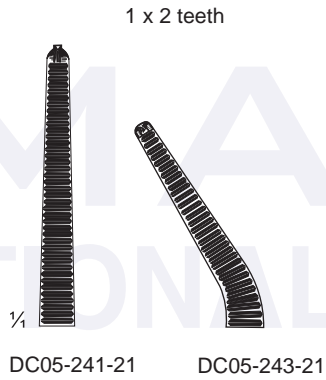

DC05-241-21

DC05-243-21

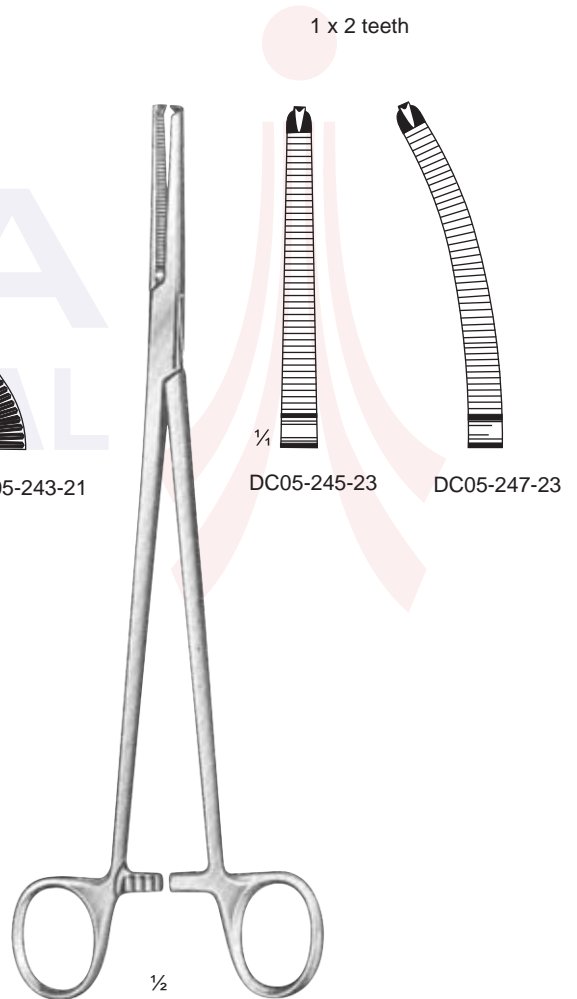

Holzbach
23.5cm/9¼"

Clamp-Forceps, Hysterectomy and Vaginal Forceps

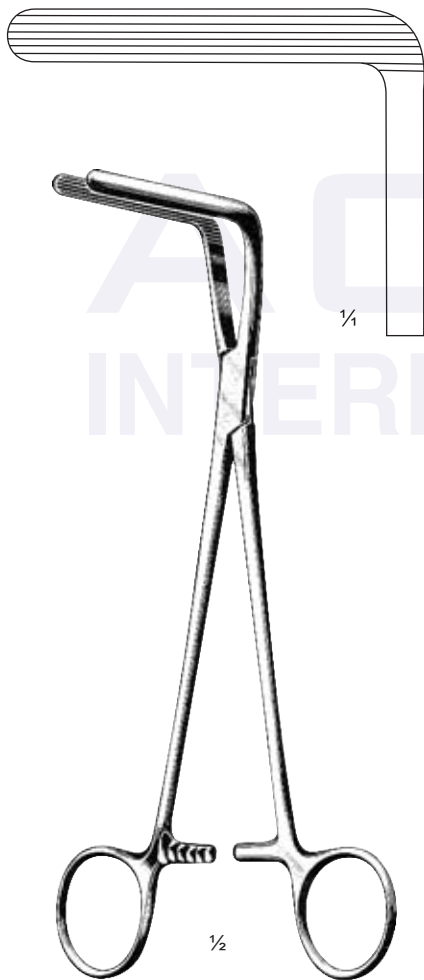
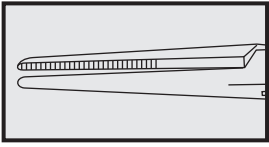

Wertheim-Cullen
DC05-249-21
21.5 cm/8 1/2"



Wertheim
DC05-251-24
24 cm/9 1/2"

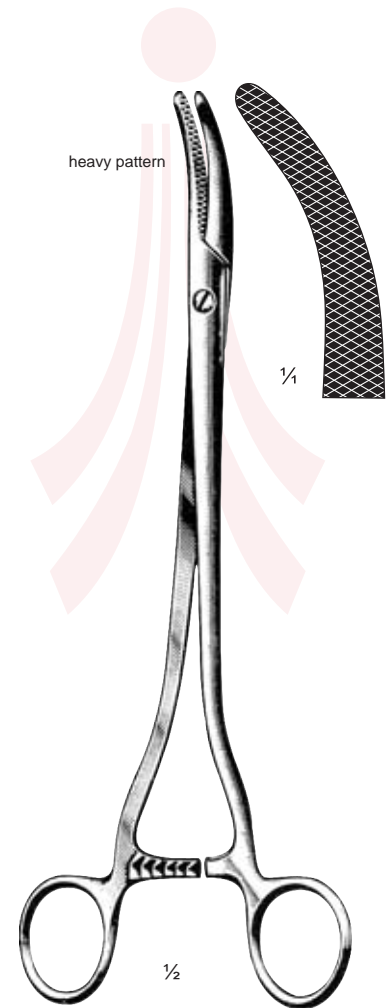

Wertheim
DC05-253-25
25 cm/10"

Clamp-Forceps, Hysterectomy and Vaginal Forceps

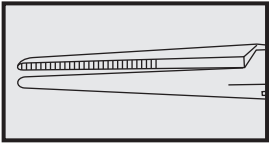

Wertheim-Martin
23 cm/9 1/4"

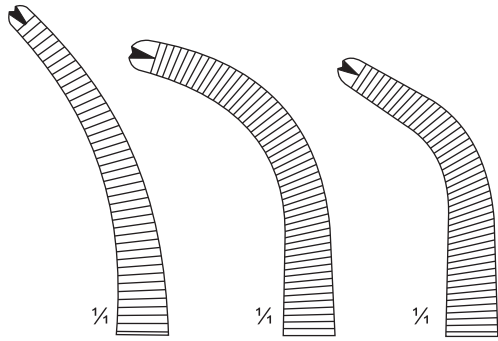

DC05-255-23 DC05-257-23 DC05-259-23

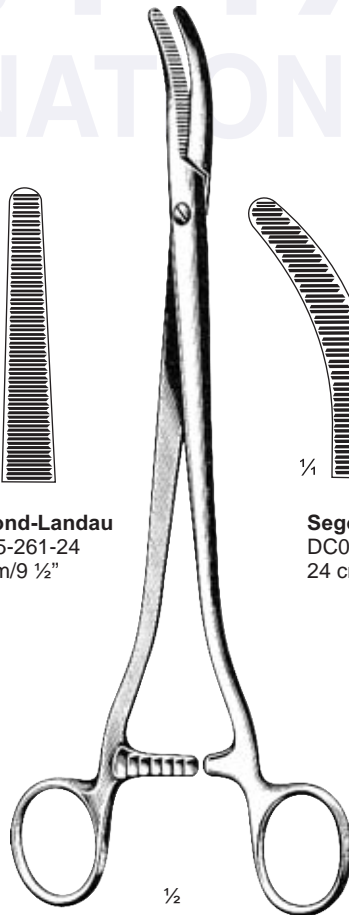

Segond-Landau
DC05-261-24
24 cm/9 1/2"

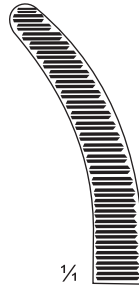

Segond
DC05-263-24
24 cm/9 1/2"

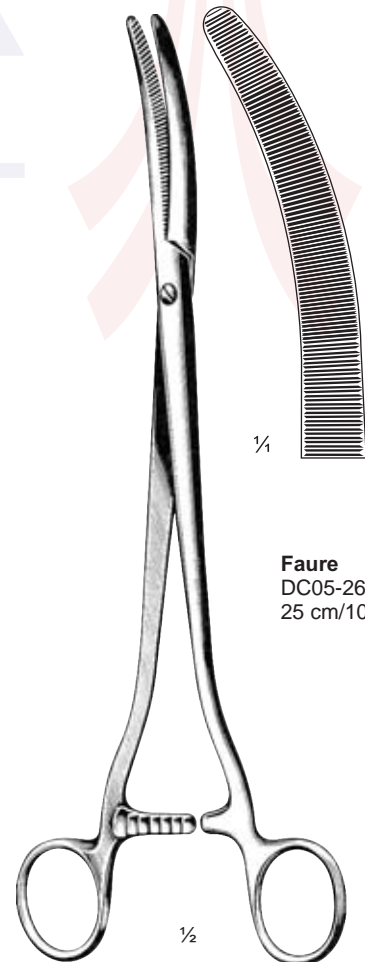

Faure
DC05-265-25
25 cm/10"

Clamp-Forceps, Hysterectomy and Vaginal Forceps

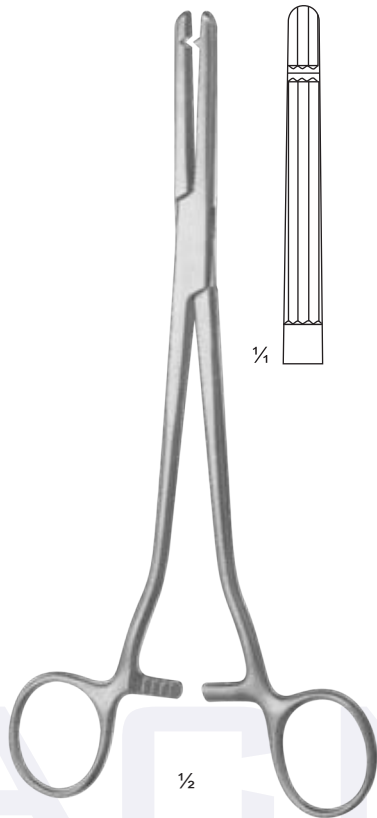
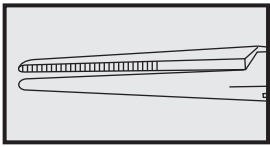

Ballentine
DC05-267-21
21.5cm/8½"

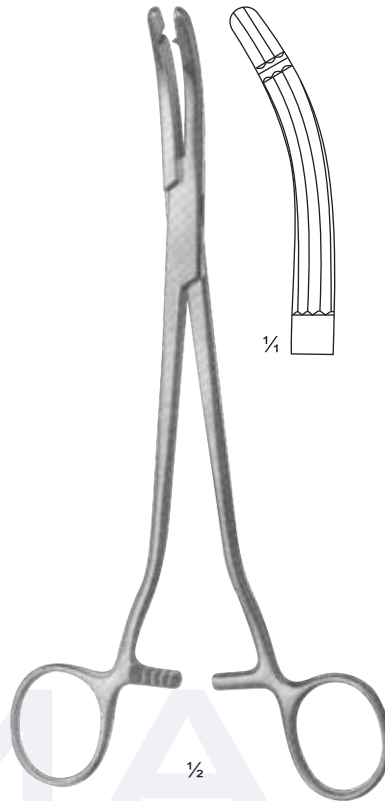

Heaney-Ballentine
DC05-269-21
21.5cm/8½"

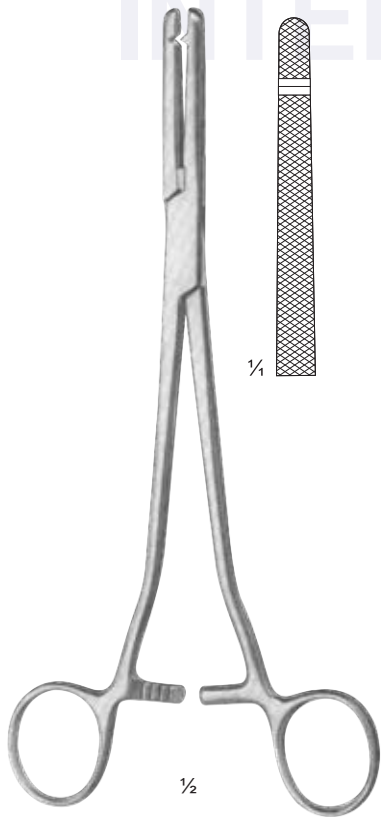

Heaney-Rezek
DC05-271-21
21.5cm/8½"

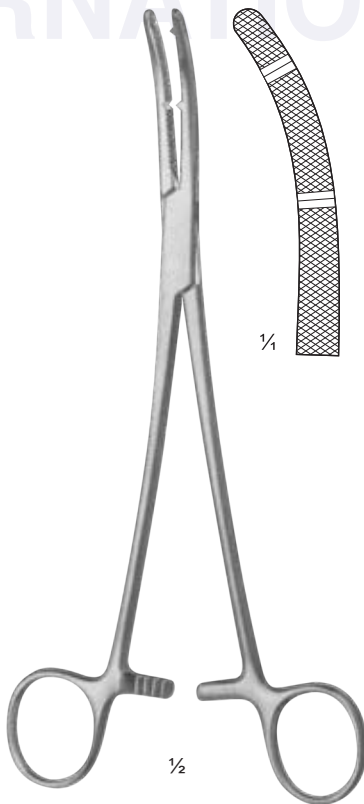

Heaney-Kanter
DC05-273-21
21.5cm/8½"

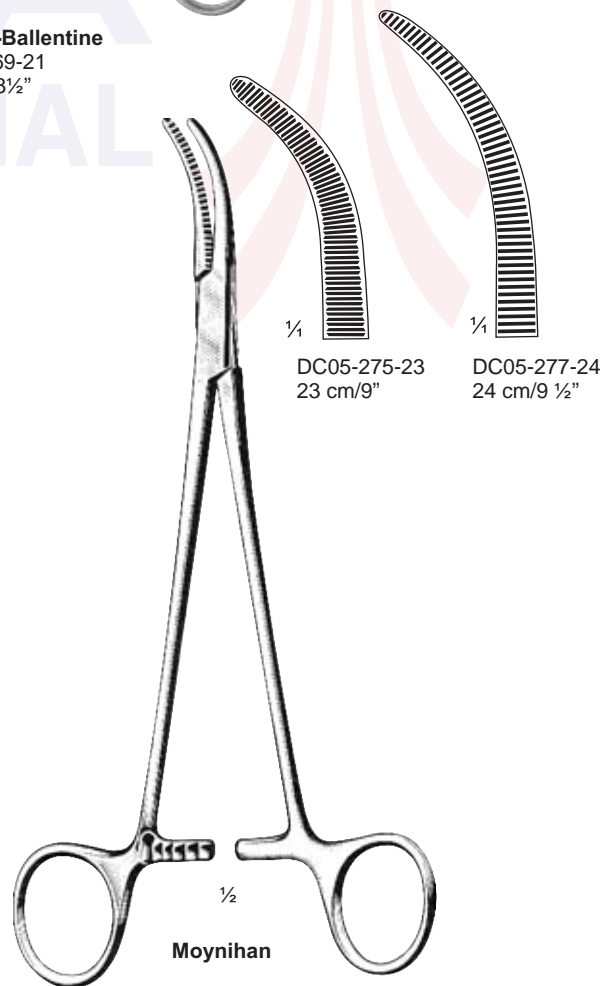

DC05-275-23
23 cm/9"

DC05-277-24
24 cm/9 ½"

Moynihan

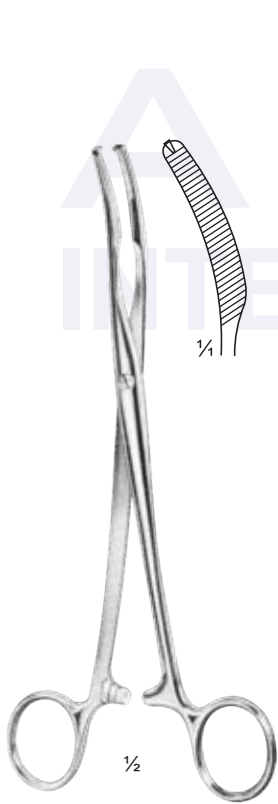
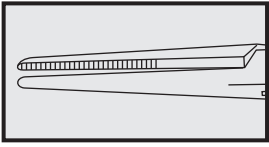

Mikulicz
DC05-279-18
18 cm/7"
1 : 2

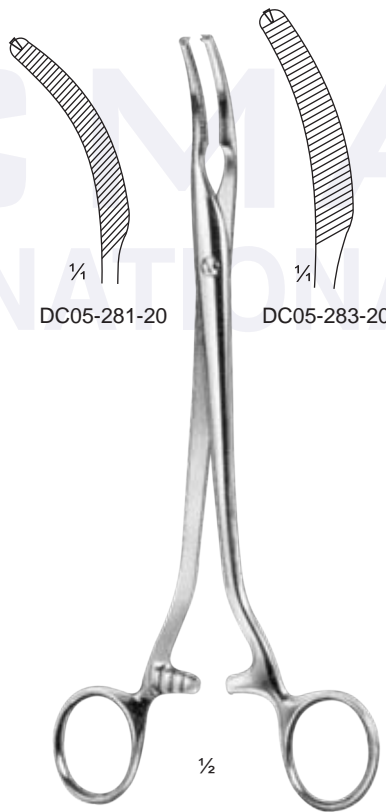

Mikulicz
20 cm/8"
1 : 2

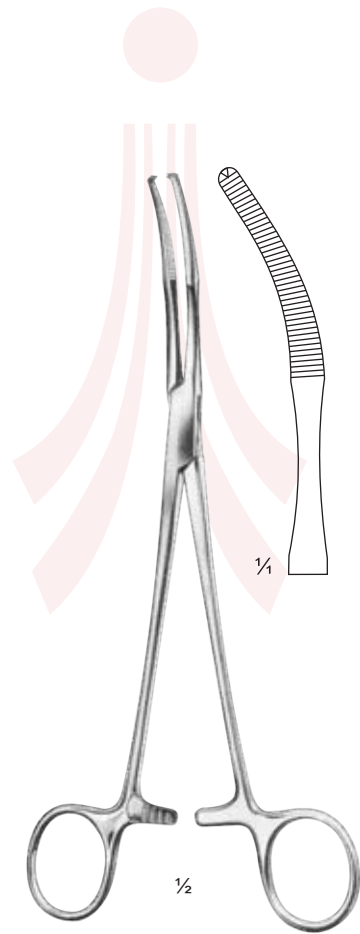

Mikulicz
DC05-285-20
20 cm/8"
1 : 2

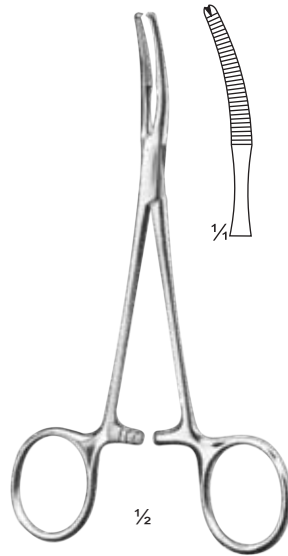
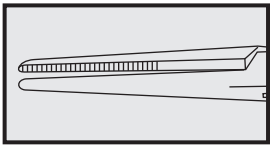

Baby-Mikulicz
DC05-287-14
14 cm/5 1/2"

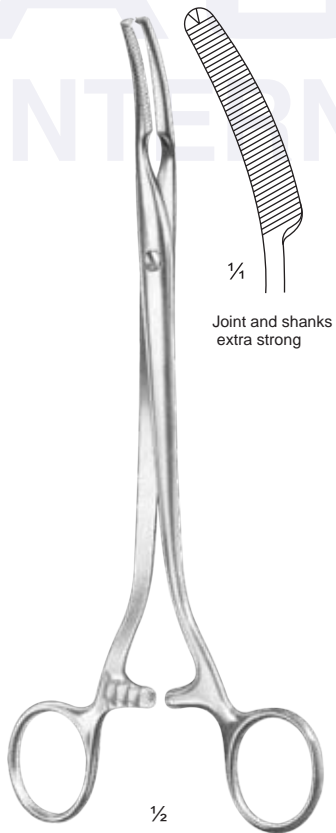

Joint and shanks
extra strong

Mikulicz
DC05-289-21
20.0 cm/8"

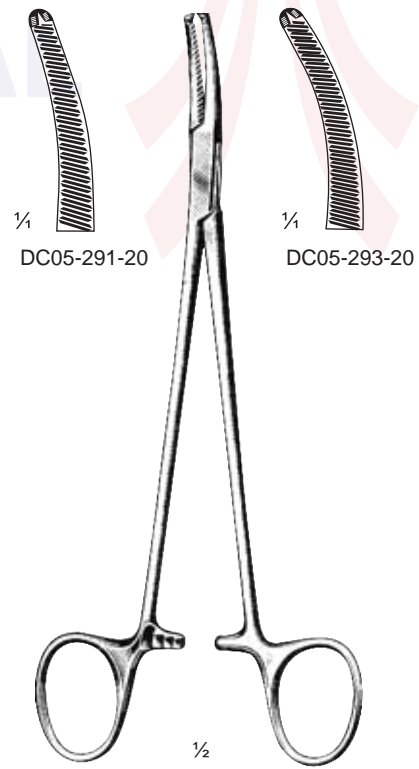

Faure
20 cm/8"
1 : 2

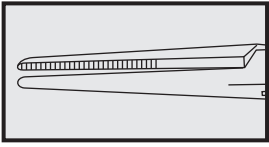

Forceps: Polypus, Tumor, Swab

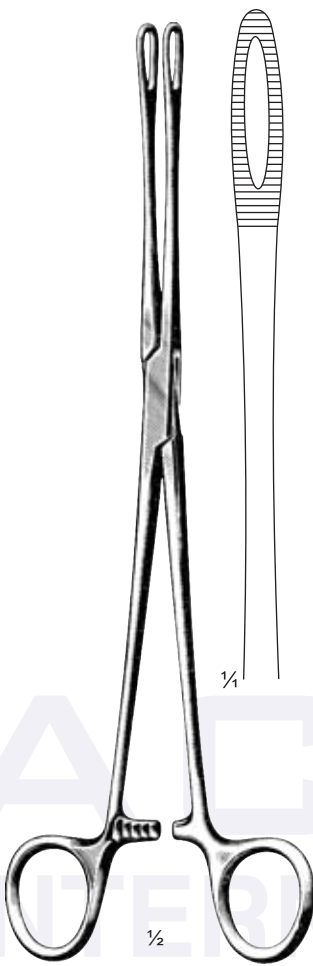

Foerster
25 cm/10"
narrow

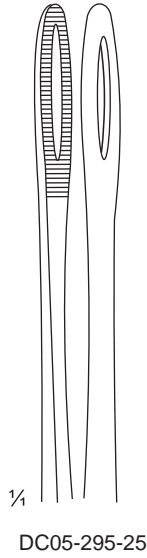

1/4
DC05-295-25

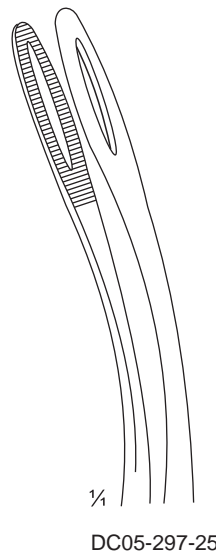

1/4
DC05-297-25



Ramley
DC05-299-25
25 cm/10"

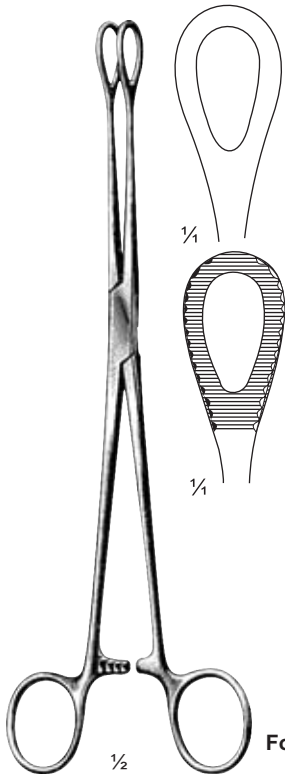

Foerster

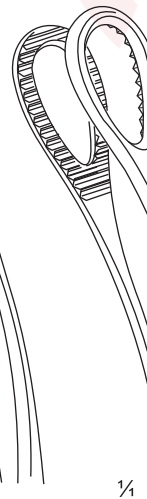
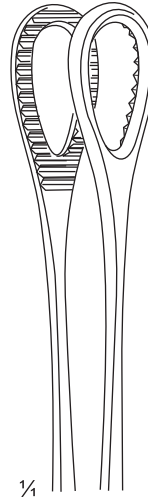
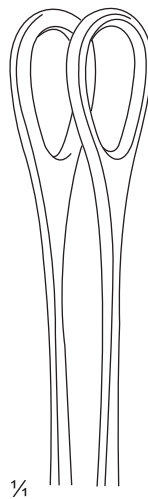

cm	in.		
18.0	7	DC05-303-18	DC05-307-18
20.0	8	DC05-303-20	DC05-307-20
25.0	10	DC05-301-25	DC05-303-25
			DC05-305-25
			DC05-307-25

Dressing Forceps, Polyps Forceps, Foreign Body Forceps

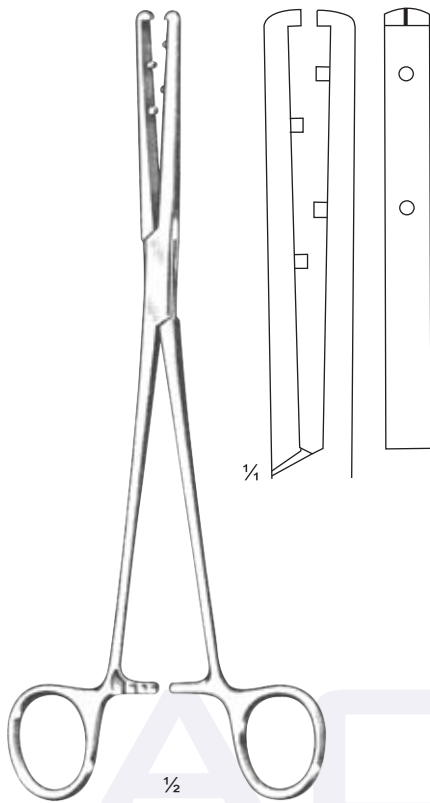
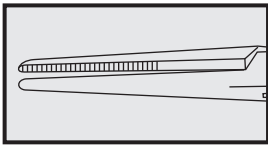

Emmet
DC05-309-21
21cm/8 1/4"

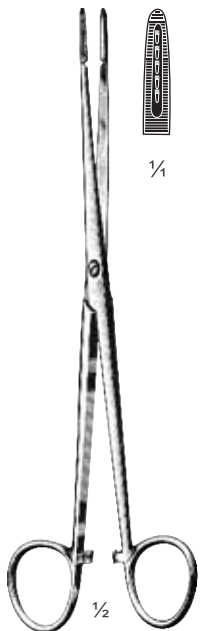

Mod. Martin
DC05-311-17
17 cm/6 3/4"



DC05-313-17

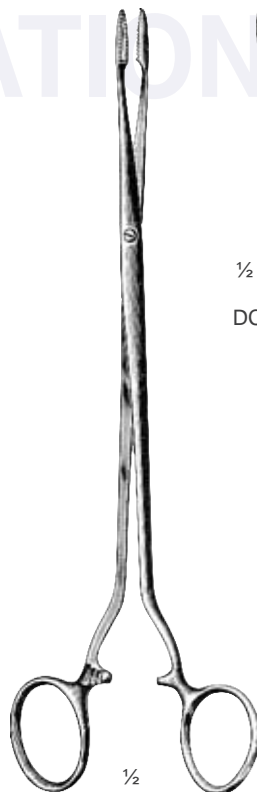

Duplay
DC05-315-20
20 cm/8"



DC05-317-20

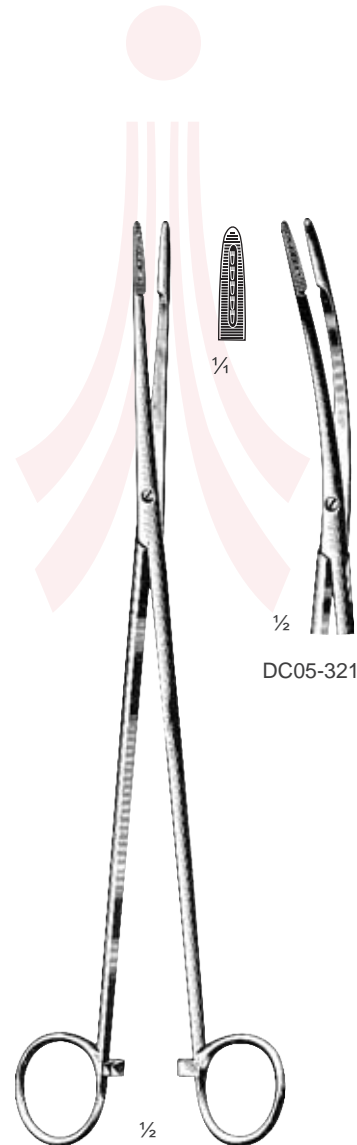

Mod. Martin
DC05-319-25
25.5 cm/10"

DC05-321-25

Cotton Swab Forceps, Polypus and Dressing Forceps

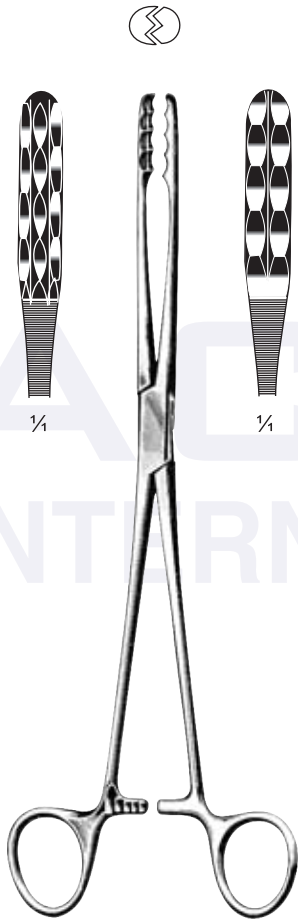
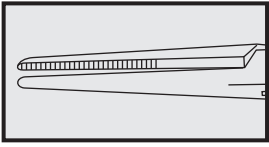

Ulrich
DC05-323-22 = 22 cm/8 3/4"
DC05-323-25 = 25 cm/10"
DC05-323-27 = 27 cm/10 3/4"

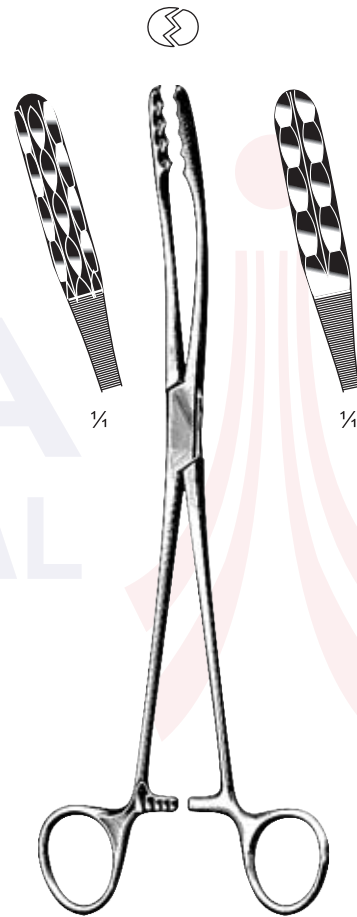

Ulrich
DC05-325-22 = 22 cm/8 3/4"
DC05-325-25 = 25 cm/10"
DC05-325-27 = 27 cm/10 3/4"

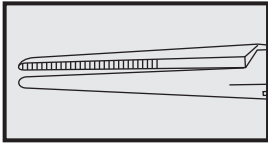

Polypus and Dressing Forceps, Cotton Swab Forceps

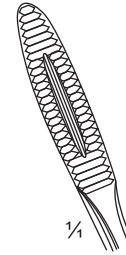
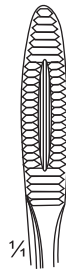

straight	cm	in.	curved
DC05-327-20	20	8	DC05-329-20
DC05-327-22	22	8 ¾	DC05-329-22
DC05-327-25	25	10	DC05-329-25

Gross-Maier
20 cm/8"

ACMA
INTERNATIONAL

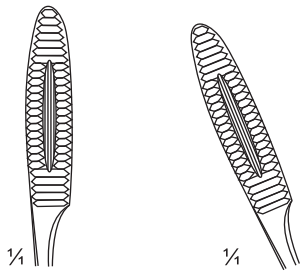
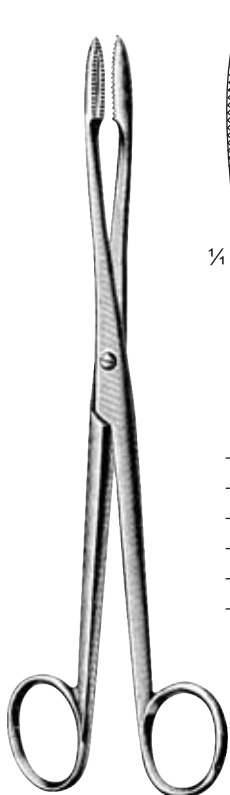

without ratchet

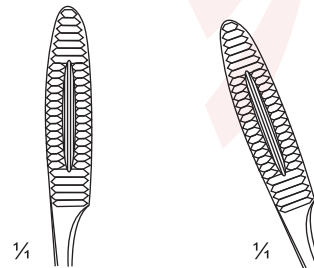

with ratchet

straight	curved	cm	in.	straight	curved
-	-	14.5	5 ½	DC05-335-14	DC05-337-14
DC05-331-16	DC05-333-16	16	6 ¼	DC05-335-16	DC05-337-16
DC05-331-18	DC05-333-18	18	7	DC05-335-18	DC05-337-18
DC05-331-20	DC05-333-20	20	8	DC05-335-20	DC05-337-20
DC05-331-25	DC05-333-25	25	10	DC05-335-25	DC05-337-25

Gross-Maier

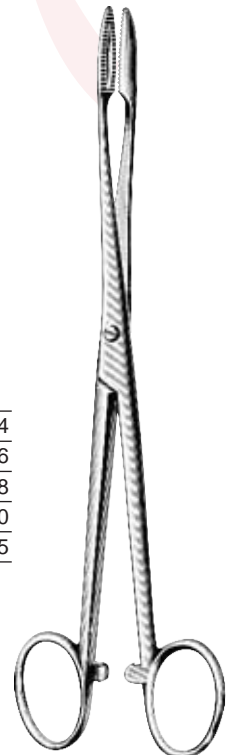

Gross-Maier

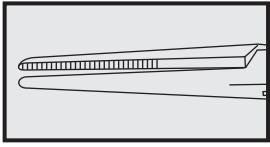

Polypus, Dressing and Cotton Swab Forceps, Foreign Body Forceps

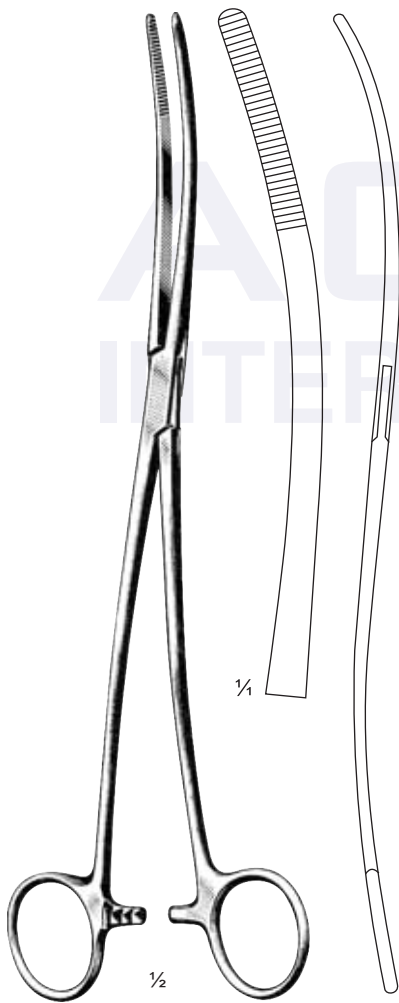

Bozemann
DC05-339-26
26 cm/10 1/4"

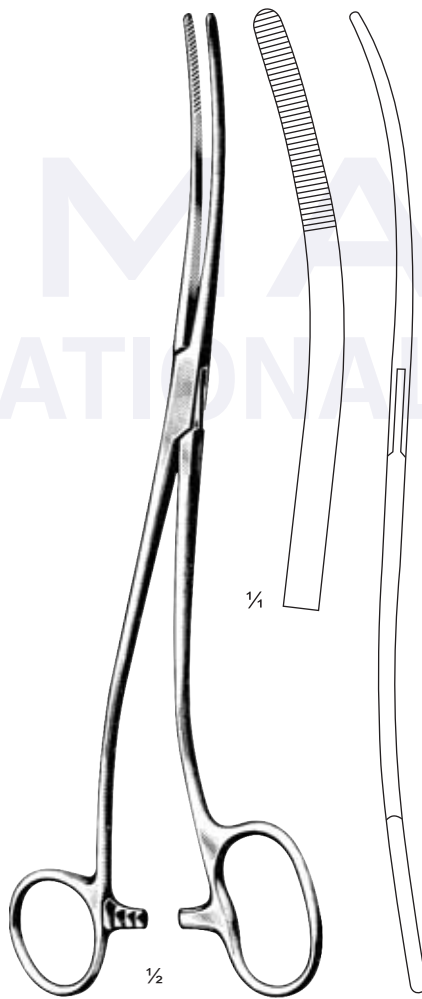

Bozemann-Douglas
DC05-341-26
26 cm/10 1/4"

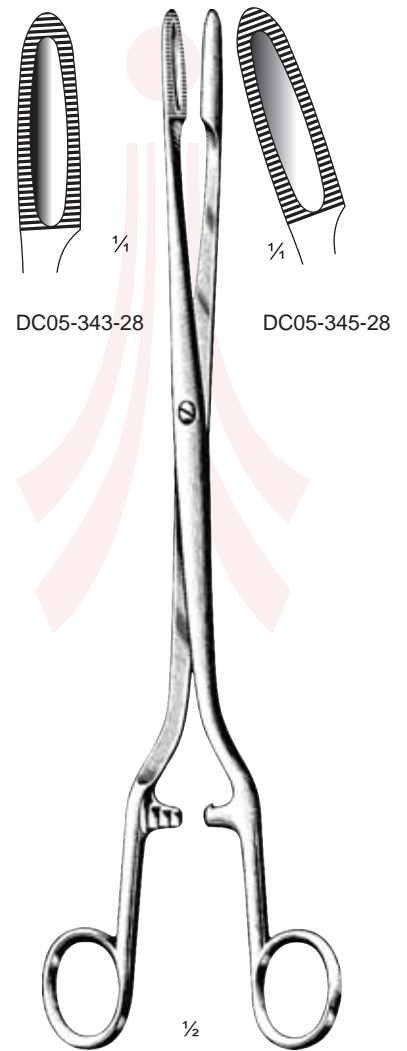

Sims-Maier
28 cm/11"

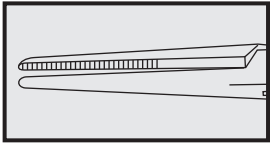

Polypus, Dressing and Cotton Swab Forceps, Foreign Body Forceps

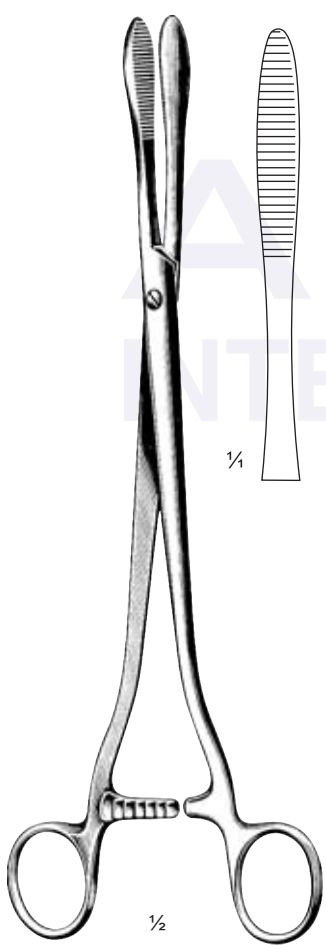

Collin
DC05-347-25
25 cm/10"



Pelkman
DC05-349-25
25 cm/10"



Maier
DC05-353-25
25 cm/10"

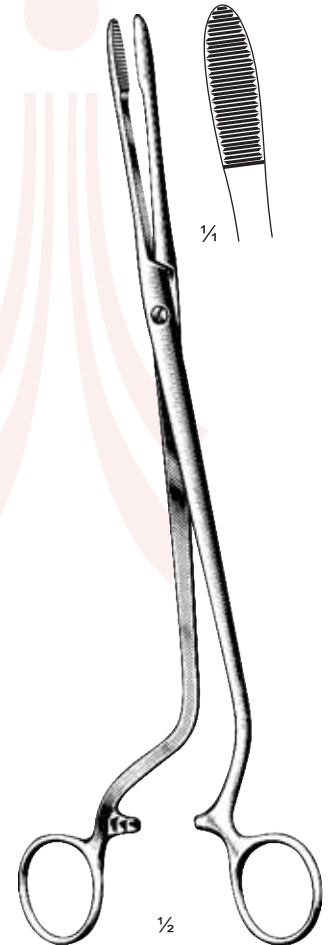

Cheron
DC05-355-25
25 cm/10"

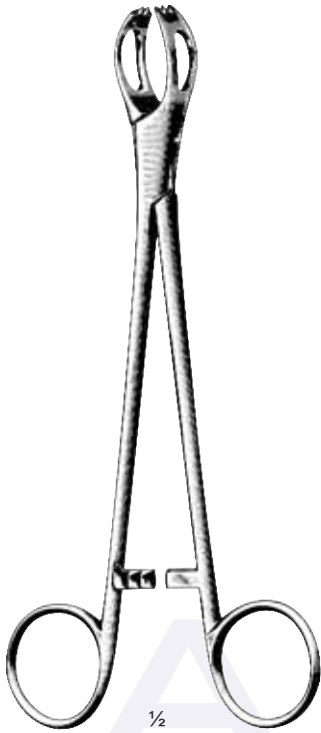
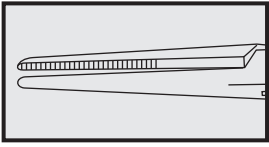

Lane
DC05-357-20
20 cm/8"



Roeder
DC05-359-13 = 13 cm/5"
DC05-359-15 = 15 cm/6"

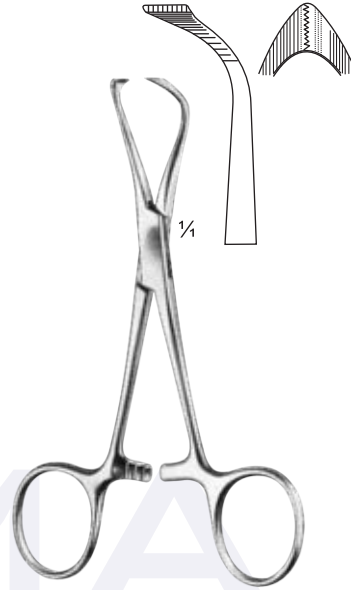

Lorna
DC05-361-10 = 10 cm/4"
DC05-361-13 = 13 cm/5"



Bernhard
DC05-363-16
16 cm/6 1/2"



DC05-365-11 = 11 cm/4 1/2"
DC05-365-13 = 13 cm/5"
delicate pattern



DC05-367-11
11 cm/4 1/2"
with Clip for Tubing or Cable

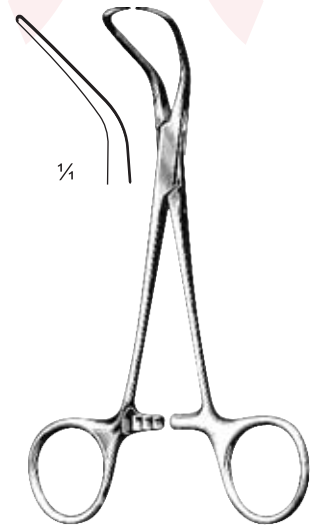

Backhaus
DC05-369-08 = 8 cm/3 1/4"
DC05-369-11 = 11 cm/4 1/2"
DC05-369-13 = 13 cm/5"
DC05-369-15 = 15 cm/6"

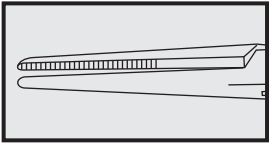

Towel Forceps

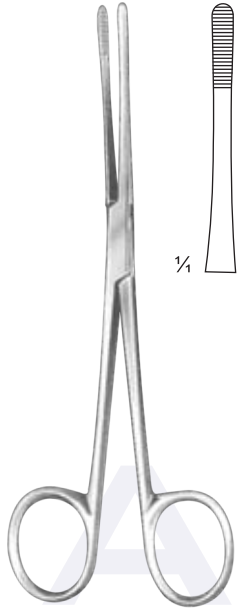

Lister
 DC05-371-13 = 13cm/5"
 DC05-371-15 = 15cm/6"
 DC05-371-18 = 18cm/7"

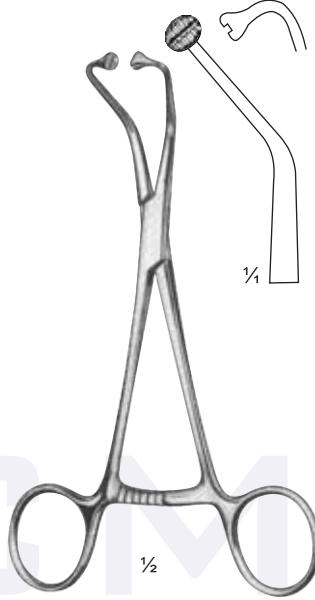

Peers
 DC05-373-14
 14.5cm/ 5 3/4"

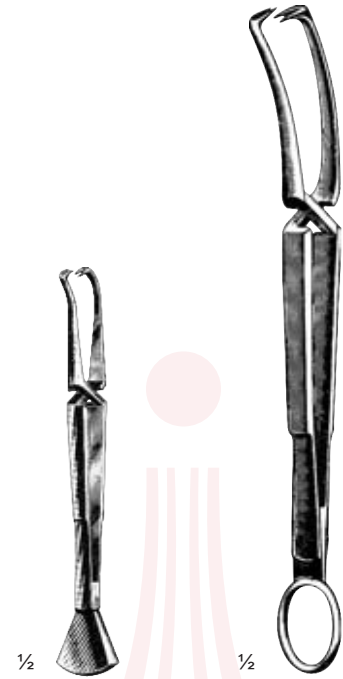

Doyen
 DC05-375-11
 11 cm/4 1/2"

Doyen
 DC05-377-18
 18 cm/7"



Schaedel
 DC05-379-09
 9 cm/3 1/2"



Engl. Modell
 DC05-381-09
 9 cm/3 1/2"



Jones
 DC05-383-05 = 5 cm/2"
 DC05-383-09 = 9 cm/3 1/2"



Jones-Martin
 DC05-385-09
 9 cm/3 1/2"
 with Clip for
 Tubing or Cable

Various Forceps

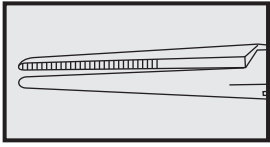

Tendon Interlacing Forceps

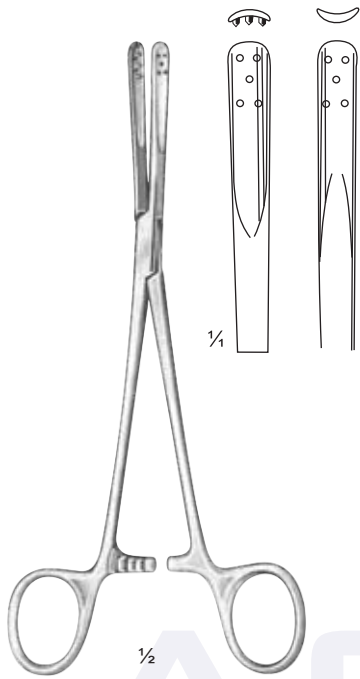

Brand
DC05-387-15
15.5cm/5 3/4"

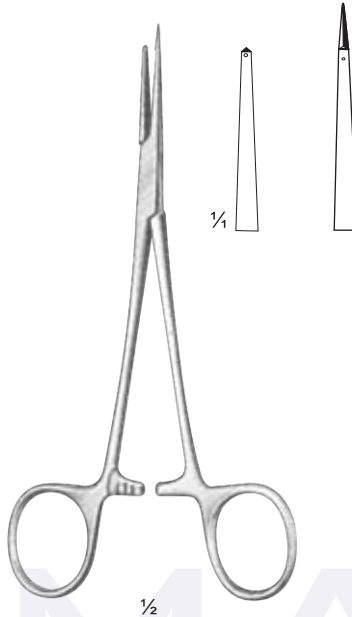

DC05-389-15
15cm/6"

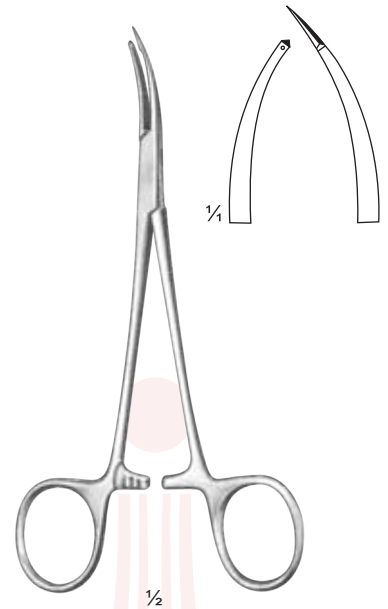

DC05-391-15
15cm/6"

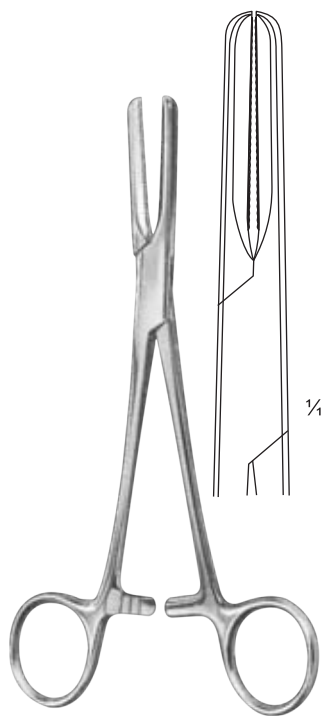

DC05-393-15
15cm/6"

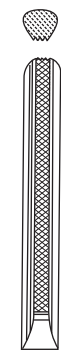

DC05-393-18
18cm/7"

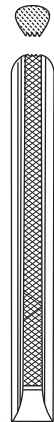

DC05-393-20
20cm/8"

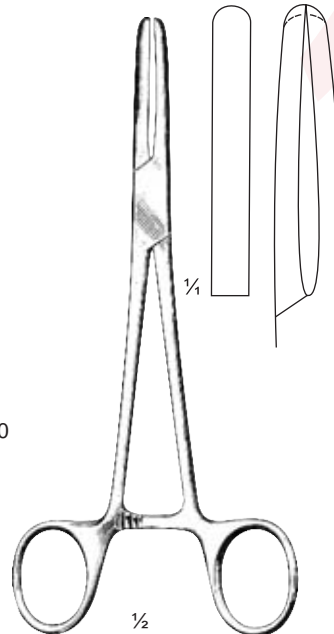

Presbyterian-Hospital
DC05-395-16
16.5cm/6 1/2"

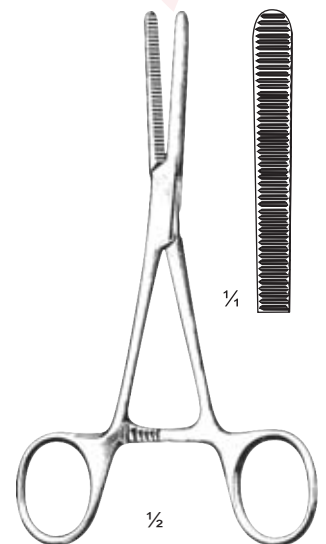

Mod. Klinikum Berlin
DC05-397-14
14.5cm/5 3/4"

ACMA
INTERNATIONAL

