

9

Gynecology

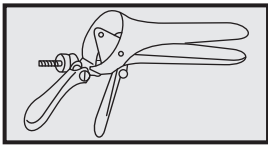



Scheme of dimension for specula

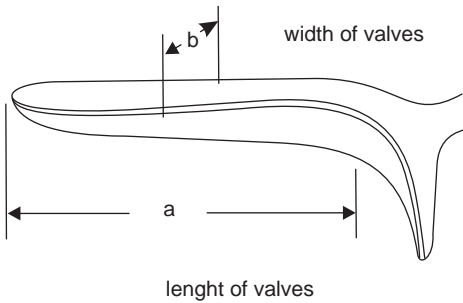

for c hildren

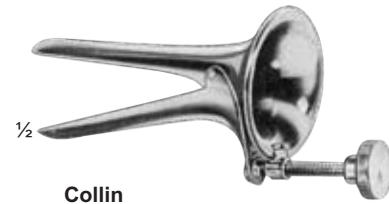

Collin
DC09-001-01
55 x 10 mm



Cusco

a mm	b mm	
75	32	DC09-003-01
85	35	DC09-003-02
100	35	DC09-003-03



Cusco

a mm	b mm	
75	17	DC09-005-01

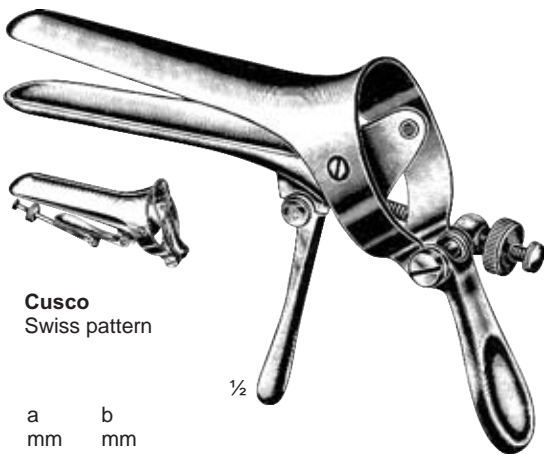

Cusco
Swiss pattern

a mm	b mm	
80	22	DC09-007-01
100	25	DC09-007-02
105	27	DC09-007-03

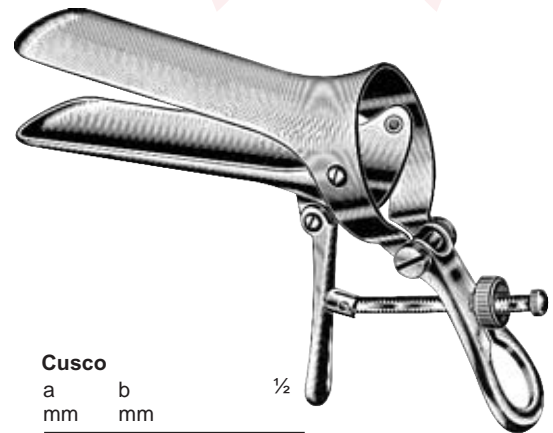

Cusco

a mm	b mm	
75	32	DC09-009-01
85	35	DC09-009-02
100	37	DC09-009-03

- DC09-003-01 - Vaginal Specula, with lateral ratchet, with folding handles
- DC09-005-01 - ditto, conical shape, virgin size
- DC09-007-01 - DC09-007-03 - Swiss pattern, narrow, with lateral ratchet, with folding handles
- DC09-009-01 - DC09-009-03 - with ratchet at the folding handles

Vaginal Specula

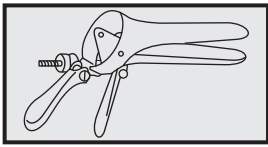

Collin

a mm	b mm	
65	20	DC09-011-01

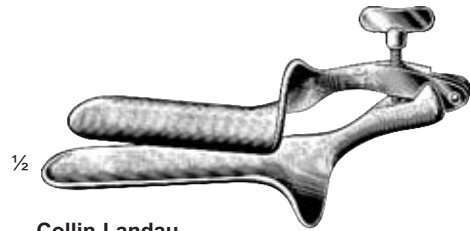

Collin-Landau

a mm	b mm	
100	35	DC09-015-02

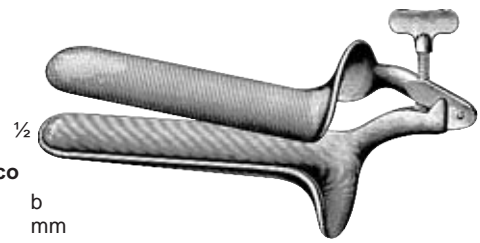

Cusco

a mm	b mm	
85	30	DC09-013-01
100	35	DC09-013-02
110	40	DC09-013-03

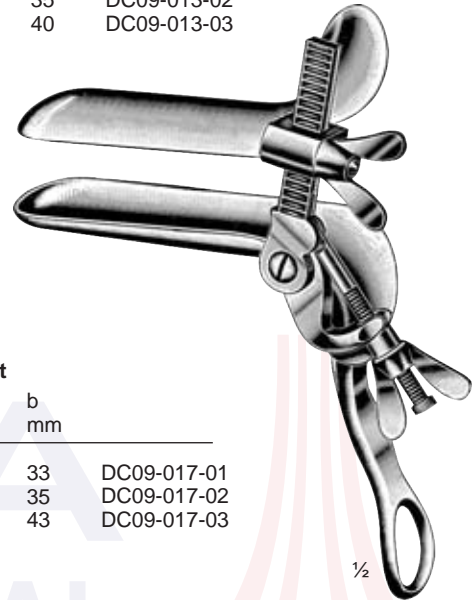

Trelat

a mm	b mm	
85	33	DC09-017-01
95	35	DC09-017-02
115	43	DC09-017-03



O'Sullivan- O'Connor
DC09-019-00

Fig.	a mm	b mm
1	45	17
2	90	37
3	90	45

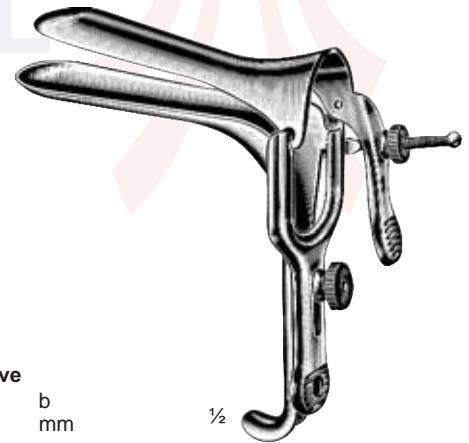

Grave

a mm	b mm	
75	20	DC09-021-01
95	35	DC09-021-02
115	35	DC09-021-03

- DC09-013-01 - DC09-013-03 - detachable
- DC09-015-01 - detachable, top blade shorter
- DC09-017-01 - DC09-017-03 - detachable, with folding handles
- DC09-019-00 - Vaginal Speculum, for examination and operative work, self-retaining, with adjustable frame, Loktite ratchet, 2 mobile lateral valves, and 3 interchangeable blades fig. 1-3
- DC09-021-01 - DC09-021-03 - with lateral ratchet, detachable, lower blade convertible into vaginal retractor

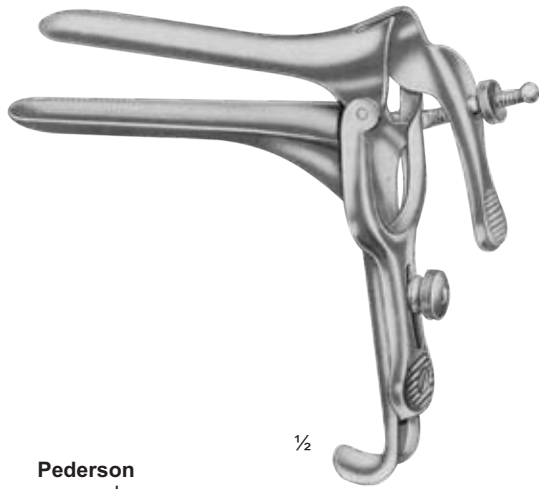
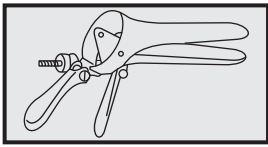

Pederson

a mm	b mm	
75	13	DC09-023-01
100	22	DC09-023-02
120	25	DC09-023-03



Semm

DC09-025-01	= 100 x 17/20 mm
DC09-025-02	= 100 x 25/30 mm

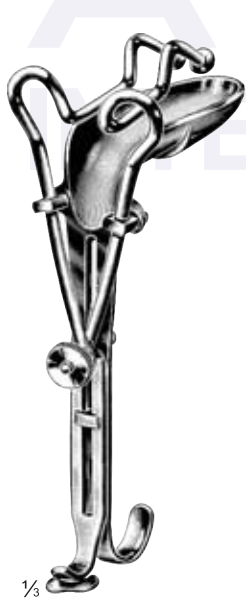

Guttmann

a mm	b mm	
90	35	DC09-027-01



Guttmann

a mm	b mm	
80	45	DC09-029-01

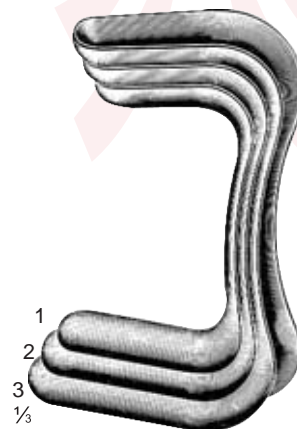

Sims

Fig	a mm	b mm	
1	60	25+30	DC09-031-01
2	70	30+35	DC09-031-02
3	80	35+40	DC09-031-03

DC09-025-01 - DC09-025-02 - for one handed use
 DC09-027-01 - ditto, examining pattern, self-retaining
 DC09-029-01 - ditto, operating pattern, self-retaining
 DC09-031-01 - DC09-031-03 - double, medium-concave

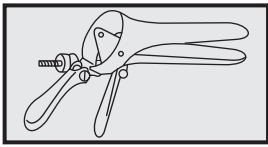

Vaginal Specula

Scheme of dimensions for specula

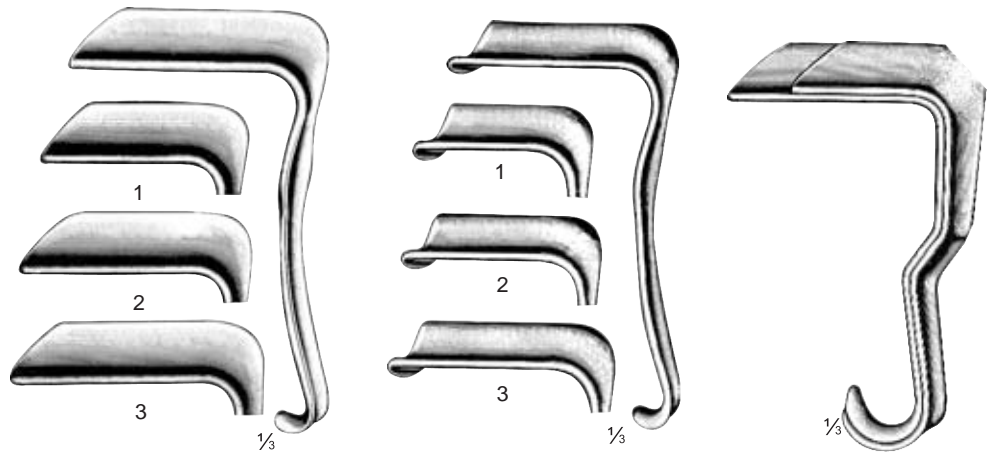
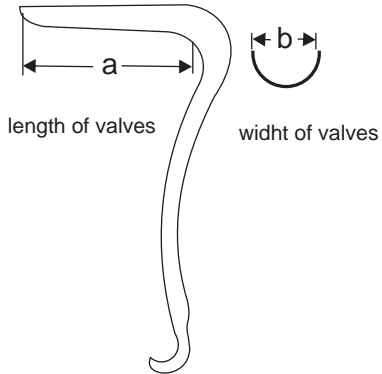

Jackson

b = 35 mm	b = 40 mm	Fig.	a mm
DC09-033-01	DC09-035-01	1	75
DC09-033-02	DC09-035-02	2	90
DC09-033-03	DC09-035-03	3	100

Eastman

b = 35 mm	b = 40 mm	Fig.	a mm
DC09-037-01	DC09-039-01	1	75
DC09-037-02	DC09-039-02	2	90
DC09-037-03	DC09-039-03	3	100

Auvard

a mm	b mm	Set
75	40	DC09-041-00
90	45	

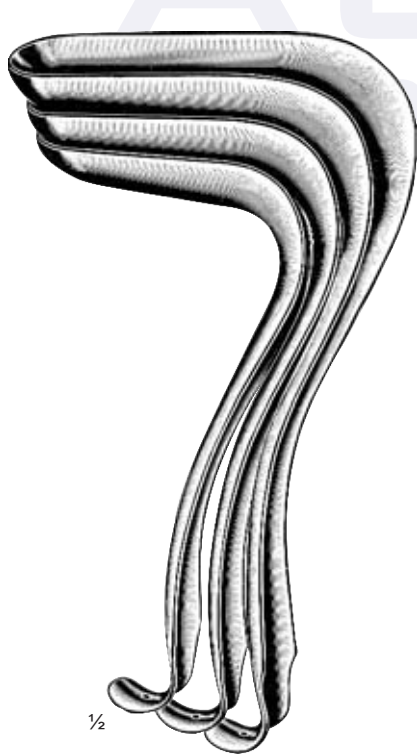

Kirsteller

Fig.	a mm	b mm	Specula
1	70	27	DC09-043-01
2	75	30	DC09-043-02
3	90	36	DC09-043-03



Kristeller

Fig.	a mm	b mm	Retractors
1	75	23	DC09-045-01
2	80	26	DC09-045-02
3	95	32	DC09-045-03



Kristeller

Fig.	Set of 1 Speculum and 1 Retractor each
1	DC09-047-01
2	DC09-047-02
3	DC09-047-03

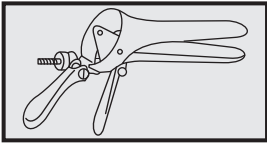

Kirsteller

Set of 1 Specula and 1 Retractor each

Fig. 00	DC09-049-01
0	DC09-049-02



Kirsteller

Fig.	a mm	b mm	Specula
00	110	18	DC09-051-01
0	110	21	DC09-051-02



Kirsteller

Fig.	a mm	b mm	Retractors
00	115	14	DC09-053-01
0	115	17	DC09-053-02

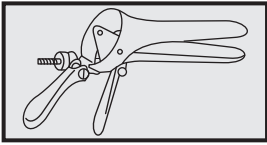

Kirsteller

Set of 1 Specula and 1 Retractor each

Fig. 1	DC09-055-01
Fig. 2	DC09-055-02
Fig. 3	DC09-055-03

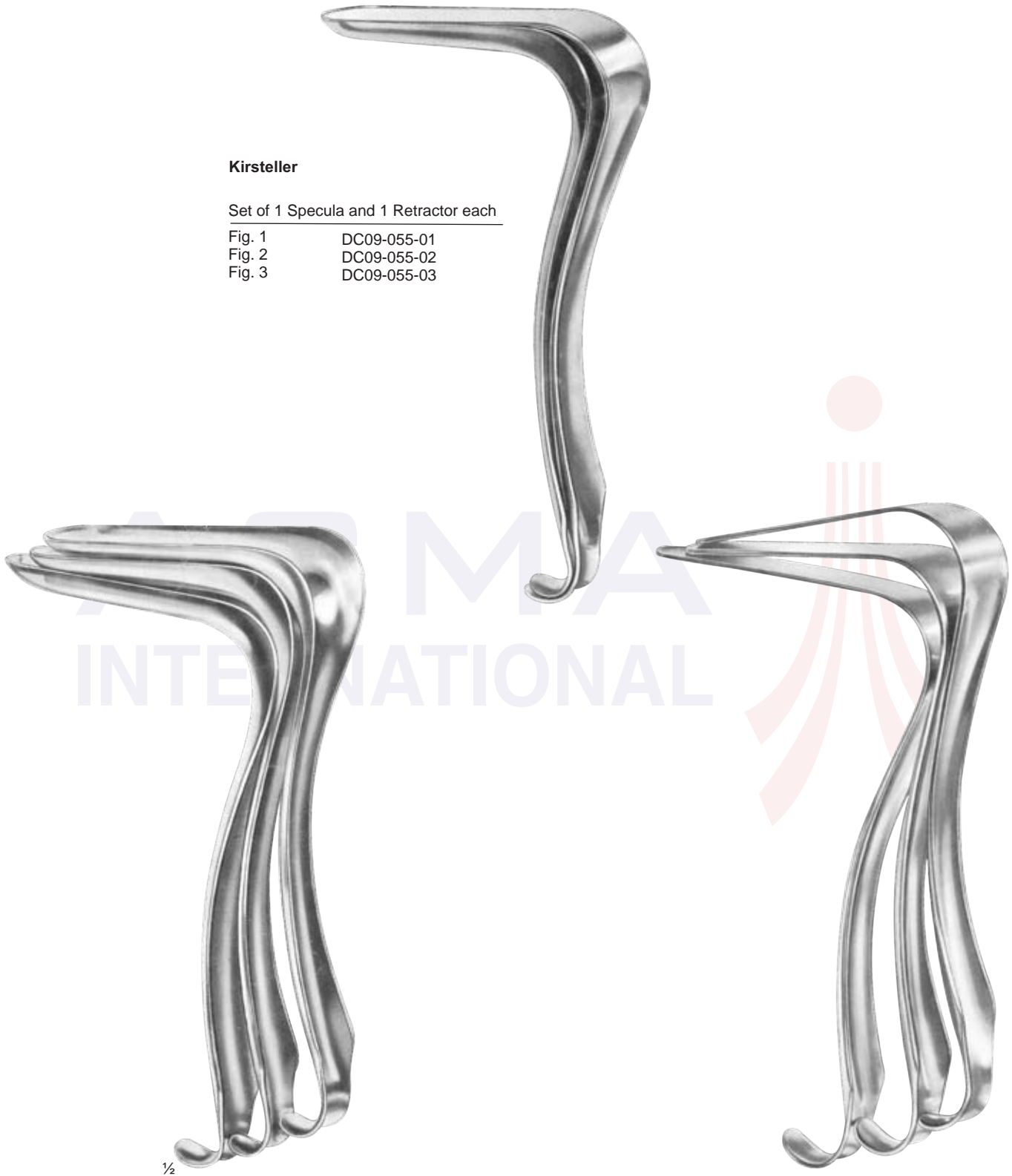
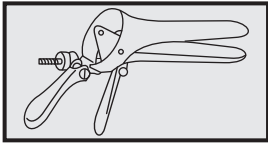

Fig.	a mm	b mm	Specula
1	110	27	DC09-057-01
2	110	30	DC09-057-02
3	110	36	DC09-057-03

Fig.	a mm	b mm	Retractors
1	115	23	DC09-059-01
2	115	26	DC09-059-02
3	115	32	DC09-059-03



Specula deep hollow

Kirsteller

Set of 1 Speculum and 1 Retractor each

Fig. 1	DC09-061-01
2	DC09-061-02
3	DC09-061-03



Kirsteller

Fig.	a mm	b mm	Specula
1	110	27	DC09-063-01
2	110	30	DC09-063-02
3	110	36	DC09-063-03

Kirsteller

Fig.	a mm	b mm	Retractors
1	115	23	DC09-065-01
2	115	26	DC09-065-02
3	115	32	DC09-065-03

Vaginal Specula and Retractors

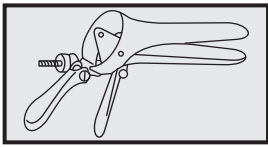

Kallmorgen

vaginal Specula

a b
Fig. mm mm

1	70	40	DC09-067-01
2	90	40	DC09-067-02

vaginal Retractors

a b
Fig. mm mm set

1	70	30	DC09-069-01	DC09-071-01
2	90	30	DC09-069-02	DC09-071-02

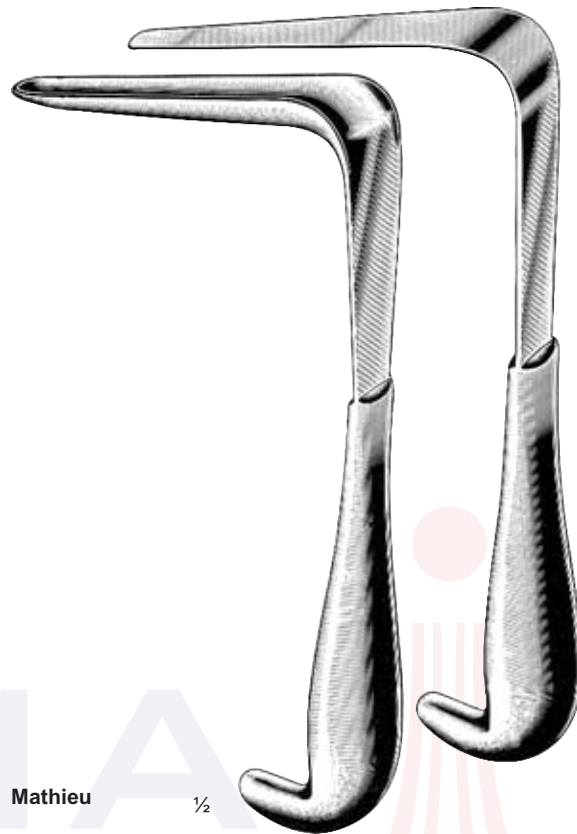

Mathieu

vaginal Specula

a b
Fig. mm mm

100	13/23	DC09-073-01
100	16/30	DC09-073-02

for virgins

vaginal Retractors

a b
Fig. mm mm set

1*	100	11/21	DC09-075-01	DC09-077-01
2	100	14/27	DC09-075-02	DC09-077-02



Barun
DC09-079-01
18 cm / 7"

1/2

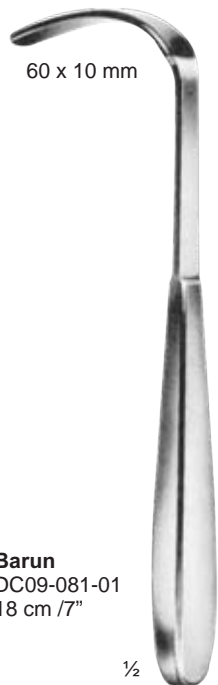

Barun
DC09-081-01
18 cm / 7"

1/2



Ulrich
DC09-083-01
19.5 cm / 7 1/2"

1/2

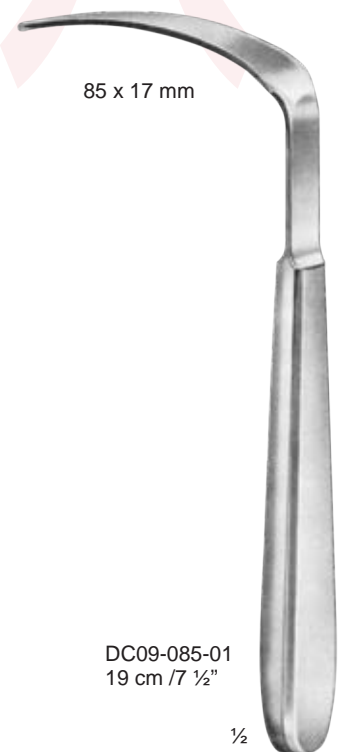

DC09-085-01
19 cm / 7 1/2"

1/2

Vaginal Specula

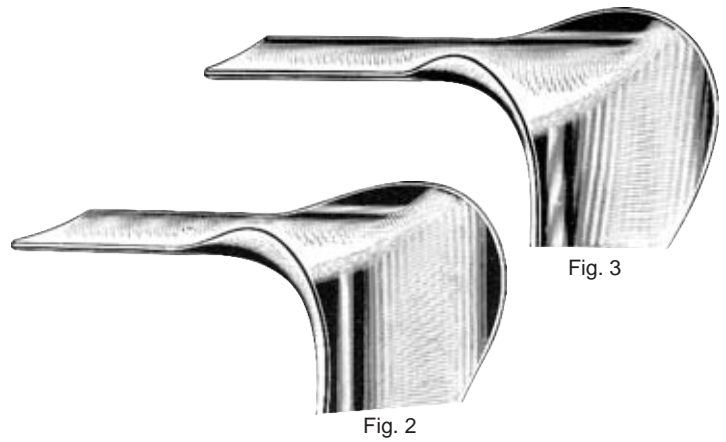
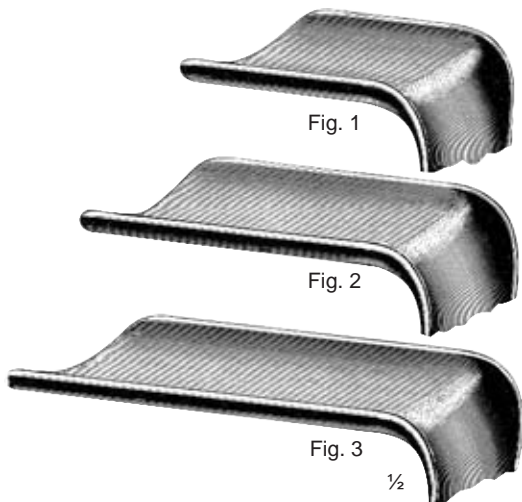
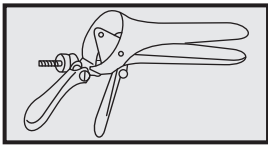
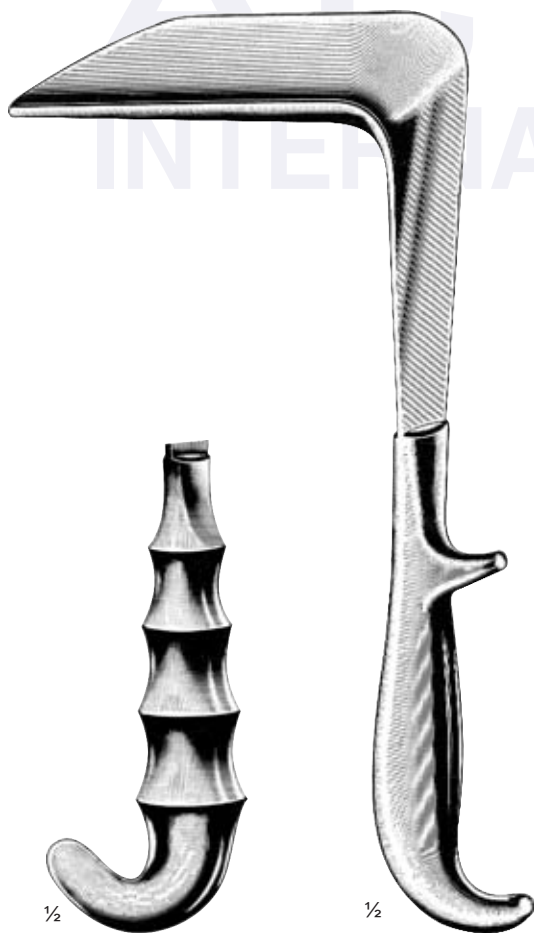

Fig.	a mm	b mm	slightly-concave	slightly-concave (MPF)	medium-concave
1	55	35	DC09-087-01		DC09-097-01
2	85	35	DC09-087-02		DC09-097-02
3	115	35	DC09-087-03		DC09-097-03
1	55	45	DC09-089-01	DC09-093-01	DC09-099-01
2	85	45	DC09-089-02	DC09-093-02	DC09-099-02
3	115	45	DC09-089-03	DC09-093-03	DC09-099-03
1	55	60	DC09-091-01	DC09-095-01	DC09-101-01
2	85	60	DC09-091-02	DC09-095-02	DC09-101-02
3	115	60	DC09-091-03	DC09-095-03	DC09-101-03

Fig.	a mm	b mm
DC09-103-01 = 1	55	45
DC09-103-02 = 2	85	45
DC09-103-03 = 3	115	45



Doyen MPF
DC09-093-01 - DC09-095-03

Doyen
DC09-087-01 - DC09-091-03
DC09-097-01 - DC09-101-03

Doyen

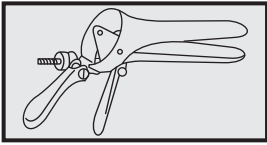

Vaginal Specula

Blades fitting on Scherbak and Bozemann Handles



- DC09-105-00 - Set consisting of handle A and B and 8 blades
- DC09-105-01 - DC09-105-08 - Blades only
- DC09-105-14 - DC09-105-15 - Handles A and B only
- DC09-107-00 - Set consisting of handle, weight and 5 blades
- DC09-107-01 - DC09-107-05 - Blades only
- DC09-107-10 - Weight, only, light, 400 grs.
- DC09-107-12 - ditto, heavy, 800 grs.
- DC09-107-14 - Handle only

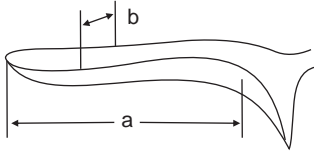
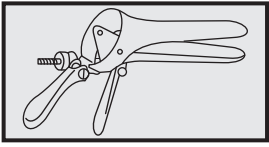

Other patterns on request

with detachable weight of 2.3 lbs



1/3

Auvard
a b
mm mm
75 40
DC09-109-11

with fixed weight



1/3

Auvard
a b
mm mm kg lbs
83 38 1.14 2.5
DC09-111-11

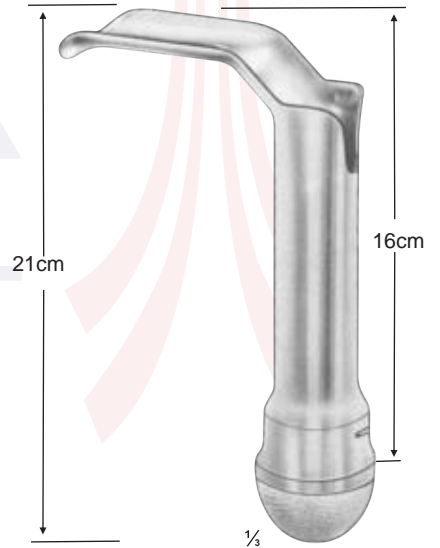

1/3

Weissbarth
21 cm 8 1/4"
a b
mm mm
80 42
DC09-113-21

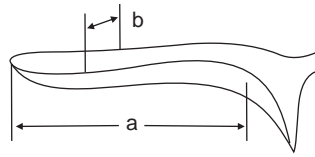
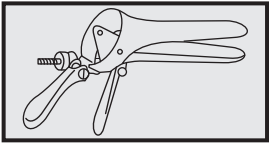

Breisky
29cm/11½"

Breisky
32cm/12½"

Breisky
35cm/13¾"

Breisky
37cm/14¼"

	a	b		a	b		a	b
DC09-115-20	100	20mm	DC09-117-20	130	20mm	DC09-119-20	160	20mm
DC09-115-25	100	25mm	DC09-117-25	130	25mm	DC09-119-25	160	25mm
DC09-115-30	100	30mm	DC09-117-30	130	30mm	DC09-119-30	160	30mm
DC09-115-35	100	35mm	DC09-117-35	130	35mm	DC09-119-35	160	35mm
DC09-115-40	100	40mm	DC09-117-40	130	40mm	DC09-119-40	160	40mm
						DC09-121-20	180	20mm
						DC09-121-25	180	25mm
						DC09-121-30	180	30mm
						DC09-121-35	180	35mm
						DC09-121-40	180	40mm

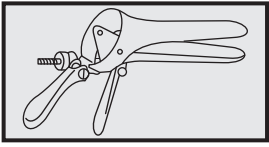

½

Landau
DC09-123-01 - DC09-123-02

a mm	b mm	
100	28	DC09-123-01
100	38	DC09-123-02



½

Dunkel
DC09-125-22

95 x 45 mm

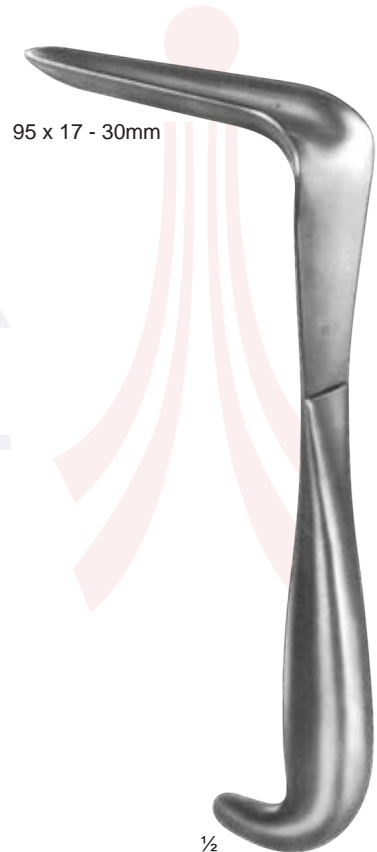

½

Mathieu
DC09-127-21
21cm/8¼"

95 x 17 - 30mm

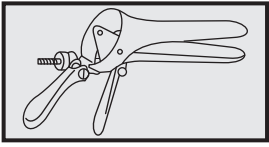

70 x 30 mm

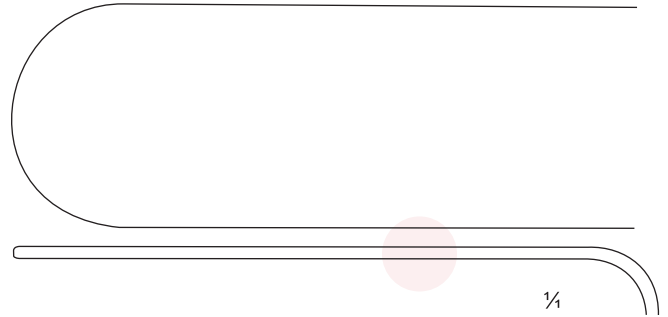

95 x 17 - 26mm

for children and virgins

1/2

Mathieu
DC09-129-21
21cm/8 1/4"

85 x 32 mm

1/2

Olshausen
DC09-133-21
21 cm/8 1/4"

1/2

Doyen
DC09-131-24
24 cm /9 3/4"

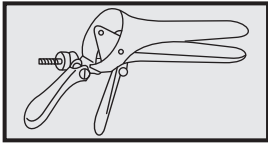

Retractors, Endospecula



1/2

Friedman
DC09-135-10
10 cm /4"

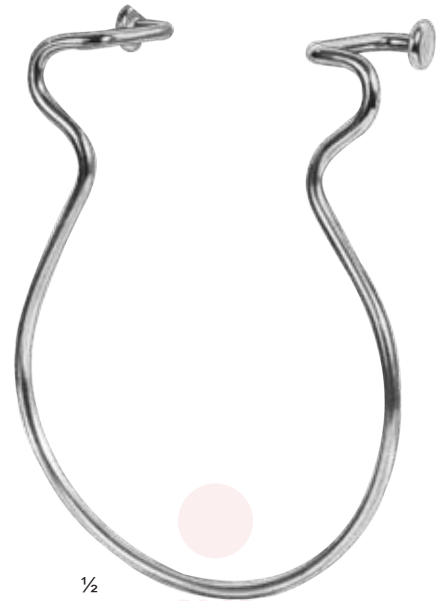

1/2

Stieglitz
DC09-137-12 = 12 x 12 cm /4 3/4 x 4 3/4"
DC09-137-14 = 14 x 14 cm /5 1/2 x 5 1/2"



1/4

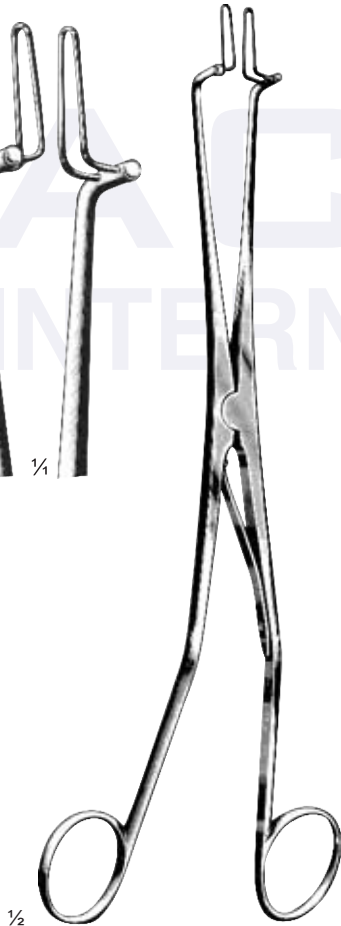

1/2

Kogan
DC09-139-24
24 cm /9 1/2"



1/2



Kogan
DC09-141-24
24 cm /9 1/2"

Tenaculum Forceps
Also Towel Forceps

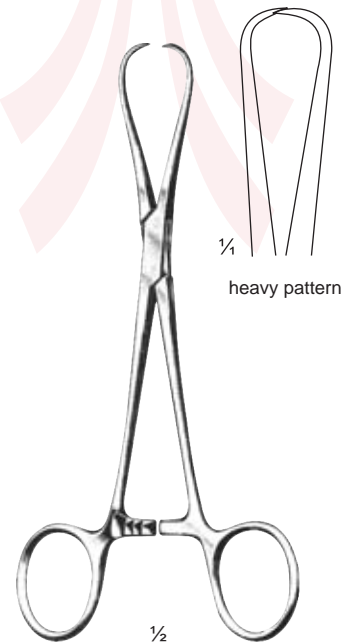

1/4

heavy pattern

1/2

Staude-Moore (Bernhard)
DC09-143-17
17cm/6 3/4"

- DC09-135-10
- DC09-137-12 - DC09-137-14
- DC09-139-24
- DC09-141-24

- Retractor, self-retaining, for perineorrhaphy
- Vulva Retractors
- Endospecula for cervix and urethra, with S-shaped curve and fenestrated jaws
- without ratchet
- with scale-ratchet and fixing screws

Tenaculum Forceps

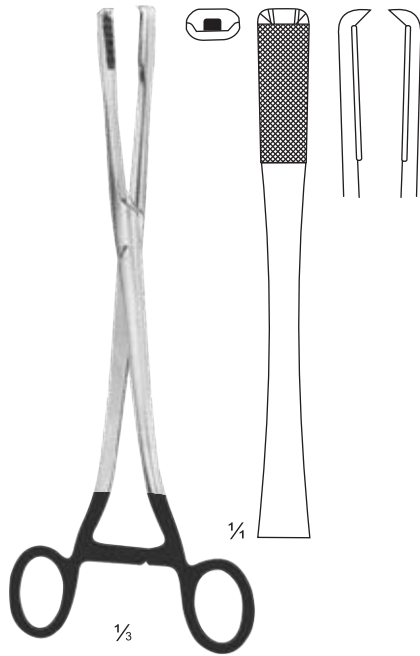
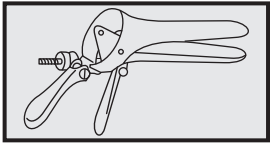

H. G. Muller
DC09-145-24
24 cm / 9 1/2"

with guide blades

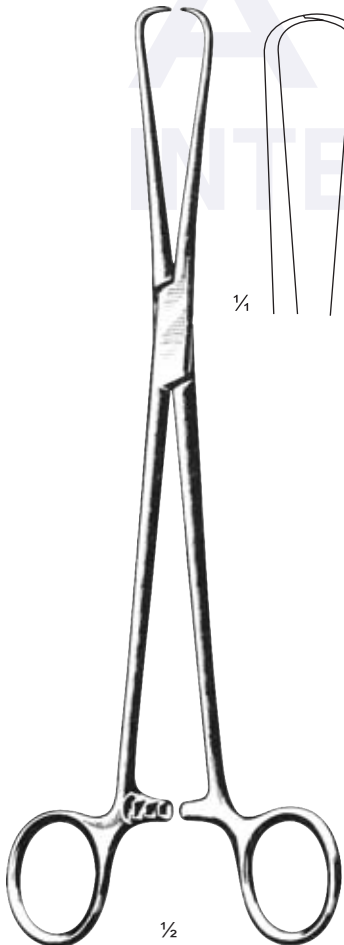
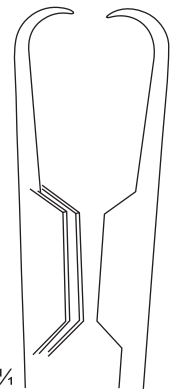

Schroeder
DC09-147-25
25cm/10"

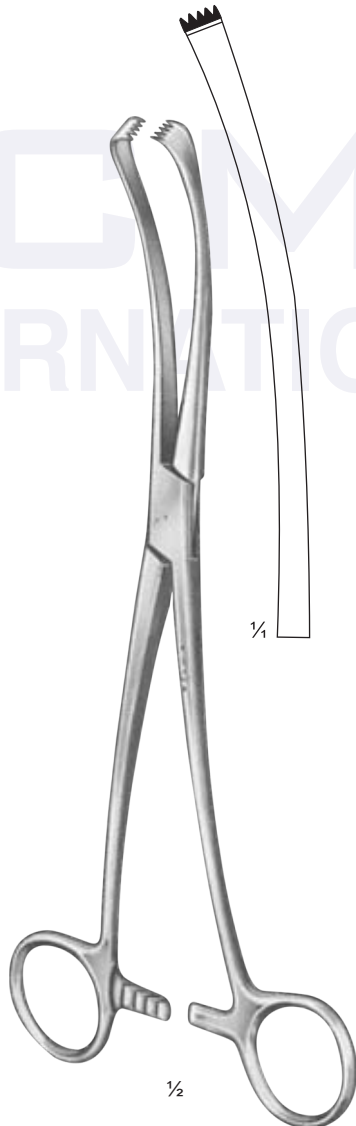

Iowa
DC09-149-26
26cm/10 1/4"

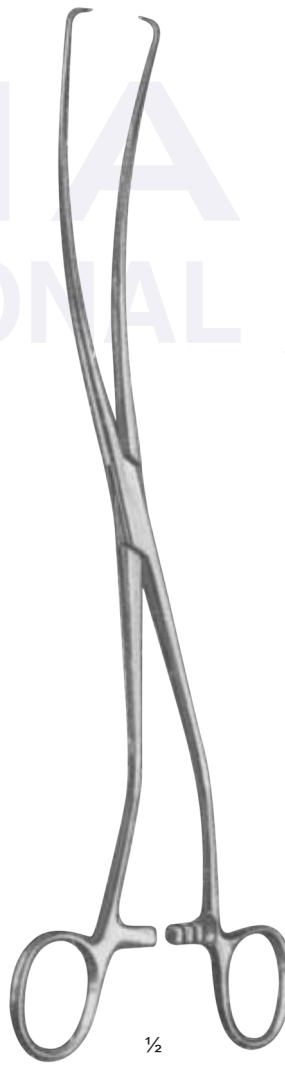

Duplay
DC09-151-28
28cm/11"

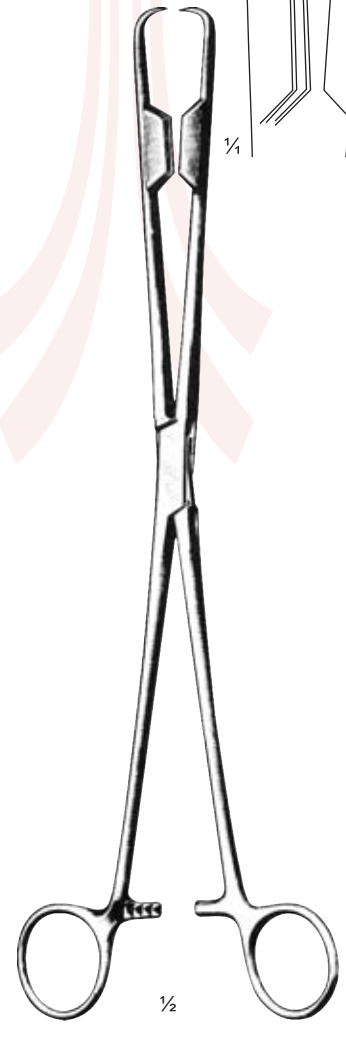

Abel
DC09-153-27
27cm/10 1/2"

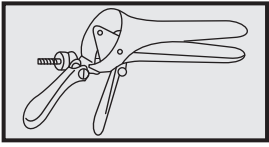

Tenaculum Forceps

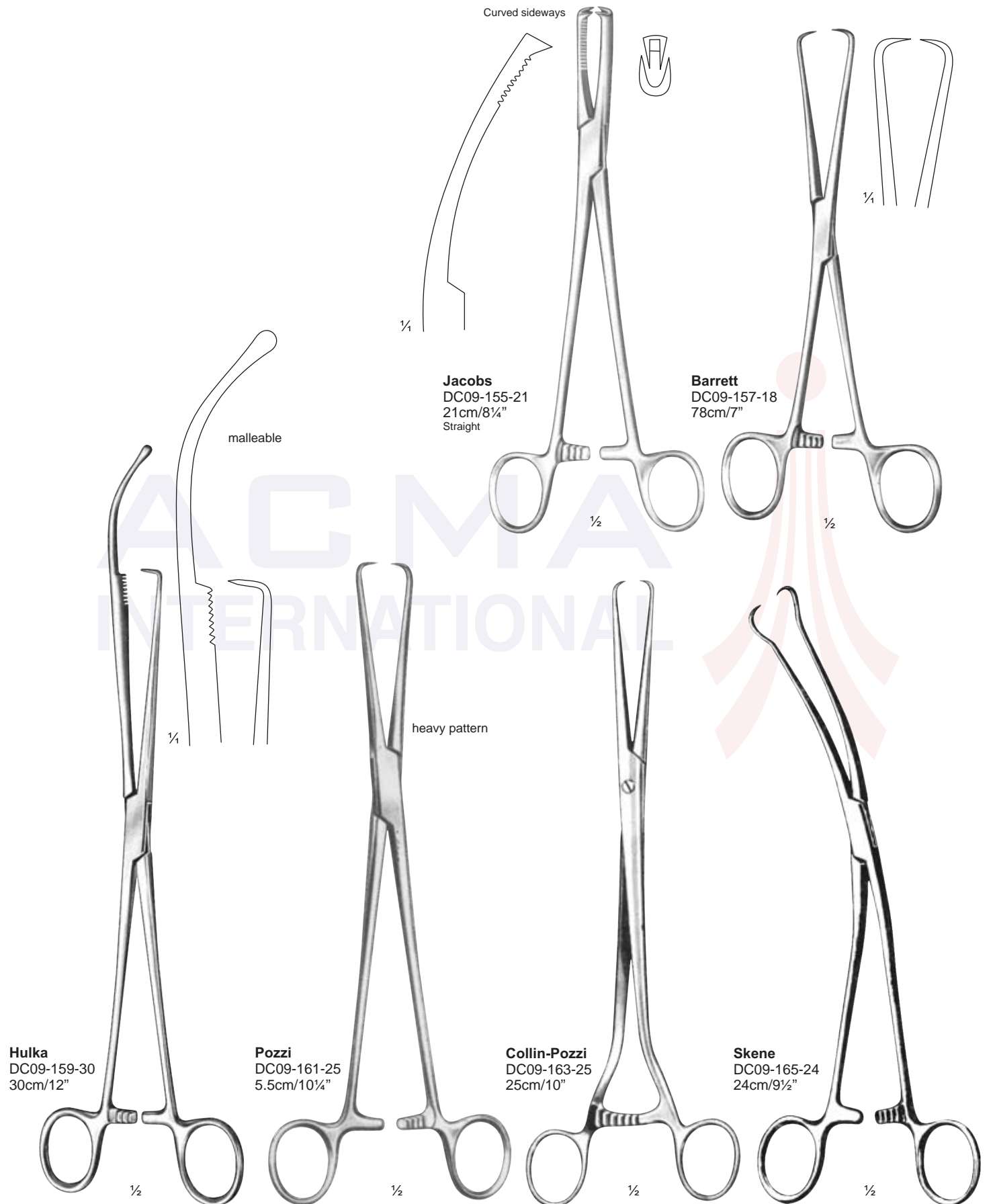

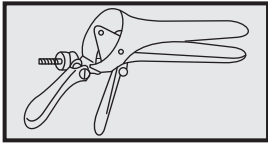

Tenaculum Forceps

Also Goitre Seizing Forceps

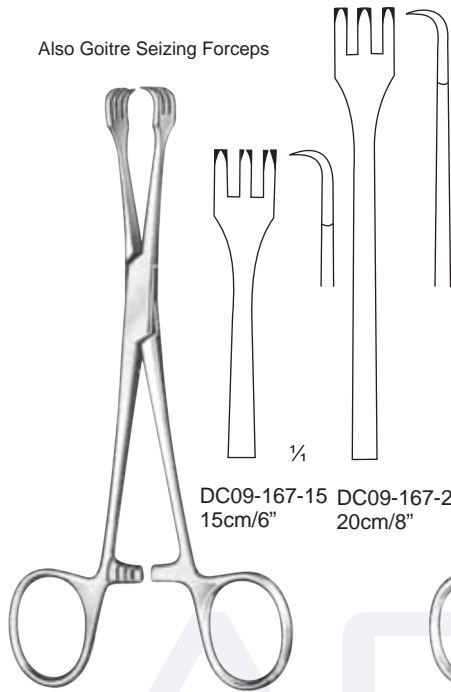

DC09-167-15 15cm/6"
DC09-167-20 20cm/8"

Lahey

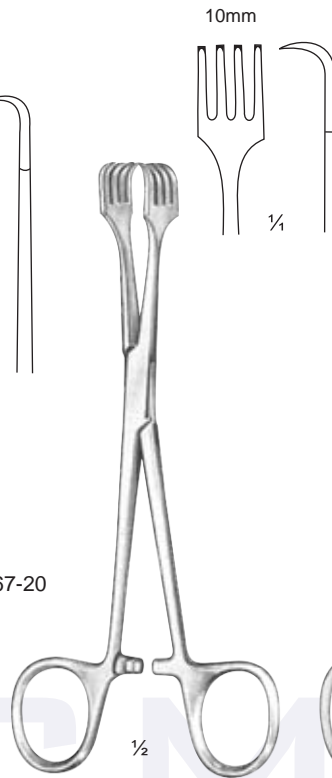

Brown
DC09-169-15
15.5cm/6 1/4"

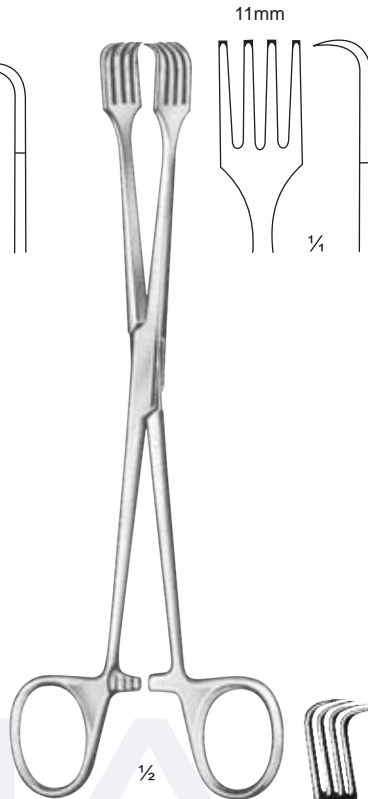

Czerny
DC09-171-20
20.5cm/8 1/4"



Amniotome
for the amnion
bladder

1/3

Beacham
DC09-173-26
26 cm /10 1/4"

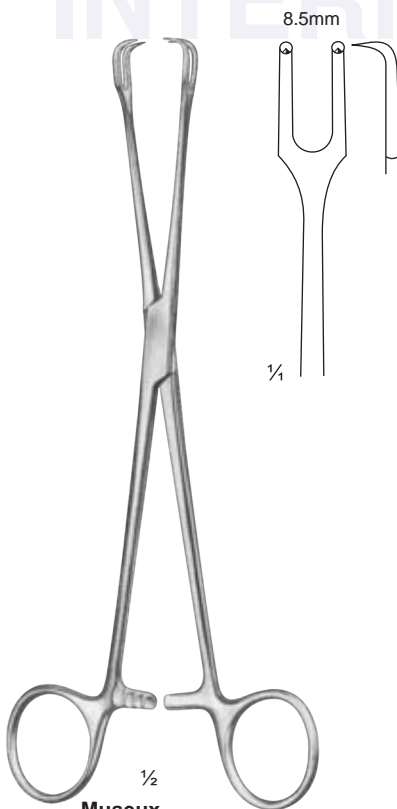

Museux
DC09-175-20
20cm/8"

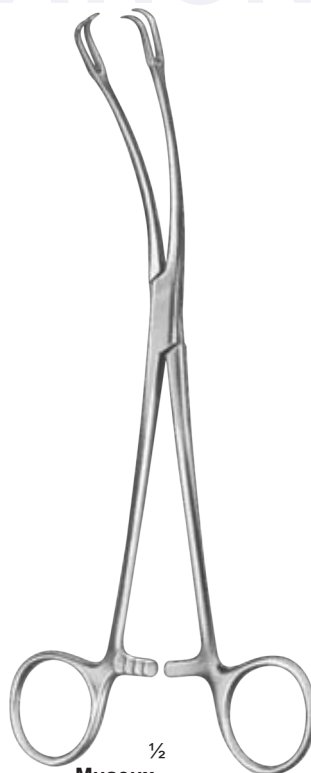

Museux
DC09-177-20
20cm/8"

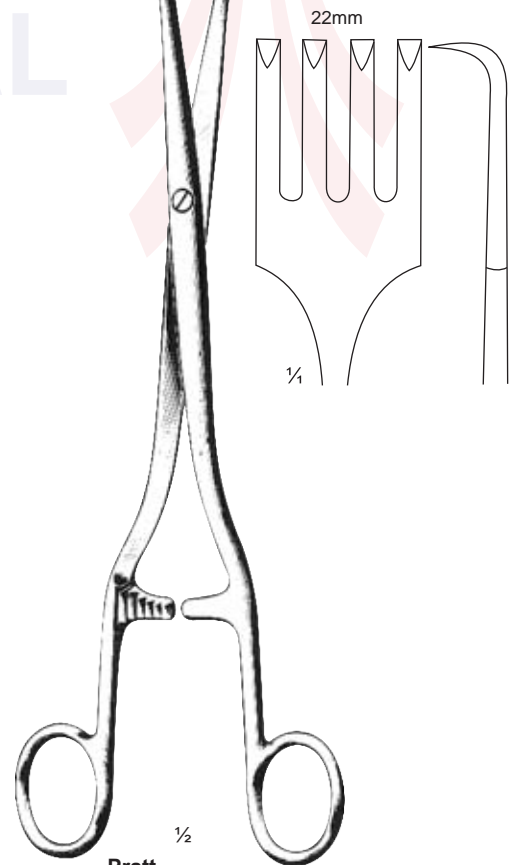

Pratt
DC09-179-28
28cm/11"

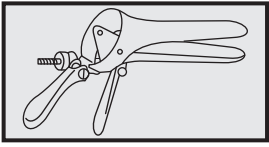

Tenaculum Forceps

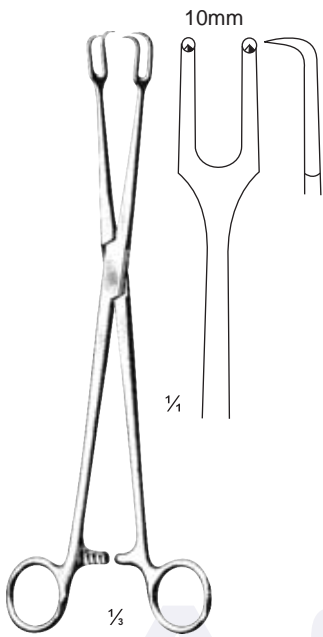

Schroeder
DC09-181-24
24cm/9½"

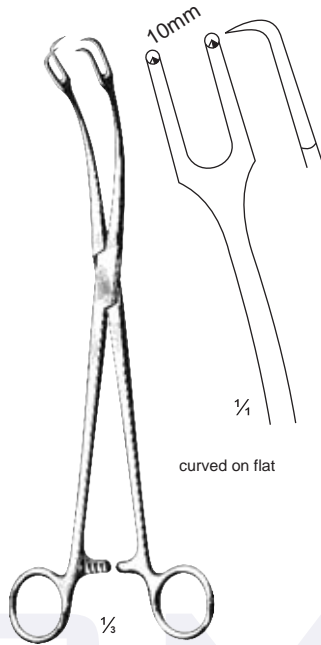

Schroeder
DC09-183-24
24cm/9½"

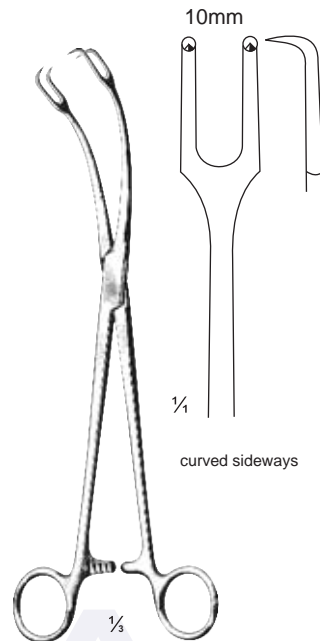

Schroeder
DC09-185-24
24cm/9½"



Teale
DC09-187-23
23cm/9"

curved sideways

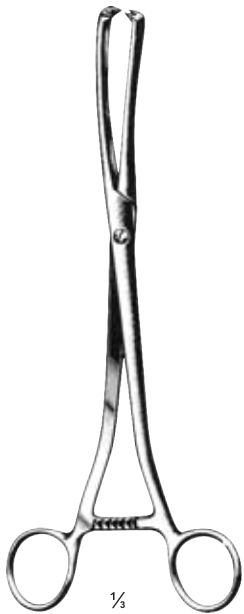

Museux
DC09-189-06= 6mm
DC09-189-08= 8mm
DC09-189-10= 10mm
24cm/9½"

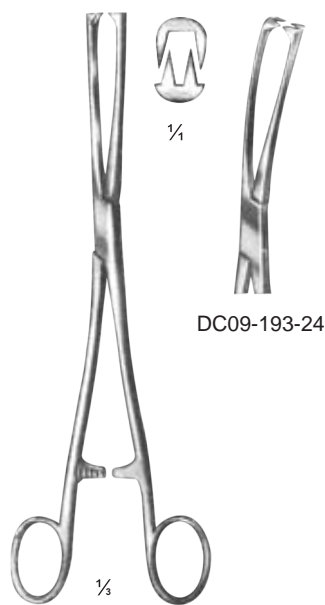

Museux
DC09-191-24
24cm/9½"

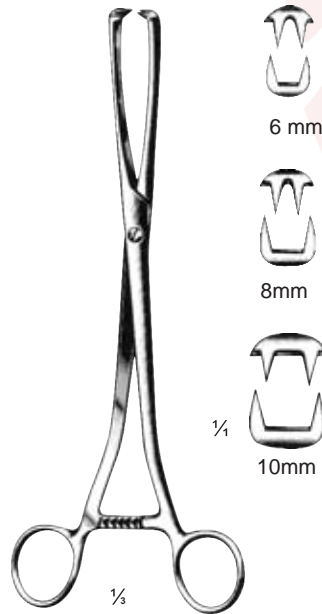

Museux
DC09-195-06= 6mm
DC09-195-08= 8mm
DC09-195-10= 10mm
24cm/9½"



Henrotin
DC09-197-20
20.5 cm /8"

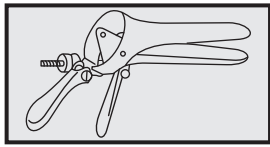

Uterine Polypus Forceps, Uterine Elevating Forceps

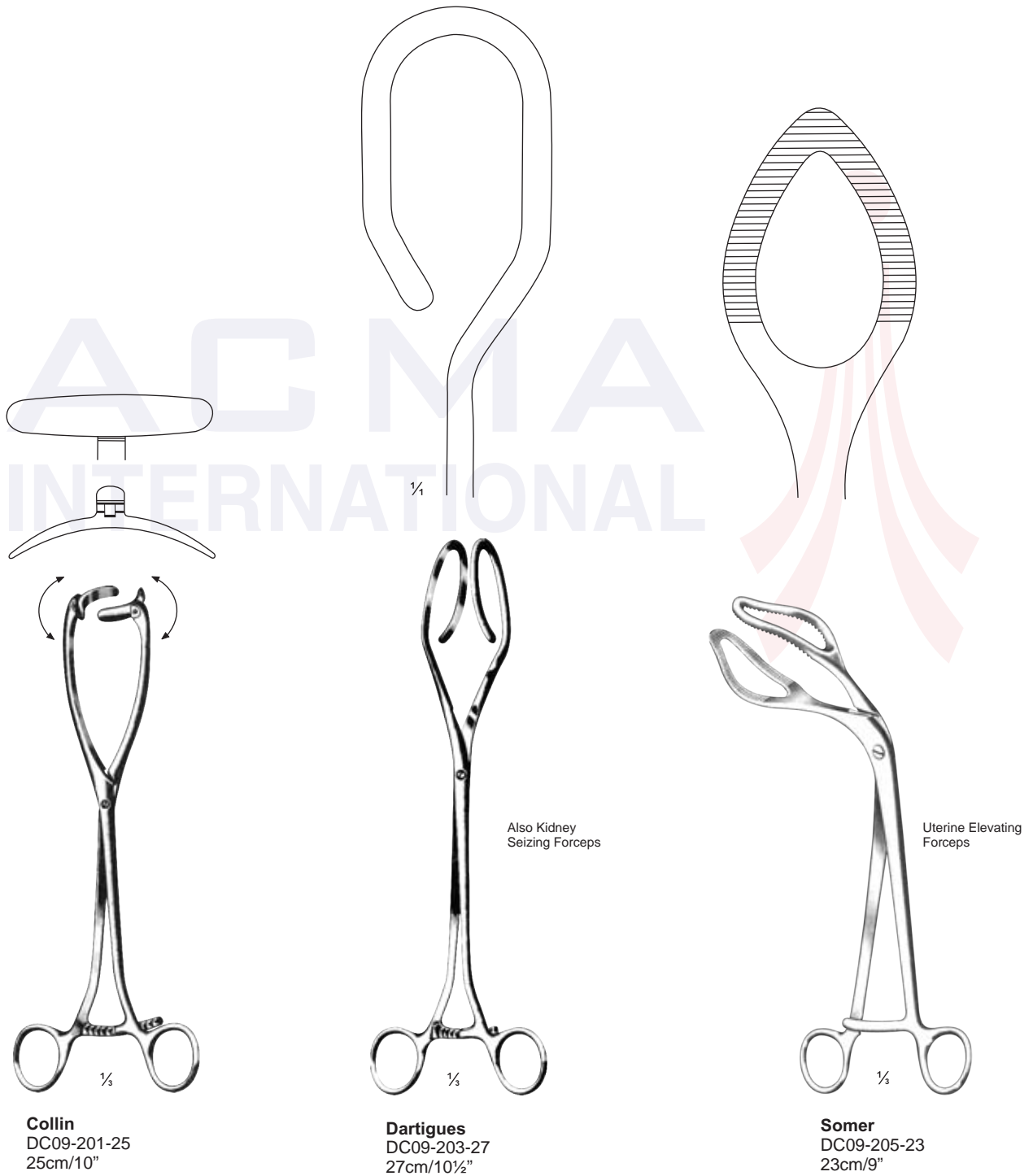

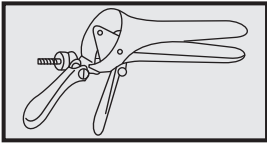

Uterine Polypus Forceps, Overrain Forceps



1/3

Doyen
DC09-207-20
20 cm / 8"



1/3

Pruesmann
DC09-209-27
27.5 cm / 10 3/4"

Uterine Polypus Forceps,
Ovarian Forceps



1/4

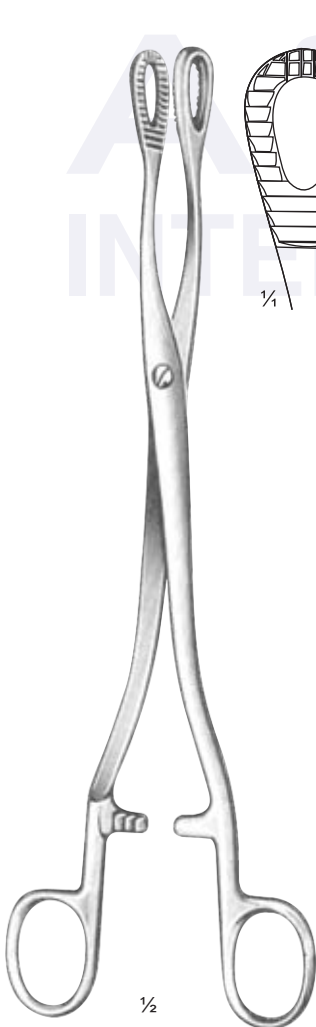

1/2

Heywood-Smith
DC09-211-25
25cm/10"

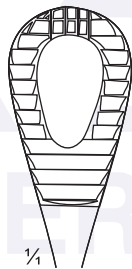

1/4

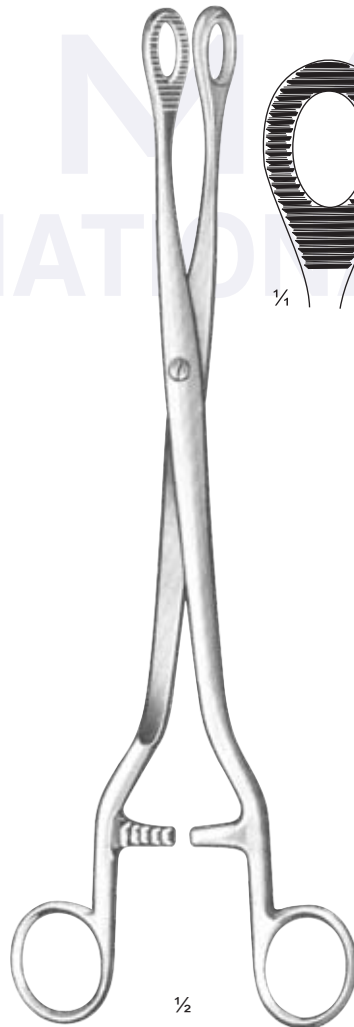

1/2

Noto
DC09-213-27
27cm/10 1/2"



1/4

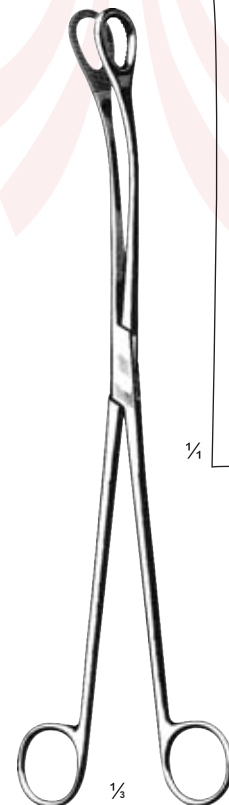

1/4

Kelly
DC09-215-32
32cm/12 1/2"

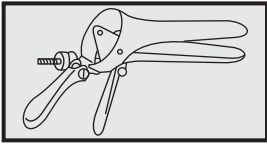

Wylie
DC09-221-29
29 cm /11 1/2"
with smooth jaws



DC09-223-29
with serrated jaws

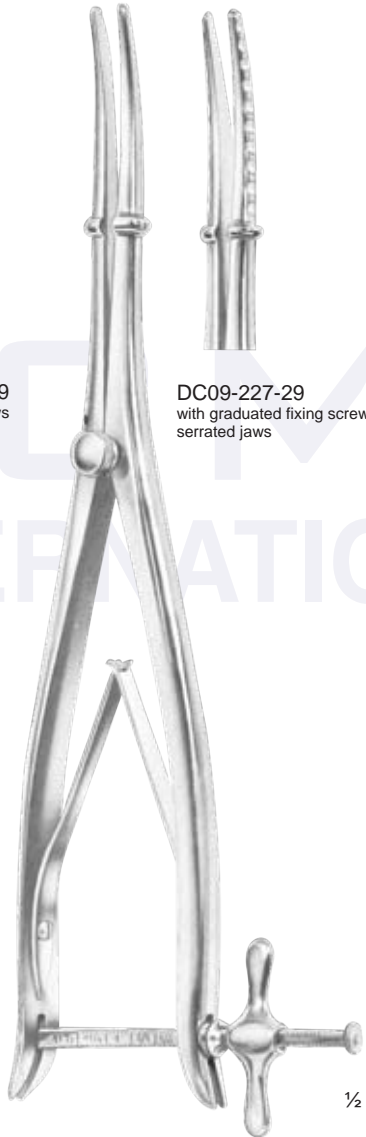

Wylie
DC09-225-29
29 cm /11 1/2"
with graduated fixing screw,
smooth jaws



DC09-227-29
with graduated fixing screw,
serrated jaws



Sims
DC09-229-29
29 cm /11 1/2"
with fixing screw, three-bladed,
smooth jaws

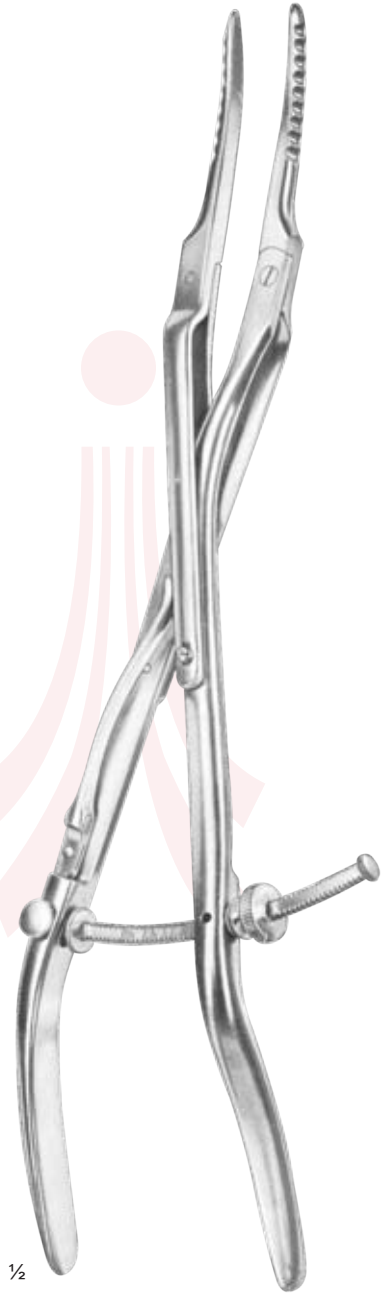

Goodell
DC09-231-34
34 cm /13 1/2"
with graduated fixing screw,
serrated jaws

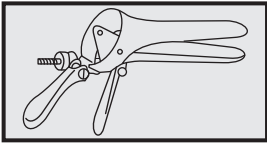

Uterine Dilators



pieces per set		Set	Set	Set
14	4.0-17.0	DC09-233-80	DC09-237-80	DC09-239-80
23	4.0-26.0			
26	1.0-26.0	DC09-233-90	DC09-237-90	DC09-239-85

mm ø	with sloped handle	with serrated handle	with tube
1.0	DC09-233-01		DC09-237-01
1.5		DC09-235-01	
2.0	DC09-233-02		DC09-237-02
2.5		DC09-235-02	
3.0	DC09-233-03		DC09-237-03
3.5		DC09-235-03	
4.0	DC09-233-04		DC09-237-04
4.5		DC09-235-04	DC09-239-04
5.0	DC09-233-05		DC09-237-05
5.5		DC09-235-05	DC09-239-05
6.0	DC09-233-06		DC09-237-06
6.5		DC09-235-06	DC09-239-06
7.0	DC09-233-07		DC09-237-07
7.5		DC09-235-07	DC09-239-07
8.0	DC09-233-08		DC09-237-08
8.5		DC09-235-08	DC09-239-08
9.0	DC09-233-09		DC09-237-09
9.5		DC09-235-09	DC09-239-09
10.0	DC09-233-10		DC09-237-10
10.5		DC09-235-10	DC09-239-10
11.0	DC09-233-11		DC09-237-11
11.5		DC09-235-11	DC09-239-11
12.0	DC09-233-12		DC09-237-12
12.5		DC09-235-12	DC09-239-12
13.0	DC09-233-13		DC09-237-13
13.5		DC09-235-13	DC09-239-13
14.0	DC09-233-14		DC09-237-14
14.5		DC09-235-14	DC09-239-14
15.0	DC09-233-15		DC09-237-15
15.5		DC09-235-15	DC09-239-15
16.0	DC09-233-16		DC09-237-16
16.5		DC09-235-16	DC09-239-16
17.0	DC09-233-17		DC09-237-17
17.5		DC09-235-17	DC09-239-17
18.0	DC09-233-18		DC09-237-18
18.5		DC09-235-18	DC09-239-18
19.0	DC09-233-19		DC09-237-19
19.5		DC09-235-19	DC09-239-19
20.0	DC09-233-20		DC09-237-20
21.0	DC09-233-21		DC09-239-21
22.0	DC09-233-22		DC09-239-22
23.0	DC09-233-23		DC09-239-23
24.0	DC09-233-24		DC09-239-24
25.0	DC09-233-25		DC09-239-25
26.0	DC09-233-26		DC09-239-26
27.0	DC09-233-27		
28.0	DC09-233-28		
29.0	DC09-233-29		
30.0	DC09-233-30		



DC09-233-82
Set of 14 dilators DC09-233-04 - DC09-233-17
(4.0-17.0 mm ø), in pouch

Uterine Dilators

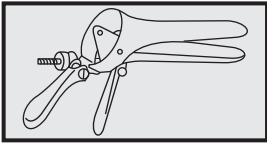

mm ø

1.0/ 2.0	DC09-241-02
3.0/ 4.0	DC09-241-04
5.0/ 6.0	DC09-241-06

7.0/ 8.0	DC09-241-08
9.0/ 10.0	DC09-241-10
11.0/ 12.0	DC09-241-12

13.0/14.0	DC09-241-14
15.0/16.0	DC09-241-16
17.0/18.0	DC09-241-18

19.0/20.0	DC09-241-20
21.0/22.0	DC09-241-22
23.0/24.0	DC09-241-24
25.0/26.0	DC09-241-26



DC09-241-80
Set of 8 dilators 3.0/4.0-17.0/18.0 mm ø

DC09-241-90
Set of 13 dilators 1.0/2.0-25.0/26.0 mm ø

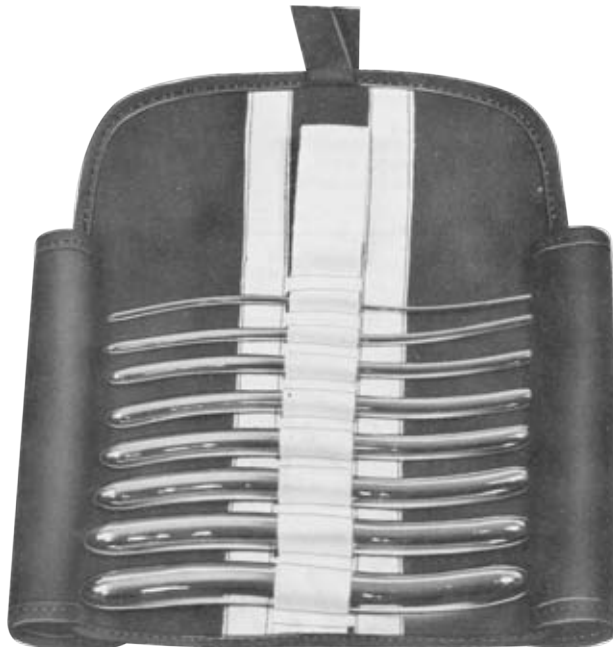

DC09-241-82
Set of 8 dilators 3.0/4.0-17.0/18.0 mm ø in pouch

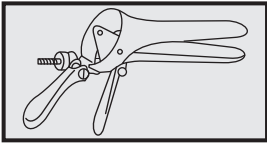

Hank
DC09-243-10 -
DC09-243-20



Hank
DC09-243-80
set

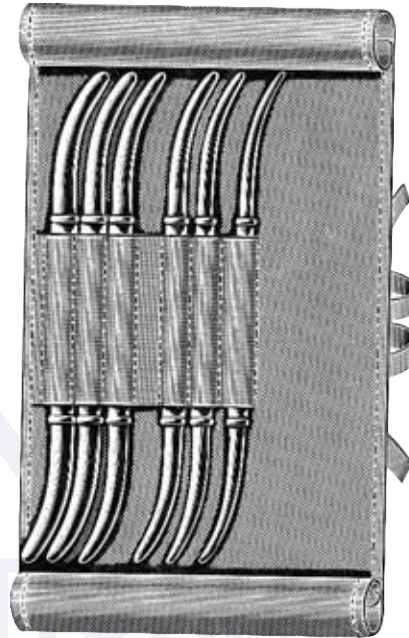

DC09-243-82
set

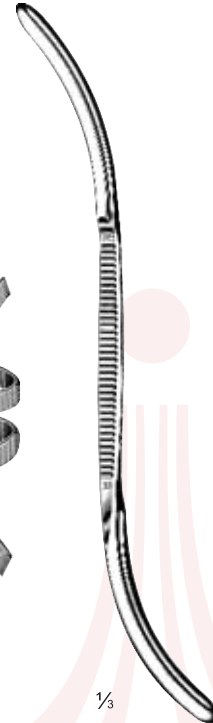

Landau
DC09-245-15
DC09-245-80



Jolly
DC09-247-05 -
DC09-247-07

American scale		Hank
Fig.	mm ø	
9/10	4.5/5	DC09-243-10
11/12	5.5/6	DC09-243-12
13/14	6.5/7	DC09-243-14
15/16	7.5/8	DC09-243-16
17/18	8.5/9	DC09-243-18
19/20	9.5/10	DC09-243-20

- DC09-243-10 - DC09-243-20 - with conical point, double-ended, single
- DC09-245-15 - DC09-245-30 - Set of 6 pieces
- DC09-243-80, DC09-245-80 - ditto, in pouch
- DC09-243-82 - Conical shape, with bow fitting
- DC09-247-05 - Set of 5 pieces: 3-7, 5-7, 7-12, 9-15, and 12-18 mm ø
- DC09-247-07 - Set of 7 pieces: 3-7, 5-9, 7-12, 9-15, 12-18, 15-21 and 18-24 mm ø

Uterine Sounds and Depressors, Sponge Holders

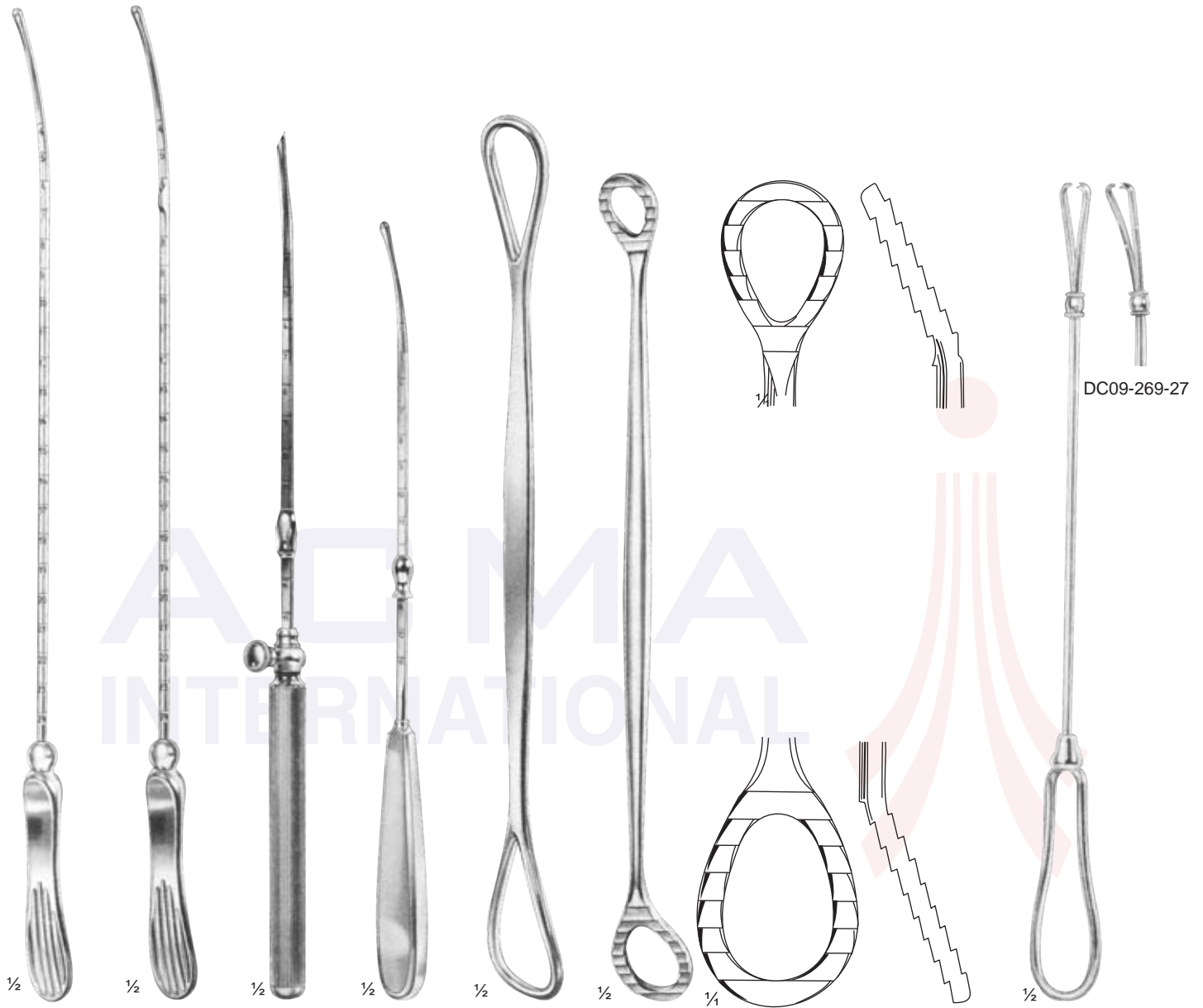
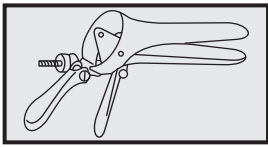

Sims DC09-249-32 DC09-251-32 32 cm /12 1/2"	Martin DC09-253-32 DC09-255-32 DC09-257-32 DC09-259-32 32 cm /12 1/2"	Collin DC09-260-28 28 cm /11"	Valleix DC09-261-25 25 cm /10"	Braun DC09-263-26 28 cm /11"	Sims DC09-265-26 26 cm /10 1/4"	Sims DC09-267-27 27 cm /10 1/2" 3.2 mm ø
---	---	--	---	---	--	--

- DC09-249-32 - Uterine Sound, graduated, with centimeter scale
- DC09-251-32 - ditto, malleable
- DC09-253-32 Uterine Sounds, graduated
- DC09-255-32 - with centimeter scale
- DC09-257-32 - ditto, malleable
- DC09-259-32 - ditto, with slide
- DC09-261-25 - Uterine Depressor
- DC09-263-26 - ditto, toothed working ends
- DC09-265-26 - Uterine Sponge Holders, with fenestrated handle
- DC09-267-27 - DC09-269-27

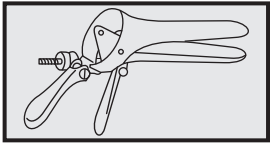

Myoma Screw and Knife, Fistula Hooks, Cone Knives



Doyen
DC09-271-17
17 cm / 6 3/4"



Doyen
DC09-273-17
17 cm / 6 3/4"
Myoma Screw (Tumor Screw)

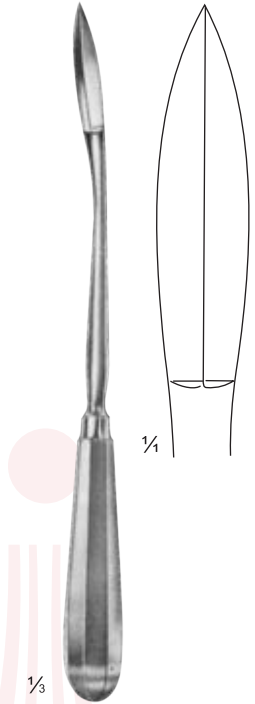

Segond
DC09-275-27
Myoma Knife

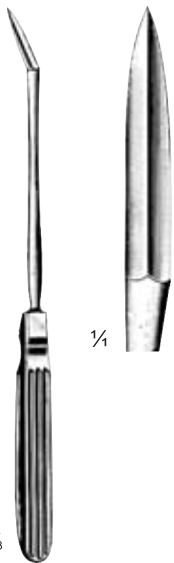

Ayre
DC09-277-23
23 cm / 9"



Emmett
22 cm / 8 3/4"
Fistula Hooks

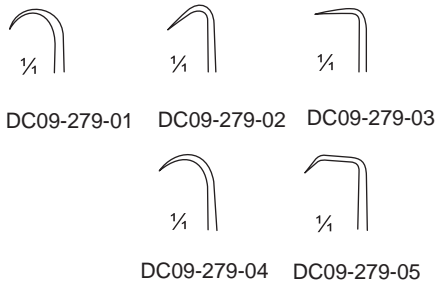

Simon
DC09-281-22
22 cm / 8 3/4"
Fistula Hooks



Simon
DC09-283-22
22 cm / 8 3/4"
Fistula Hooks

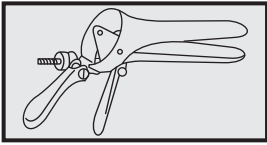

Suction Biopsy Curettes



1/2

Randall
DC09-285-24
24 cm / 9 1/2"
4 mm ø
Endometrial
Suction Biopsy Curettes



1/2

Novak
DC09-287-23
23 cm / 9"
4 mm ø
Endometrial
Suction Biopsy Curettes



1/2

Kevorkiaan
DC09-289-30
30 cm / 12"
Biopsy Curette



1/2

Mod. Muenchen
DC09-291-27
27 cm / 10 1/2"
Biopsy Curette

ACMA
INTERNATIONAL

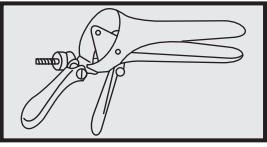

Cervical Biopsy and Specimen Forceps



Gellhorn
DC09-293-23
23 cm / 9"



Faure
DC09-295-21
21 cm / 9 1/2"

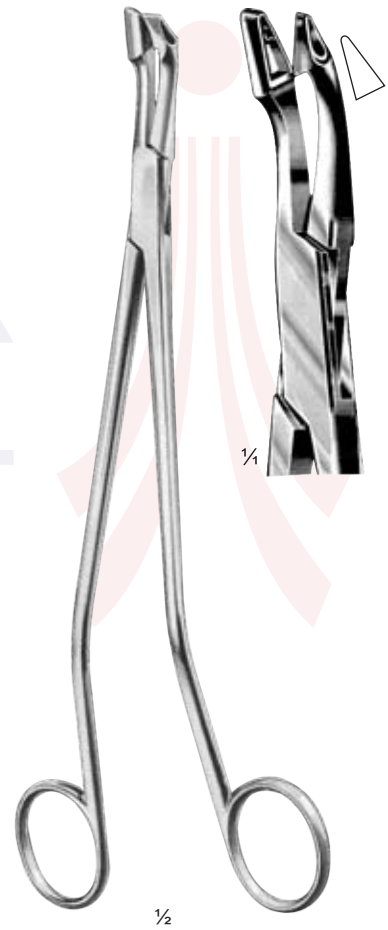

Van Doren
DC09-297-24
25 cm / 10"
Its S-shaped construction allows clear view and sharply-delineated incisions.

Cervical Biopsy and Specimen Forceps

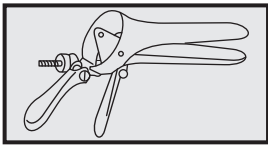

Thoms-Gaylor
DC09-299-22 = 22 cm / 8 1/2"
DC09-299-24 = 24 cm / 9 1/2"

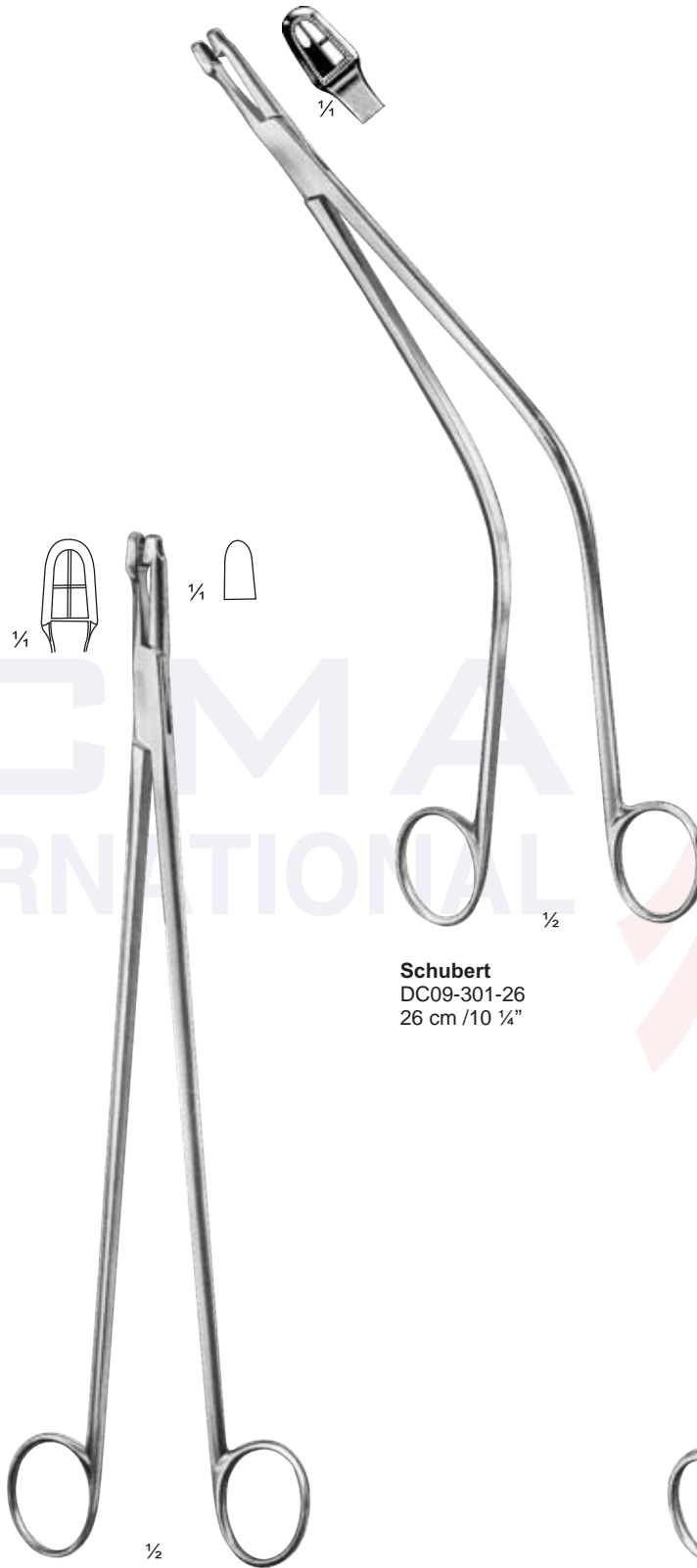

Schubert
DC09-301-26
26 cm / 10 1/4"



Schubert
DC09-303-21 = 21 cm / 8 1/4"
DC09-303-28 = 29 cm / 11 1/2"



Thoms-Galar
DC09-305-24
24 cm / 9 1/2"

Cervical Biopsy and Specimen Forceps

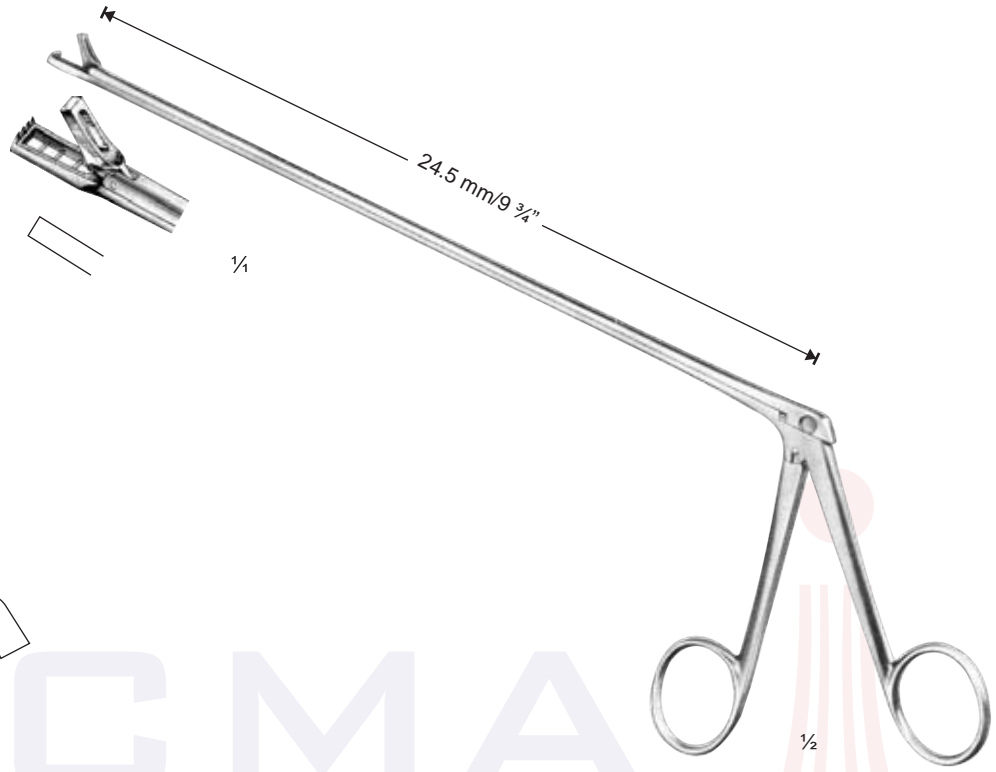
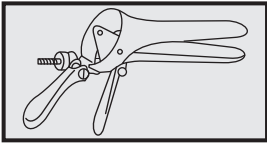

Kevorkian
DC09-307-32

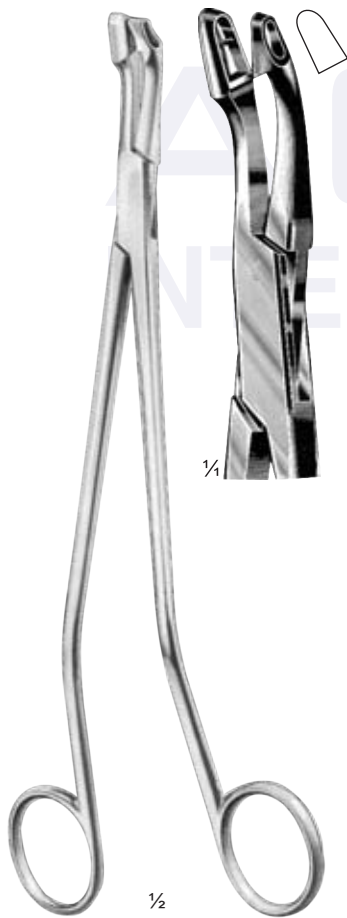

Van Doren
DC09-309-25
25 cm / 10"
Its S-shaped construction allows clear view and sharply-delineated incisions.

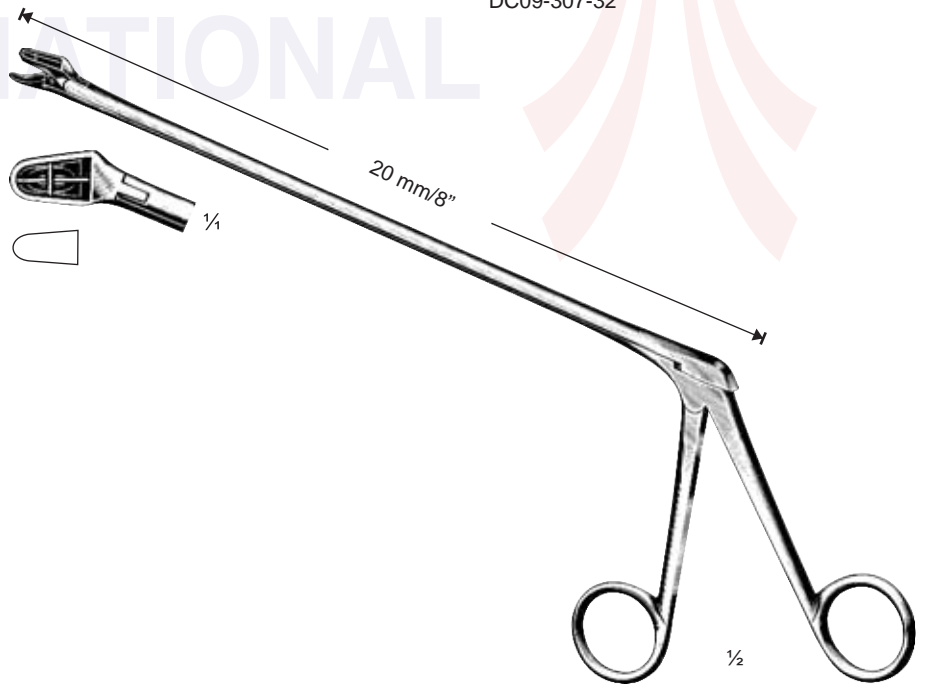

Alexander
DC09-311-28
28 cm / 11"
Jaws cut with a pulling motion from point to rear. Cutting edge planted into tissue. Better view as jaws are curved to left.

Cervical Biopsy and Specimen Forceps

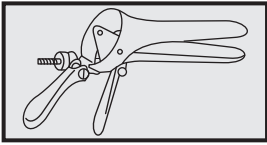

DC09-313-01
Tip only

Schumacher
DC09-313-00
Schumacher Biopsy Specimen
Forceps with exchangeable tip

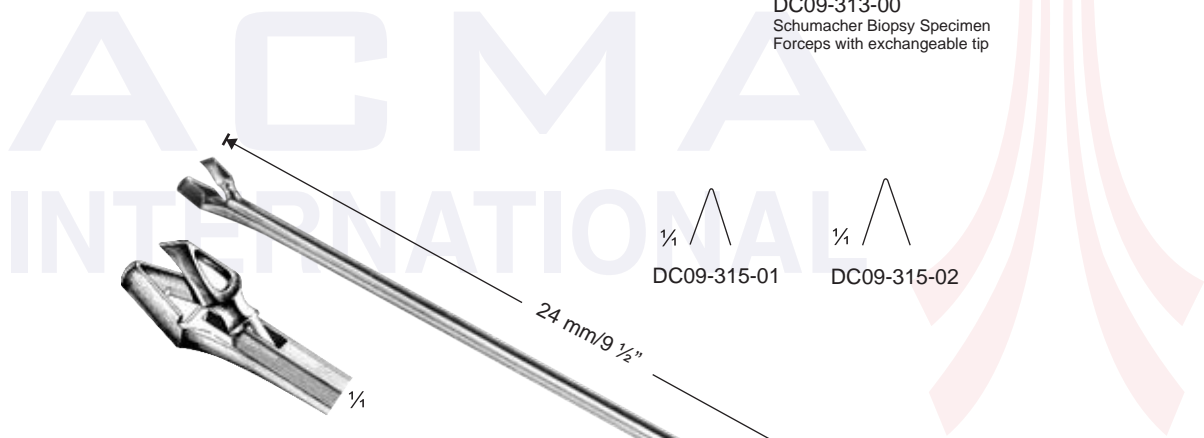

DC09-315-01

DC09-315-02

24 mm / 9 1/2"

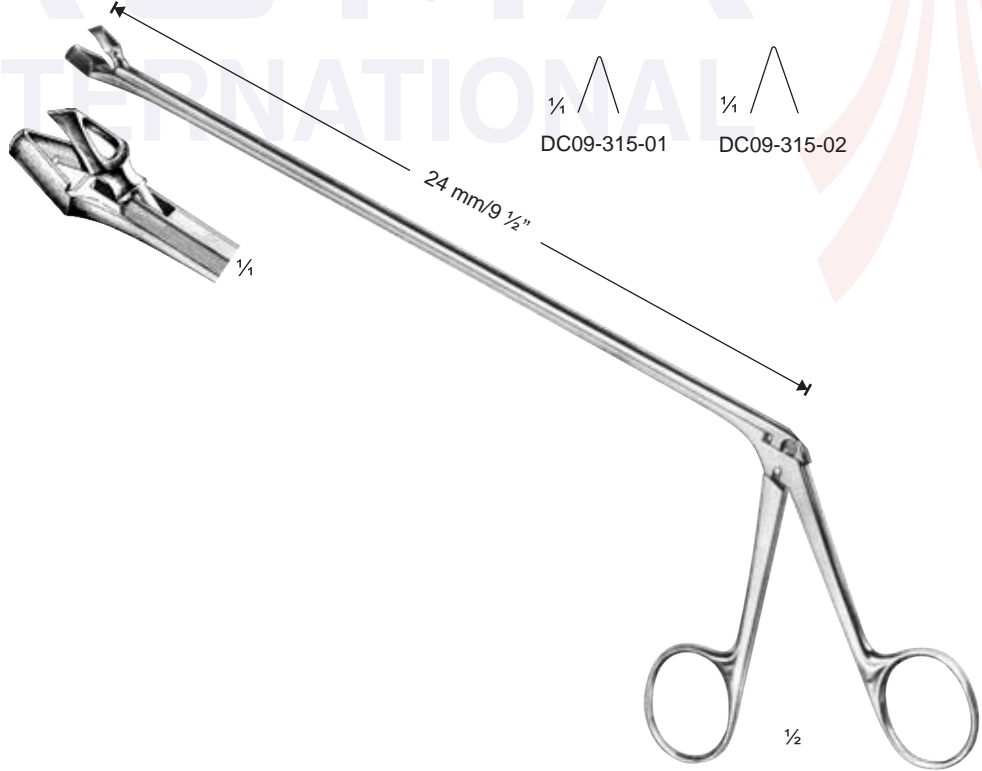

Schumacher
DC09-315-01 - 02

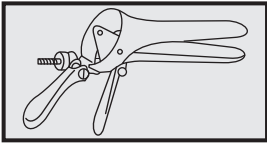

Cervical Biopsy and Specimen Forceps

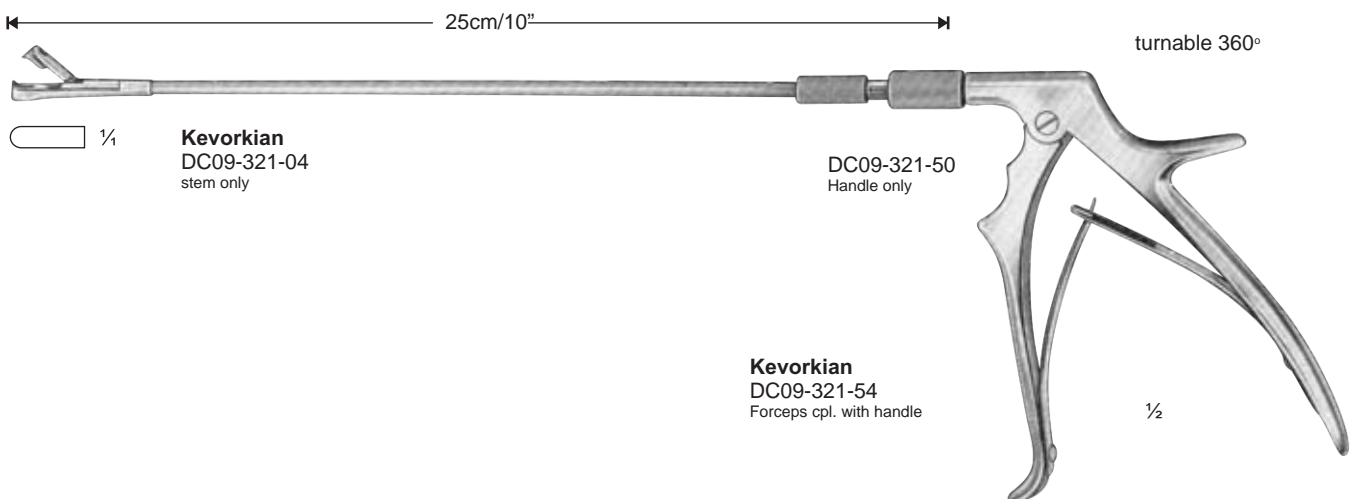
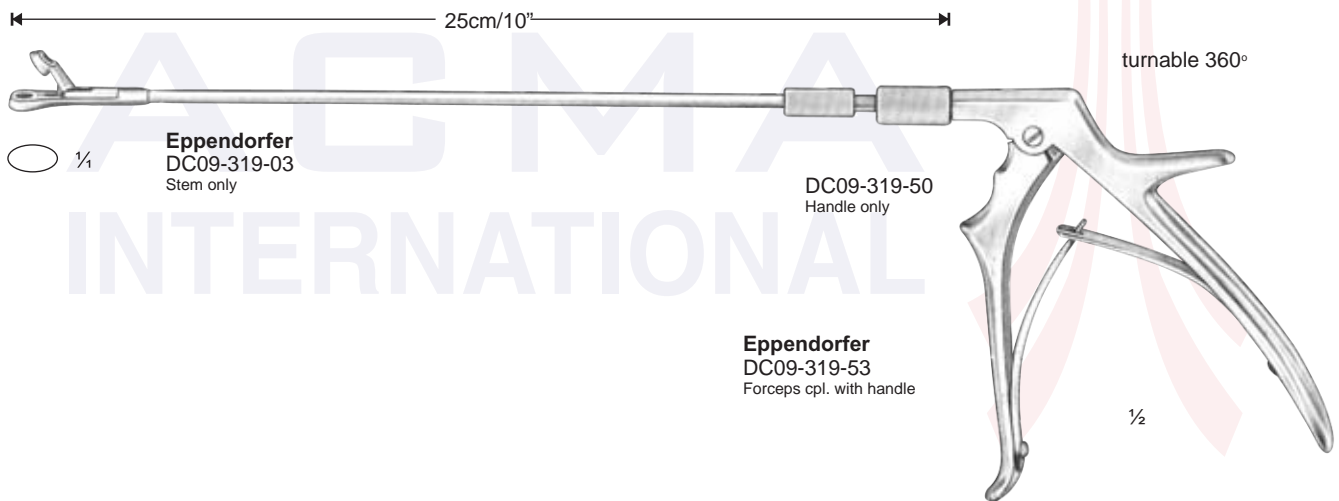
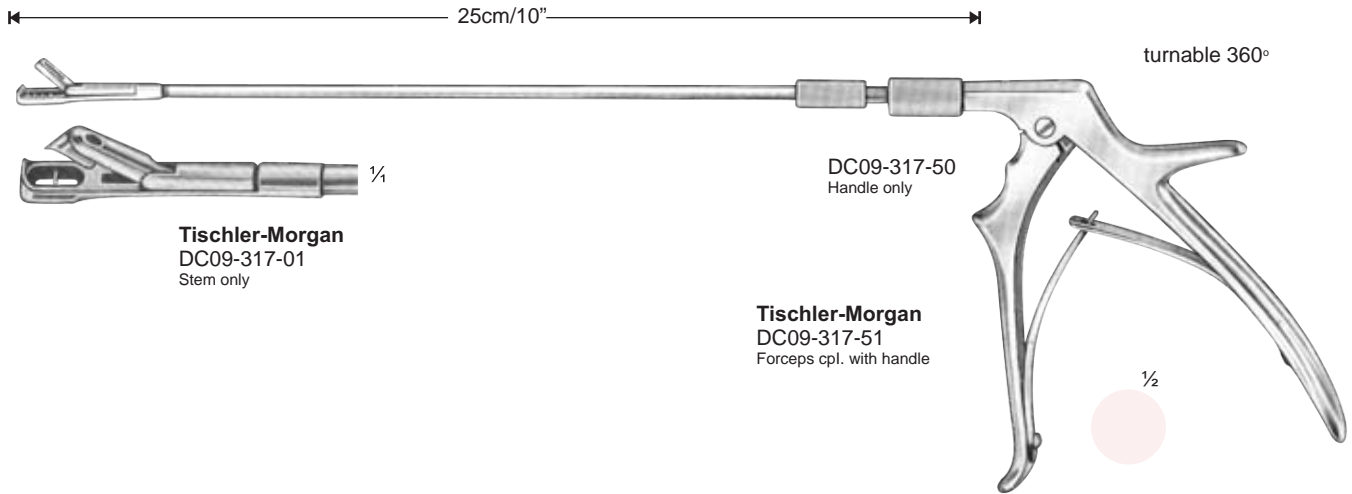

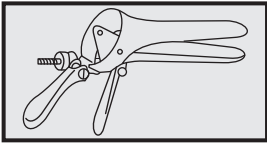

Cervical Biopsy and Specimen Forceps

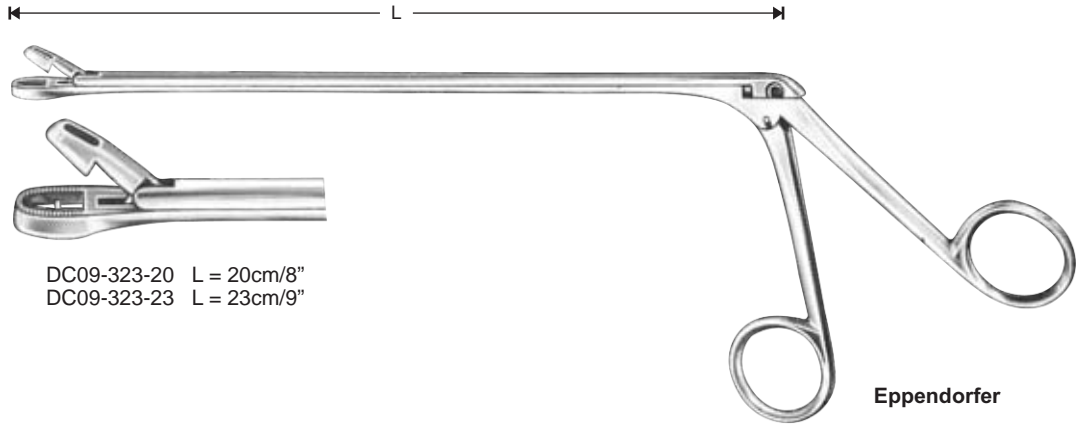

DC09-323-20 L = 20cm/8"
DC09-323-23 L = 23cm/9"

Eppendorfer

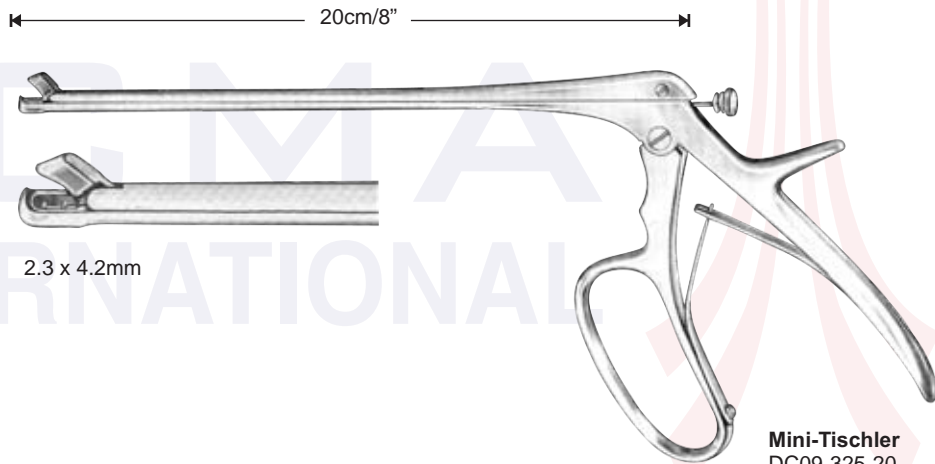

2.3 x 4.2mm

Mini-Tischler
DC09-325-20
(Townsend-Mini)

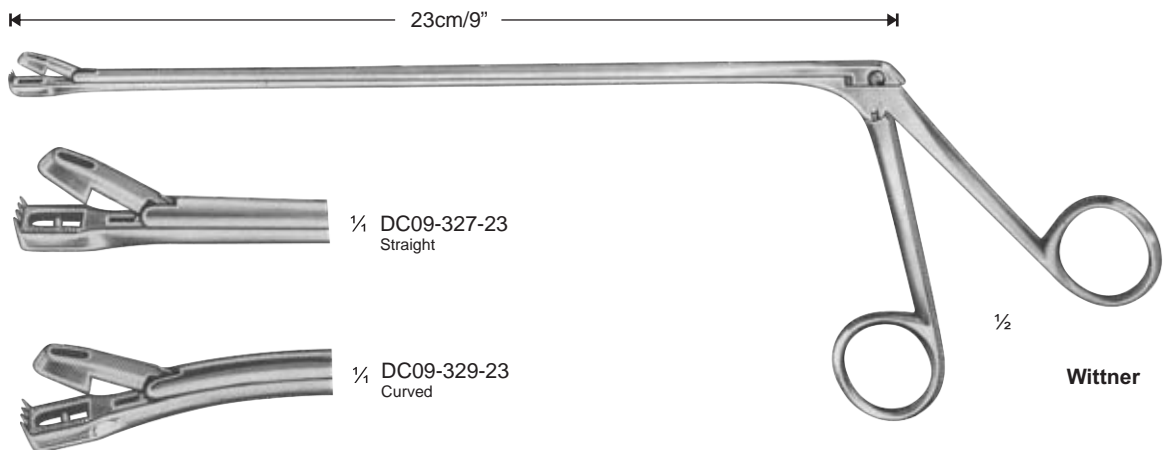

Wittner

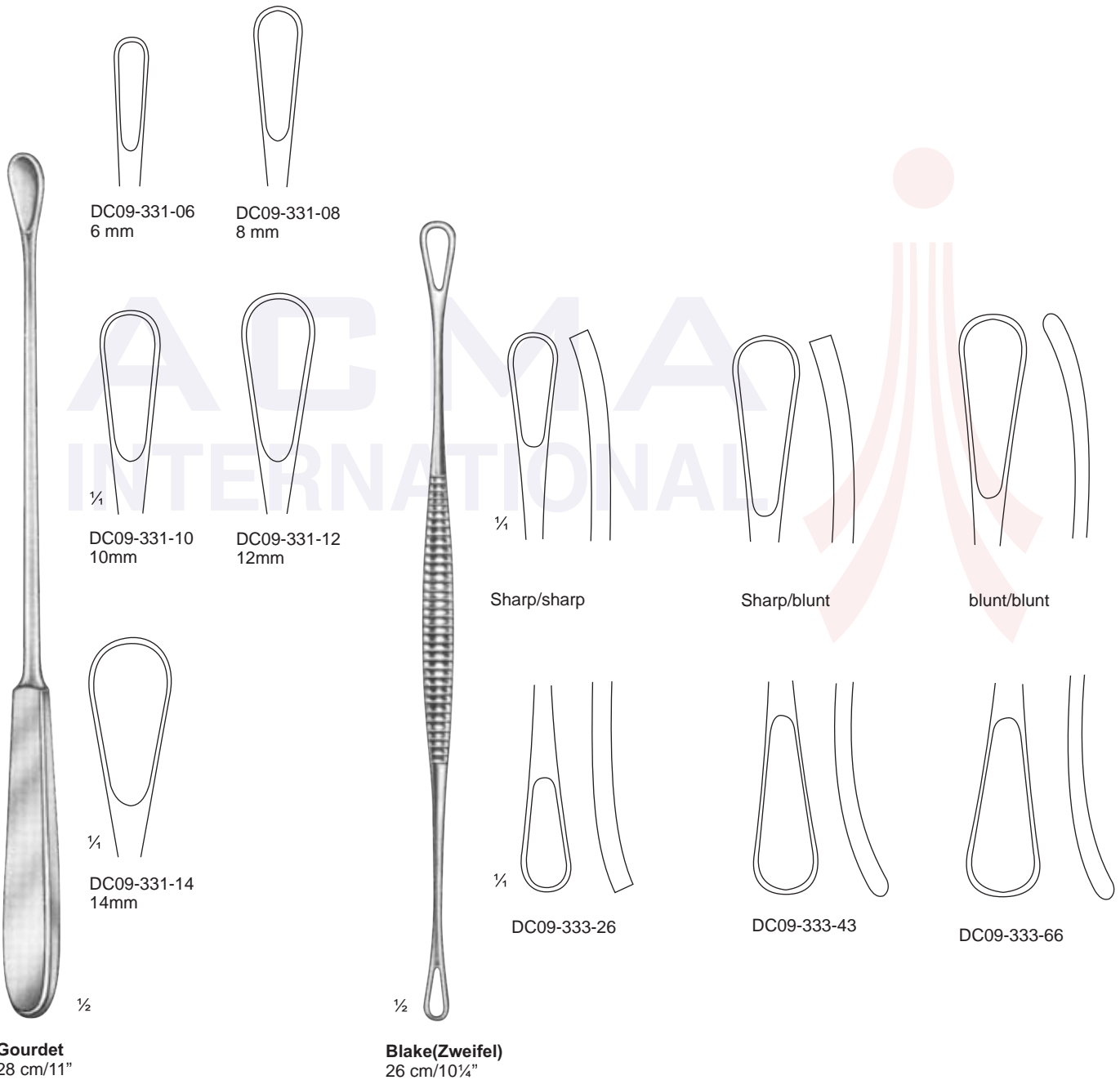
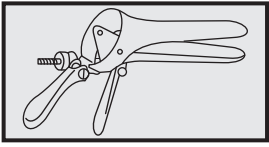

Uterine Curettes

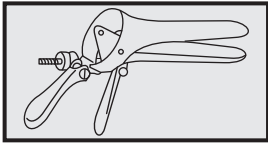

Recamier
max.31 cm/12½"

Sims
26 cm/10¼"

Sharp		blunt	
rigid	malleable	rigid	malleable
DC09-335-05	DC09-337-05	DC09-339-05	DC09-341-05
DC09-335-06	DC09-337-06	DC09-339-06	DC09-341-06
DC09-335-07	DC09-337-07	DC09-339-07	DC09-341-07
DC09-335-08	DC09-337-08	DC09-339-08	DC09-341-08
DC09-335-09	DC09-337-09	DC09-339-09	DC09-341-09
DC09-335-11	DC09-337-11	DC09-339-11	DC09-341-11
DC09-335-12	DC09-337-12	DC09-339-12	DC09-341-12
DC09-335-14	DC09-337-14	DC09-339-14	DC09-341-14
DC09-335-15	DC09-337-15	DC09-339-15	DC09-341-15
DC09-335-16	DC09-337-16	DC09-339-16	DC09-341-16
DC09-335-19	DC09-337-19	DC09-339-19	DC09-341-19
DC09-335-20	DC09-337-20	DC09-339-20	DC09-341-20

Sharp		blunt	
rigid	malleable	rigid	malleable
DC09-343-51	DC09-345-51	DC09-347-51	DC09-349-51
DC09-343-52	DC09-345-52	DC09-347-52	DC09-349-52
DC09-343-53	DC09-345-53	DC09-347-53	DC09-349-53
DC09-343-54	DC09-345-54	DC09-347-54	DC09-349-54
DC09-343-55	DC09-345-55	DC09-347-55	DC09-349-55
DC09-343-56	DC09-345-56	DC09-347-56	DC09-349-56

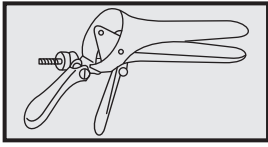

Simon
25 cm/10"

- Fig. sharp, rigid
- 1 DC09-351-01
 - 2 DC09-351-02
 - 3 DC09-351-03
 - 4 DC09-351-04
 - 5 DC09-351-05
 - 6 DC09-351-06

Schroeder
30 cm/12"

- Fig. sharp, rigid
- 1 DC09-353-01
 - 2 DC09-353-02
 - 3 DC09-353-03
 - 4 DC09-353-04
 - 5 DC09-353-05
 - 6 DC09-353-06

Blake
DC09-355-27
27 cm /10 1/2"
sharp/blunt

Bozemann-Fritsch
Uterine Douches
mm ø

- 8 DC09-357-08
- 10 DC09-357-10
- 12 DC09-357-12

Hildebrandt
DC09-359-21
21 cm /8 1/4"
Vaginal Irrigating
Cannula, of metal

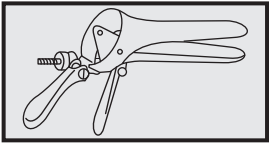

Aspirating Curettes

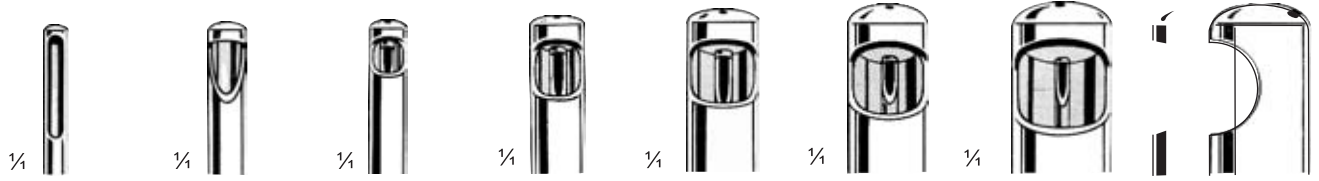

DC09-361-03
3 mm ø
Aspirating Curettes

DC09-361-04
4.5 mm ø
Aspirating Curettes

DC09-361-06
6 mm ø
Aspirating Curettes

DC09-361-08
8 mm ø
Aspirating Curettes

DC09-361-10
10 mm ø
Aspirating Curettes

DC09-361-12
12 mm ø
Aspirating Curettes

DC09-361-14
14 mm ø
Aspirating Curettes

DC09-361-50
Connecting Piece

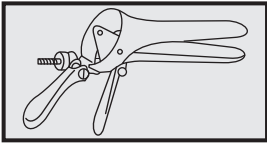

¼
Collin
DC09-363-35
35 cm /13 ¾"
cm scale



¼
Breisky
DC09-365-33
33 cm /13"
cm/inch scale



¼
Martin
DC09-367-34 cm scale
DC09-369-34 cm/inch scale
34 cm /13 ½"

for internal measurements



⅓
De Lee
DC09-371-20
20 cm /8"
cm/inch scale



¼
Collyer
DC09-373-30
30 cm /12"
cm/inch scale

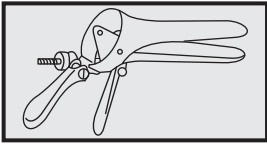

Obstetrical (Midwifery) Forceps



¼

De Lee
DC09-375-36
36 cm/14"



Elliot
DC09-377-32 = 32 cm/12 ½"
DC09-377-38 = 38 cm/15"



¼

Mc Lean
DC09-379-36
36 cm/14"

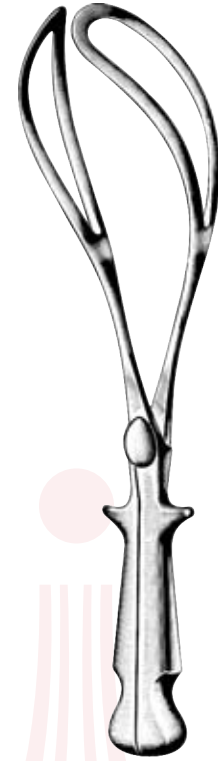

Naegele
DC09-381-36 = 36 cm/14"
DC09-381-40 = 40 cm/16"



¼

Simpson
DC09-383-30
30 cm/12"



¼

Simpson-Braun
DC09-385-36
36 cm/14"



¼

Simpson-Luikart
DC09-387-36
36 cm/14"



¼

De Lee
DC09-389-30
30 cm/12"

Obstetrical (Midwifery) Forceps

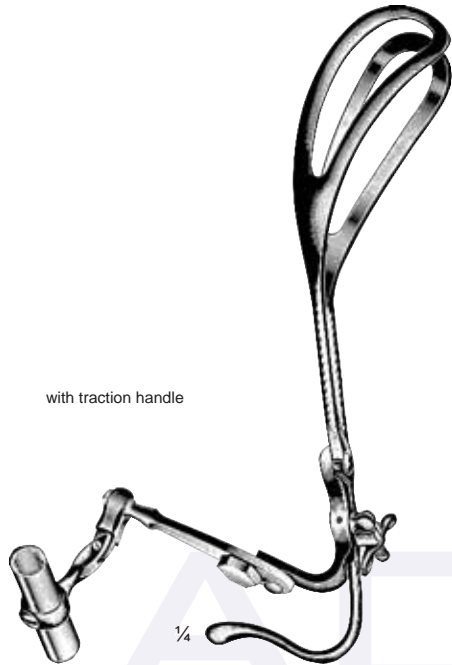
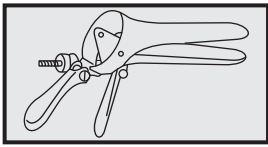

with traction handle

Dewey
DC09-391-37
37 cm/14 1/2"

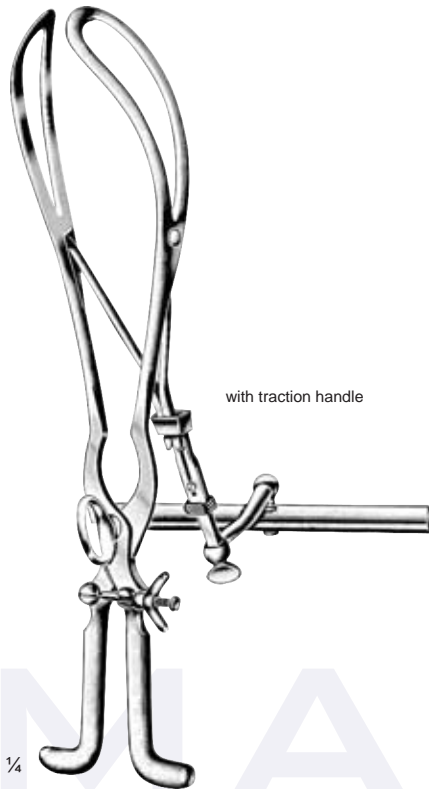

with traction handle

Tarnier
DC09-393-40
40 cm/15 3/4"



with traction handle

Piper
DC09-395-40
40 cm/15 3/4"



1/4

Hirst
DC09-397-26
26 cm/10 1/4"

1/4

Barton
DC09-399-36
36 cm/14"

Traction Handle for
obstetrical forceps
DC09-399-36



1/4

Barton
DC09-401-17
17 cm/6 3/4"

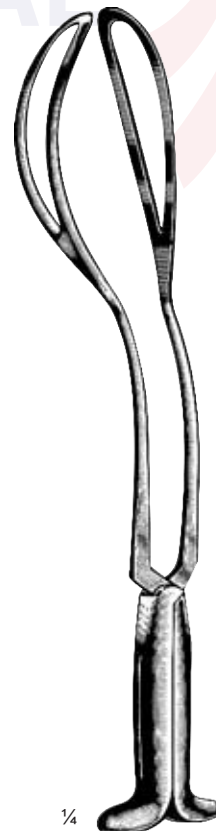

specifically for
obstetrics in breech
presentation

1/4

Piper
DC09-403-44
44 cm/17 1/4"

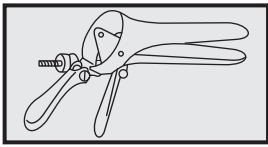

Obstetrical (Midwifery) Forceps



Kielland
DC09-405-41
41 cm/16"



Kielland-Luikart
DC09-407-40
40 cm/15 3/4"



Luikart
DC09-409-40
40 cm/15 3/4"



Mc Lean-Tucker
DC09-411-39
39 cm/15 1/2"



Mc Lean-Luikart
DC09-413-39
39 cm/15 1/2"

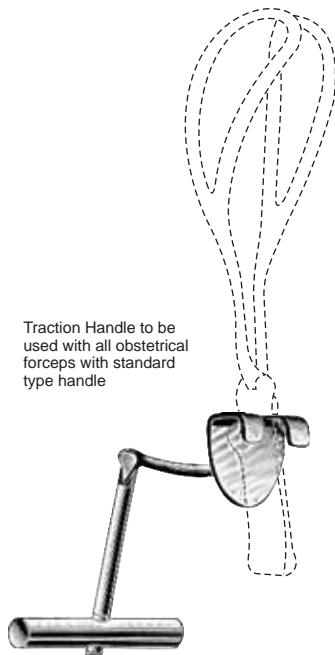

Traction Handle to be used with all obstetrical forceps with standard type handle

Traction Handle for obstetrical forceps
DC09-405-41 - DC09-409-40



Luikart-Bill
DC09-417-21
21 cm/8 1/4"

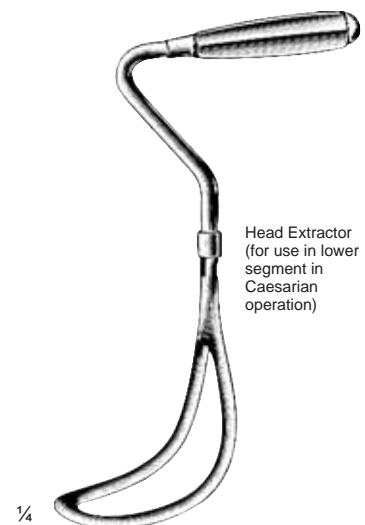

Head Extractor
(for use in lower segment in Caesarian operation)

Murless
DC09-419-26
26 cm/10 1/4"

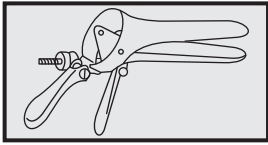

Placenta and Ovum Forceps, Scalp Flap Forceps, Elevating Spoon, etc.

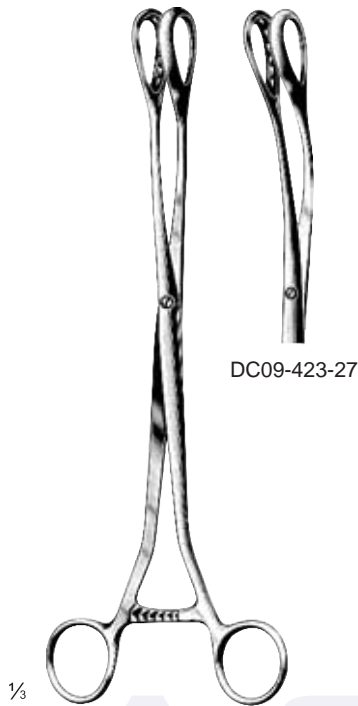

Saenger
DC09-421-27
27 cm/10 1/2"

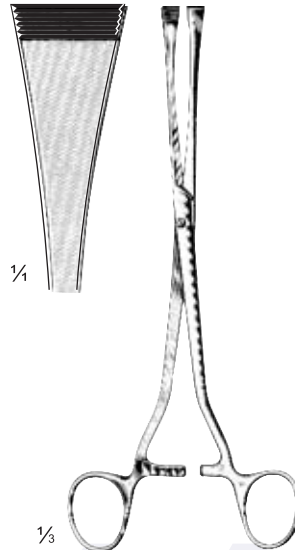

Green-Armytage
DC09-425-21
21 cm/8 1/4"
Uterine Haemostasis Forceps,
for use in lower segment in
Caesarian operation



Sellheim
DC09-427-28
28 cm/11"
Elevating Spoon,
for movement of the head

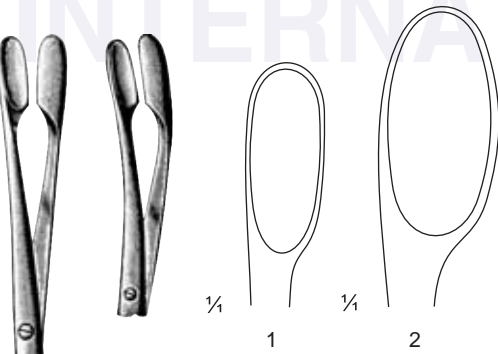

straight	Fig.	curved
DC09-429-01	1	DC09-431-01
DC09-429-02	2	DC09-431-02

Winter
28 cm/11"

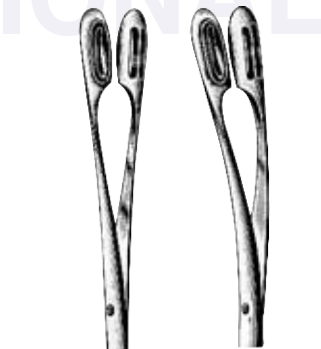

Kranz
DC09-433-29
29 cm/11 1/2"

The holding part has been shifted to the inside of the blades. The uterine mucosa will therefore not be gripped by the edge of the jaws.

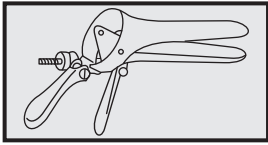

Placenta and Ovum Forceps, Abortion Scoops

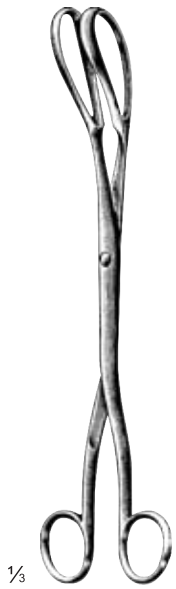

$\frac{1}{3}$
Corey (Greenhalg)
 DC09-437-24
 24 cm/9 $\frac{1}{2}$ "

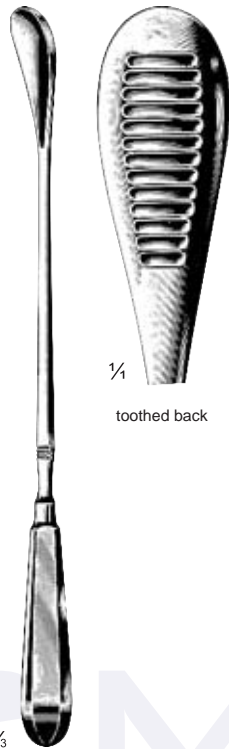

$\frac{1}{3}$
Cuzzi
 30 cm/12"

$\frac{1}{4}$
 toothed back

14 $\frac{1}{2}$ mm



DC09-439-01

18 mm

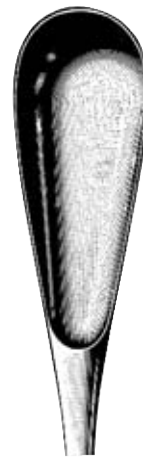

DC09-439-02

21 mm



DC09-439-03



$\frac{1}{3}$
Naegele
 DC09-441-25
 25 cm/10"
 Perforators

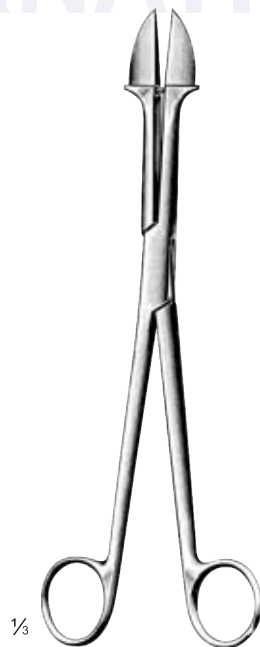

$\frac{1}{3}$
Smellie
 DC09-443-25
 25 cm/10"

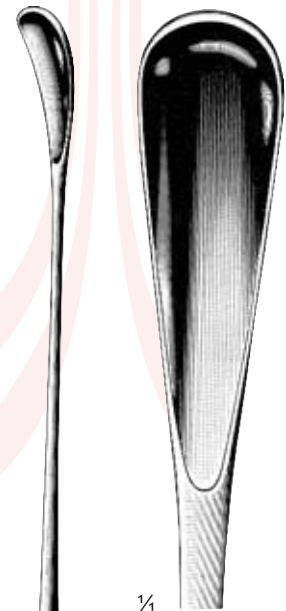

$\frac{1}{4}$
 DC09-445-02
 blunt
 Placenta and Abortion Scoops

$\frac{1}{3}$
Wallich
 42 cm/16 $\frac{1}{2}$ "

ACMA
 INTERNATIONAL

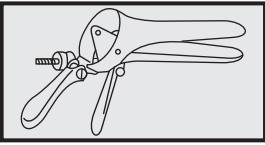

Ovum Curettes, Obstetrical Hooks, Basiotribe
Cranioclast, Umbilical Cord clamps



1/2
Kane
DC09-447-08
8.5 cm/3 1/2"
Umbilical Cord Clamps



1/2
Collin
DC09-449-09
9 cm/3 1/2"
Umbilical Cord Clamps

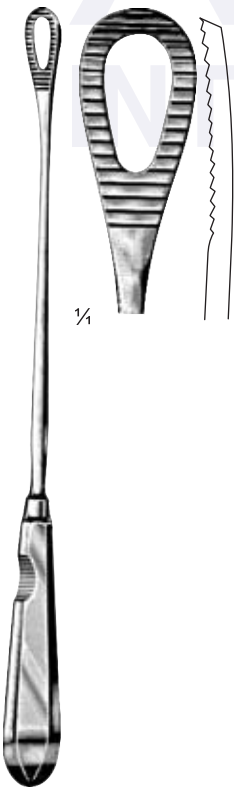

1/3
Pestalozza
DC09-451-30
30 cm/12"



1/4
Braun
DC09-453-30
30 cm/12"
Decapitating Hook

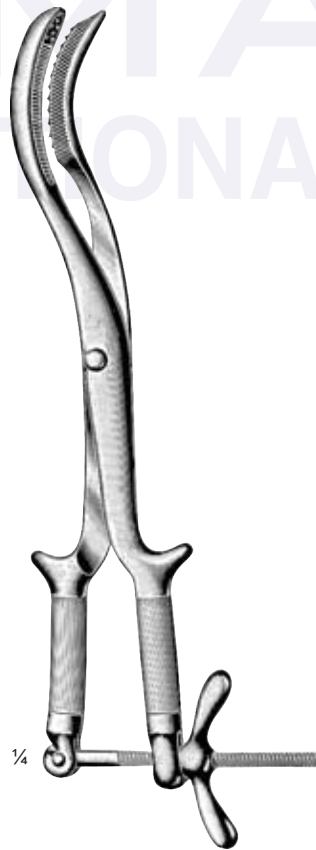

1/4
Braun
DC09-455-42
42 cm/16 1/2"
Cranioclast

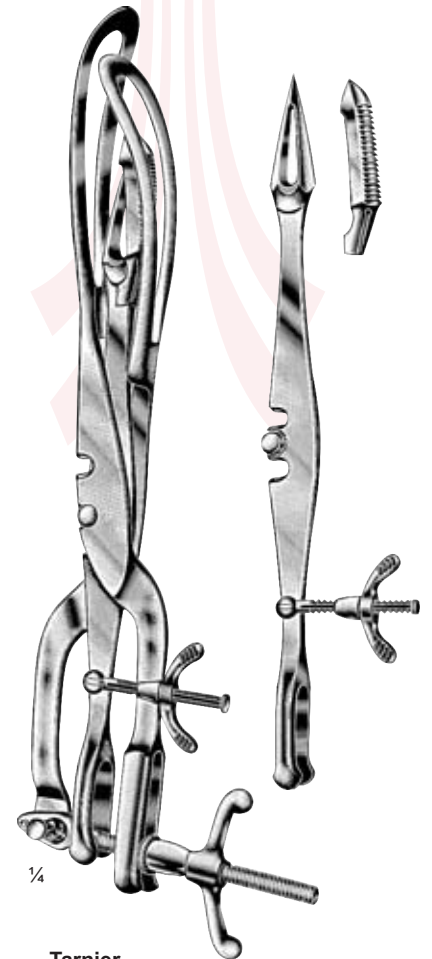

1/4
Tarnier
DC09-457-46
46 cm/18"
Basiotribe