

16

Kidney, Liver, Gall, Urology

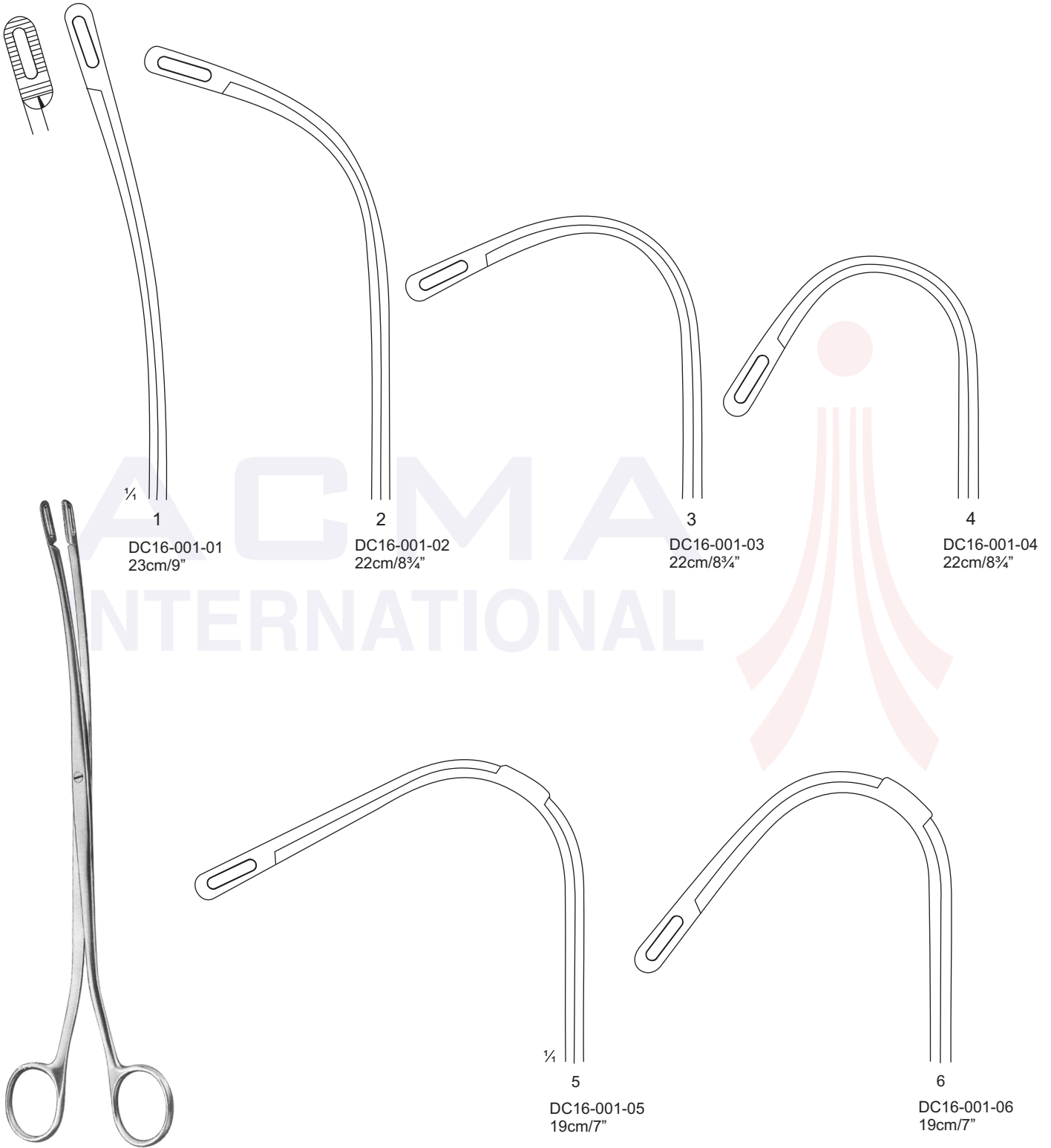

Kidney Stone Forceps

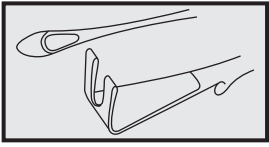

Randall

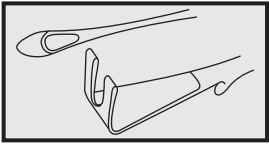

DeBakey
DC16-003-20
20cm/8"

Cooley
DC16-005-18
18.5cm/7¼"

Cooley
DC16-005-19
19.5cm/7¾"

Renal Artery Clamps- also used for subclavin and carotid artery

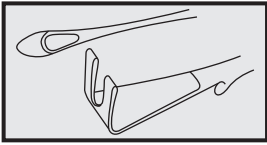

Kidney Pedicle Clamp Forceps

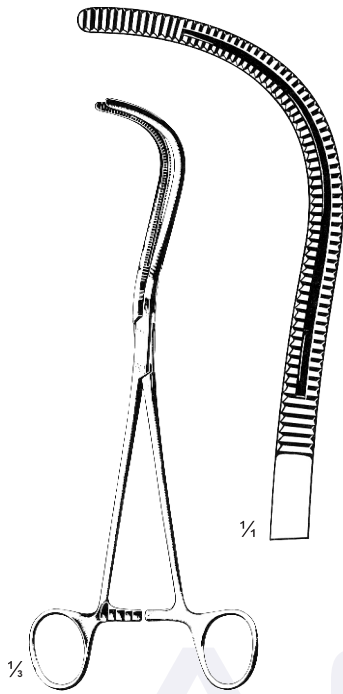

Stille
DC16-007-22
22cm/8 3/4"

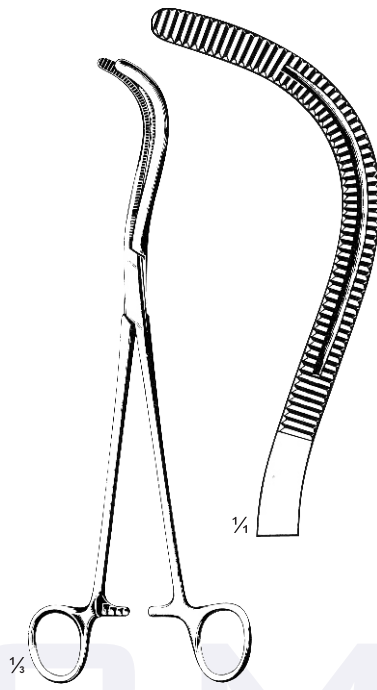

Stille
DC16-009-24
24cm/9 1/2"

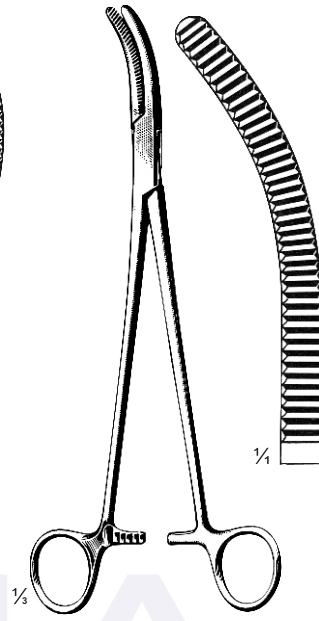

Wertheim
DC16-011-25
25cm/10"



Herrick
DC16-013-23
23cm/9"

ACMA INTERNATIONAL



Pean

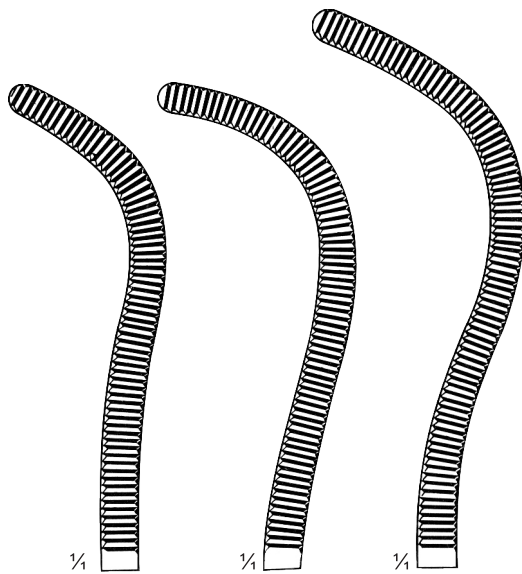

DC16-015-20
20cm/8"

DC16-015-22
22cm/8 3/4"

DC16-015-24
24cm/9 1/2"

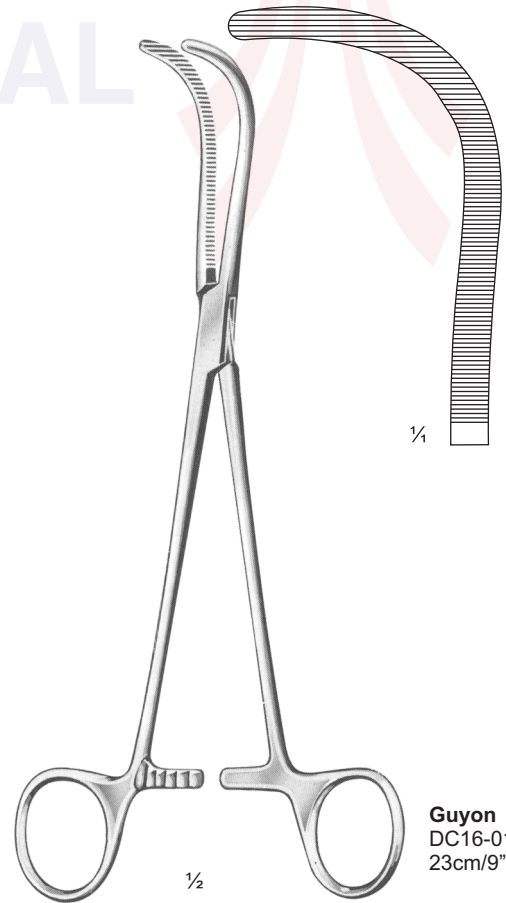

Guyon
DC16-017-23
23cm/9"

Gall Stone Forceps

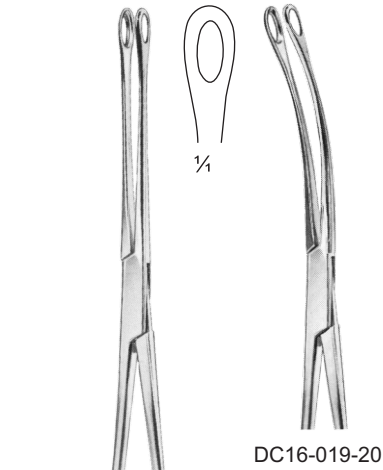
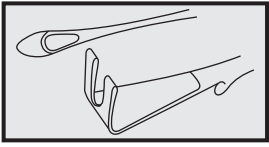

DC16-019-20

Blake
DC16-021-20
20 cm / 8"



Mayo-Blake
DC16-023-20
20 cm / 8"



Mayo-Blake
DC16-025-20
20 cm / 8"

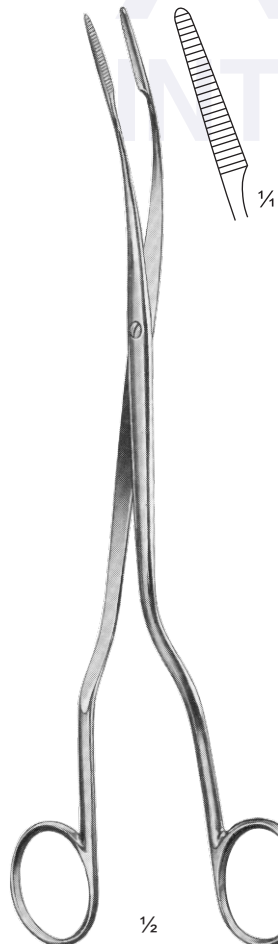

Czerny
DC16-027-25
24.5 cm / 9 3/4"

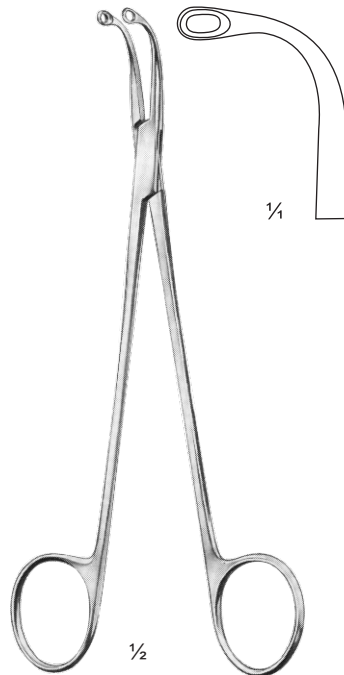

Turner-Warwick
DC16-029-18
18 cm / 7"

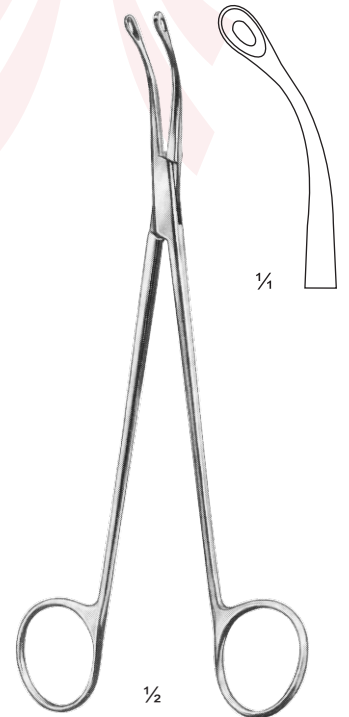

Turner-Warwick
DC16-031-19
19 cm / 7 1/2"

Gall Stone Forceps, Gall Duct- and Cystic Forceps

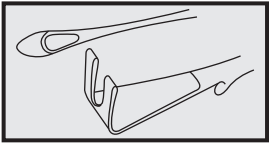

Mixer
DC16-033-22
22 cm / 8 3/4"

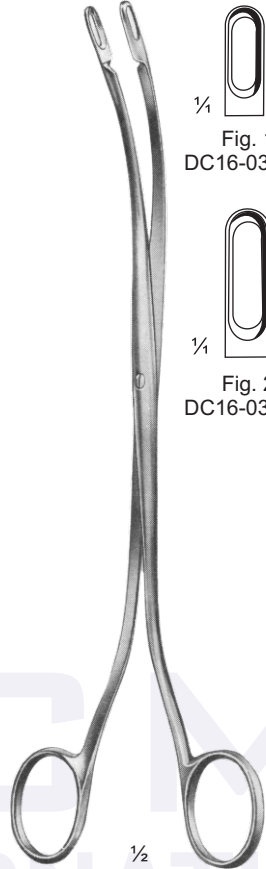

Desjardins
23 cm / 9"

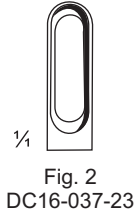
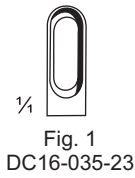

Desjardins
DC16-039-21
21cm/8 1/4"

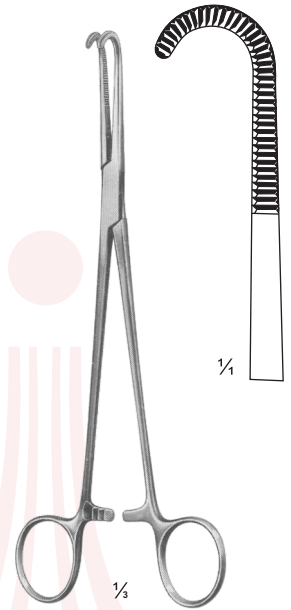

Nissen
DC16-041-22
22.5cm/9"

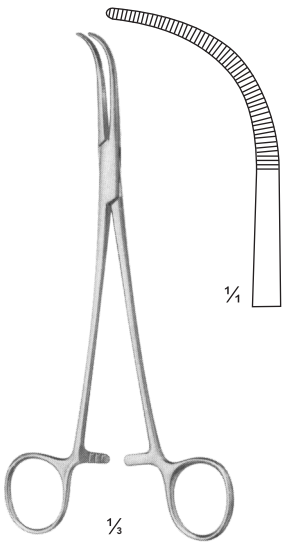

Green
DC16-043-20
20cm/8"



Gray

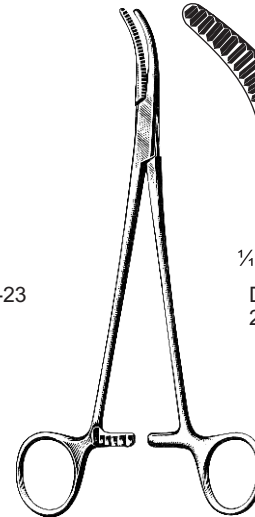
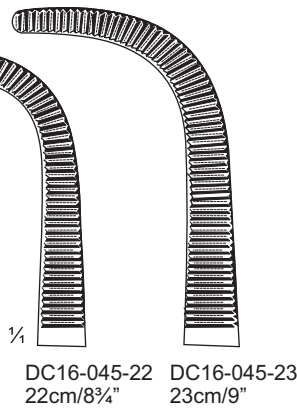

Moynihan

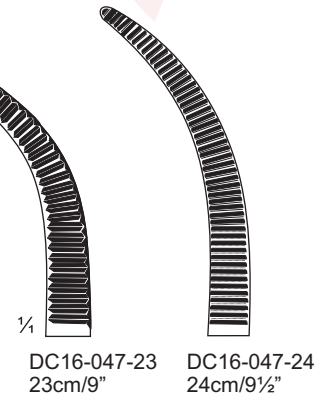

Gall Stone Probes, Gall Duct Dilators

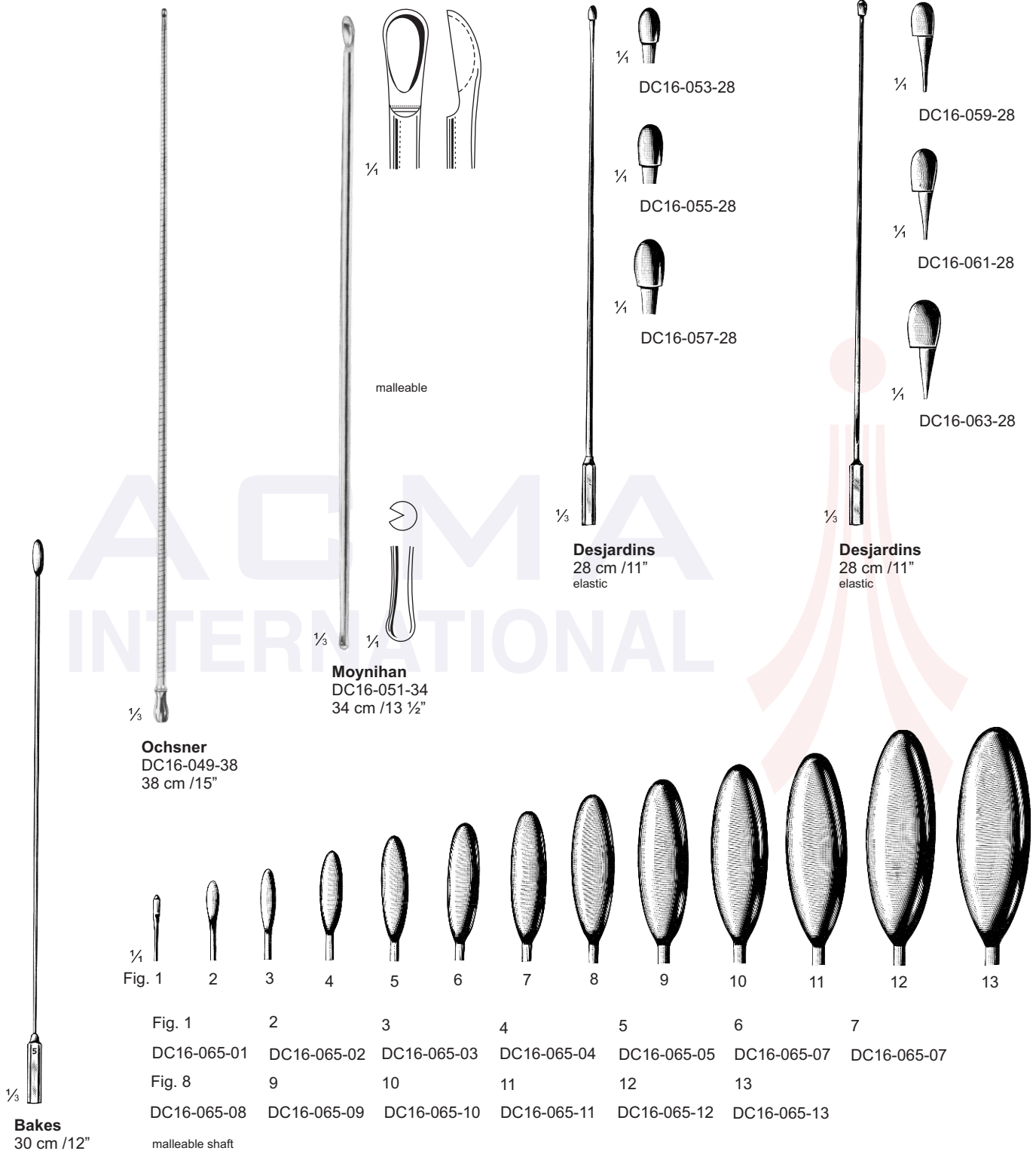
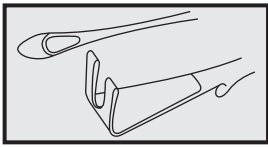

- DC16-049-38 - Gall Duct Probe, with stilette, malleable
- DC16-053-28 - DC16-057-28 - with eccentric olives
- DC16-059-28 - DC16-063-28 - Gall Stone Probes, elastic
- DC16-065-01 - DC16-065-13 - Gall Duct Dilators, Copper shaft, malleable

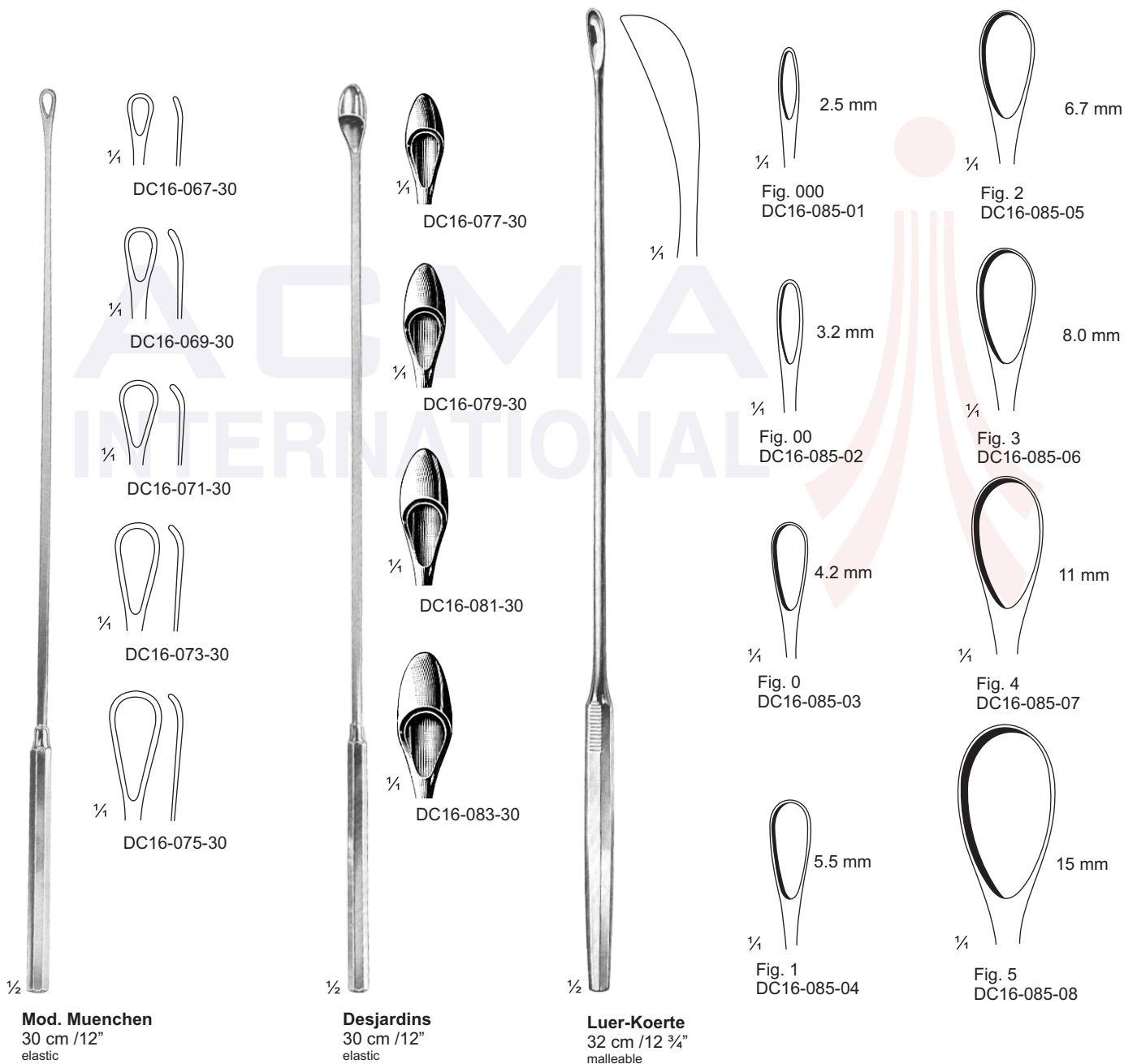
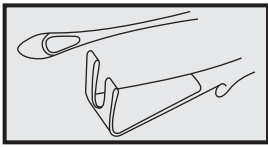

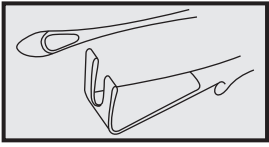

¼

Fergusson
DC16-087-21
21.5 cm / 8 ½"

¼

Fergusson
DC16-087-22
22 cm / 8 ¾"

¼

Fergusson
DC16-087-23
23.5 cm / 9 ¼"

½

Mayo
DC16-089-27
28 cm / 11"

½

DC16-091-34
34 cm / 12 ½"

½

Moore
DC16-093-28
28 cm / 11"

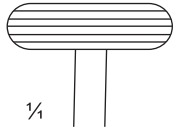
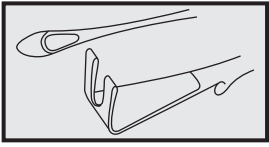

1/4



1/2

Millin
DC16-099-23
23 cm / 9"
prostatic Lobe Holding Forceps,
for anterior lobes, 9:9 teeth



1/2

Millin
DC16-101-24
24 cm / 9 1/2"
Ligature Carrying Forceps



1/2

DC16-095-16
16 cm / 6 1/4"
Spermatic Cord Hook, blunt

Millin
DC16-097-23
23 cm / 9"
Capsule Forceps,
for retropubic prostatectomy

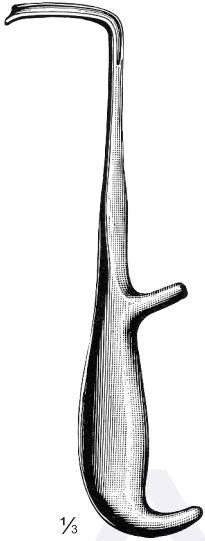
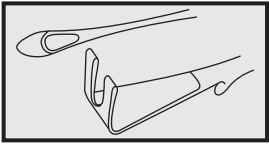

1/3

Young
DC16-103-21
21 cm / 8 1/4"

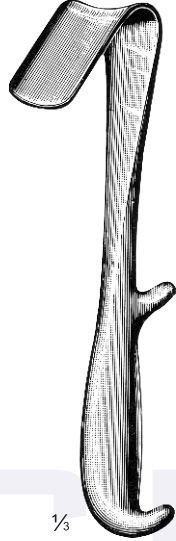

1/3

Young
DC16-105-22
22 cm / 8 3/4"

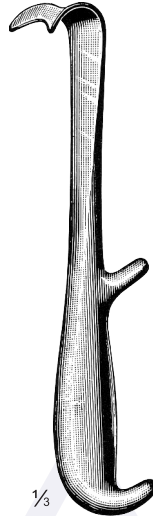

1/3

Young
DC16-107-21
21 cm / 8 1/4"
for bulb

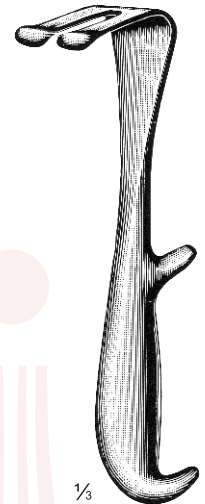

1/3

Young
DC16-109-22
22 cm / 8 3/4"

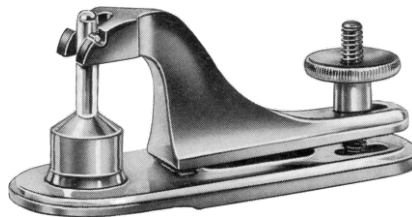

Circumcision Instrument
DC16-111-08 - DC16-111-32

- DC16-111-08 - 8 mm ø, baby size
- DC16-111-11 - 11 mm ø, child size
- DC16-111-13 - 13 mm ø, child size
- DC16-111-16 - 16 mm ø, adolescent size
- DC16-111-21 - 21 mm ø, adolescent size
- DC16-111-26 - 26 mm ø, men's size
- DC16-111-32 - 32 mm ø, men's size

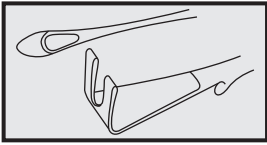

Dilating Bougies, Set of Dilating Sounds



Dittel
6-10 mm
18-30 Charriere

Dittel
Charriere (French)
No. 8-30

Van Buren
Charriere (French)
No. 8-36

Guyon
Charriere
No. 10-30

Guyon
Charriere
No. 10-30

Filiform
31-610-12

Set	DC16-115-00	DC16-117-00	DC16-119-00	DC16-121-00
single	DC16-113-00	DC16-115-08 - 31-680-30	DC16-117-08 - 31-699-36	DC16-119-10 - DC16-119-30
				DC16-121-00 - DC16-121-30
		Scale mm Ø	I	II
				Dittel
				Van Buren curved
				Guyon without int. thread
				Guyon with int. thread
		2	8	DC16-115-08
		3	9	DC16-115-09
		3	10	20
		3	11	22
		4	12	24
		4	13	26
		4	14	28
		4	15	30
		5	16	32
		5	17	34
		6	18	36
		6	19	38
		6	20	40
		7	21	42
		7	22	44
		7	23	46
		8	24	48
		8	25	50
		8	26	52
		9	27	54
		9	28	56
		9	29	58
		10	30	60
		10	32	
		10	34	
		10	36	
				DC16-117-08
				DC16-117-10
				DC16-117-12
				DC16-117-14
				DC16-117-16
				DC16-117-18
				DC16-117-20
				DC16-117-22
				DC16-117-24
				DC16-117-26
				DC16-117-28
				DC16-117-30
				DC16-117-32
				DC16-117-34
				DC16-117-36
				DC16-119-10
				DC16-119-11
				DC16-119-12
				DC16-119-13
				DC16-119-14
				DC16-119-15
				DC16-119-16
				DC16-119-17
				DC16-119-18
				DC16-119-19
				DC16-119-20
				DC16-119-21
				DC16-119-22
				DC16-119-23
				DC16-119-24
				DC16-119-25
				DC16-119-26
				DC16-119-27
				DC16-119-28
				DC16-119-29
				DC16-119-30
				DC16-121-10
				DC16-121-11
				DC16-121-12
				DC16-121-13
				DC16-121-14
				DC16-121-15
				DC16-121-16
				DC16-121-17
				DC16-121-18
				DC16-121-19
				DC16-121-20
				DC16-121-21
				DC16-121-22
				DC16-121-23
				DC16-121-24
				DC16-121-25
				DC16-121-26
				DC16-121-27
				DC16-121-28
				DC16-121-29
				DC16-121-30

Scale I
Charriere (French) No. 8-36
rising by mm per number

Scale II
Benique No. 20-26, rising
by mm per two numbers

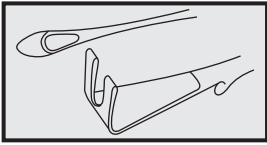

Metal Catheters

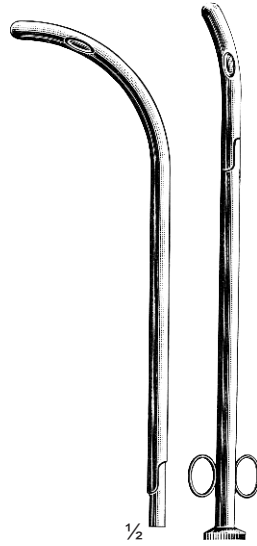

DC16-123-00
male and female

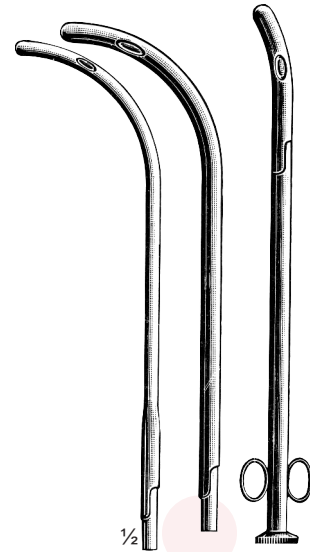

DC16-125-00
male, female and
for children

Table of measurements

Scale mm ø	Charriere (French)		
2	6	DC16-127-06	DC16-129-06
2 1/3	7	DC16-127-07	DC16-129-07
2 2/3	8	DC16-127-08	DC16-129-08
3	9	DC16-127-09	DC16-129-09
3 1/3	10	DC16-127-10	DC16-129-10
3 2/3	11	DC16-127-12	DC16-129-12
4	12	DC16-127-13	DC16-129-13
4 1/3	13	DC16-127-14	DC16-129-14
4 2/3	14	DC16-127-15	DC16-129-15
5	15	DC16-127-16	DC16-129-16
5 1/3	16	DC16-127-17	DC16-129-17
5 2/3	17	DC16-127-18	DC16-129-18
6	18	DC16-127-19	DC16-129-19
6 1/3	19	DC16-127-20	DC16-129-20
6 2/3	20	DC16-127-21	DC16-129-21
7	21	DC16-127-22	DC16-129-22
7 1/3	22	DC16-127-23	DC16-129-23
7 2/3	23	DC16-127-24	DC16-129-24
8	24		



DC16-127-06 - DC16-127-24
Charriere (French) No. 6-24
27 cm / 10 1/2"
Male Catheters



DC16-129-06 - DC16-129-24
Charriere (French) No. 6-24
15 cm / 6"
Female Catheters Combined,
for pocket sets

Foreign Body Forceps, Meatotome
Secretion Scoops, penis Seizing Forceps, Meatus Clamps

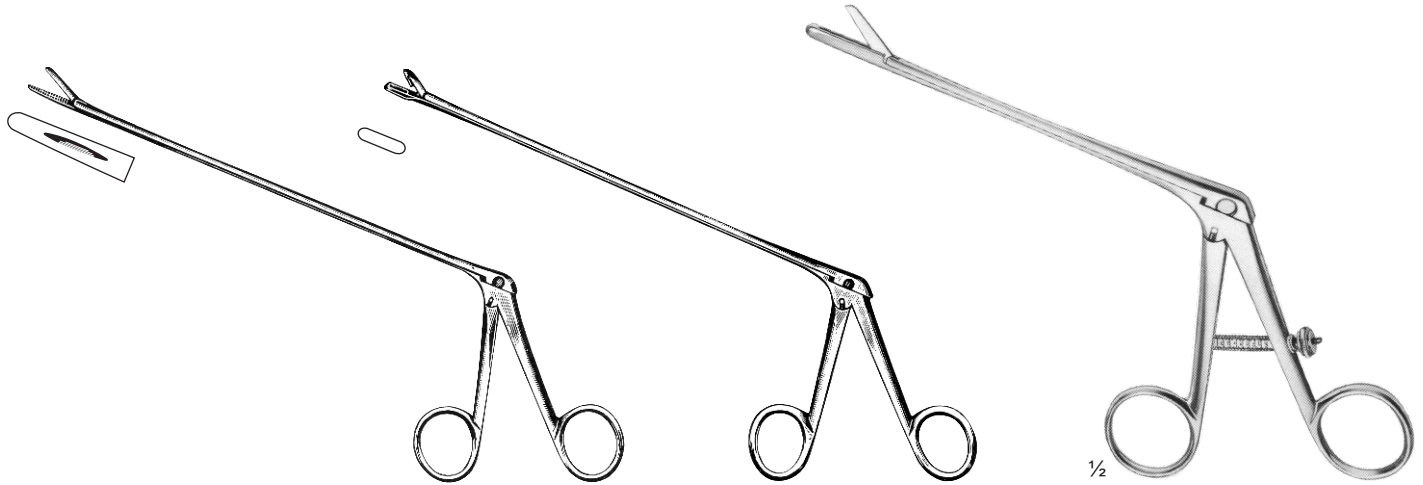
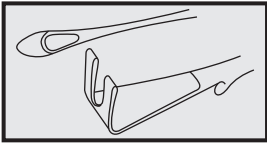

Lengths of shanks

Mathieu
DC16-131-20 = 20 cm/8"
DC16-131-28 = 28 cm/11"
Urethral Foreign Body Forceps, serrated jaws

Mathieu
DC16-133-20 = 20 cm/8"
DC16-133-28 = 28 cm/11"
Urethral Foreign Body Forceps, serrated jaws
sharp, punch jaws

Sachse
DC16-135-12
Meatotome

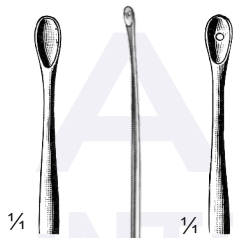

1/4

1/4

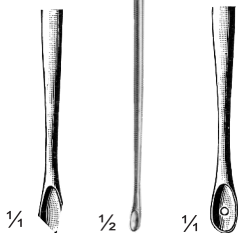

1/4

1/2

1/4

Guttman
DC16-137-26
Secretion Scoops flexible,
may be held in the open flame,
without holes
DC16-139-26
with holes
26.5 cm / 10 1/2"



1/2

Jusbasic
DC16-141-19
19 cm / 7 1/2"
Penis Seizing Forceps

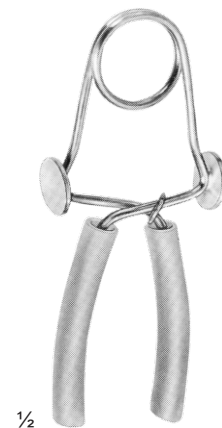
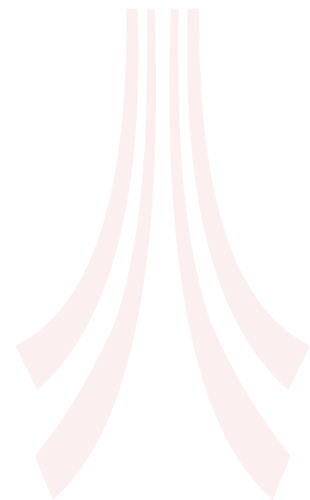

1/2

Strauss
DC16-143-11
Meatus Clamp, rubber covered

Bladder Retractors

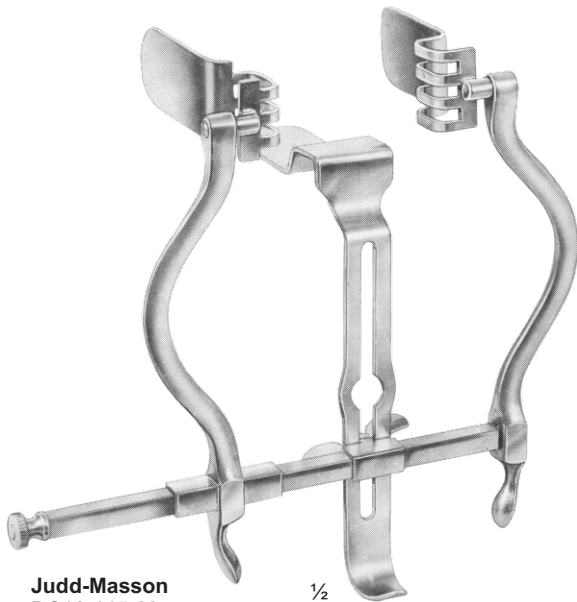
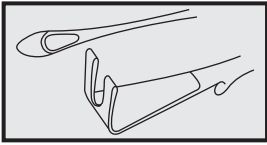

Judd-Masson
DC16-145-00

1/2

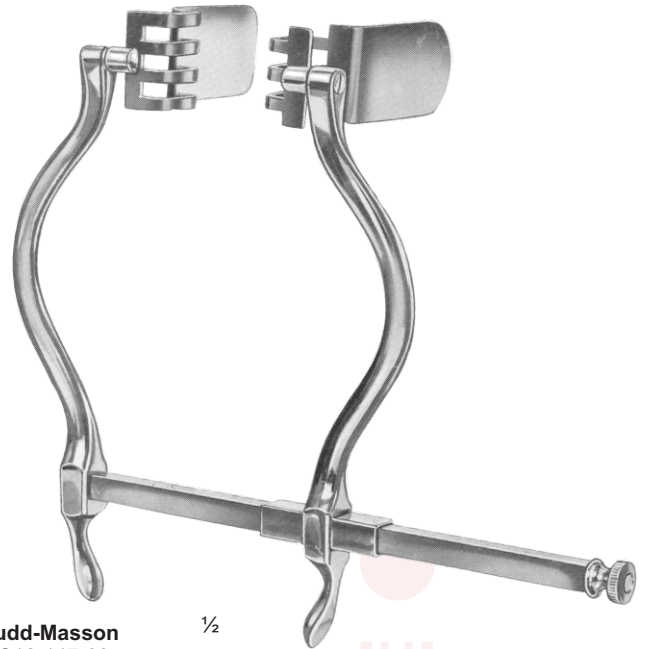

Judd-Masson
DC16-147-00

1/2



Thomson-Walker
DC16-149-00

1/2

1/2



Legueu
DC16-151-00

1/2

- DC16-147-00 - for supra pubic prostatectomy, with 2 swivel blades
- DC16-149-00 - self-retaining, with 4 detachable blades, center spatula and retractor
- DC16-151-00 - with 2 detachable blades and center spatula

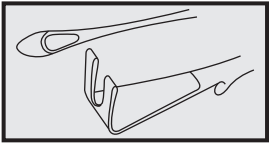

35 mm

1/2

Legueu
DC16-153-27
27 cm / 10 1/2"



56 mm

1/2

Kocher
DC16-155-26
26 cm / 10 1/4"



67 mm

1/2

Kocher
DC16-157-26
26 cm / 10 1/4"

ACMA
INTERNATIONAL



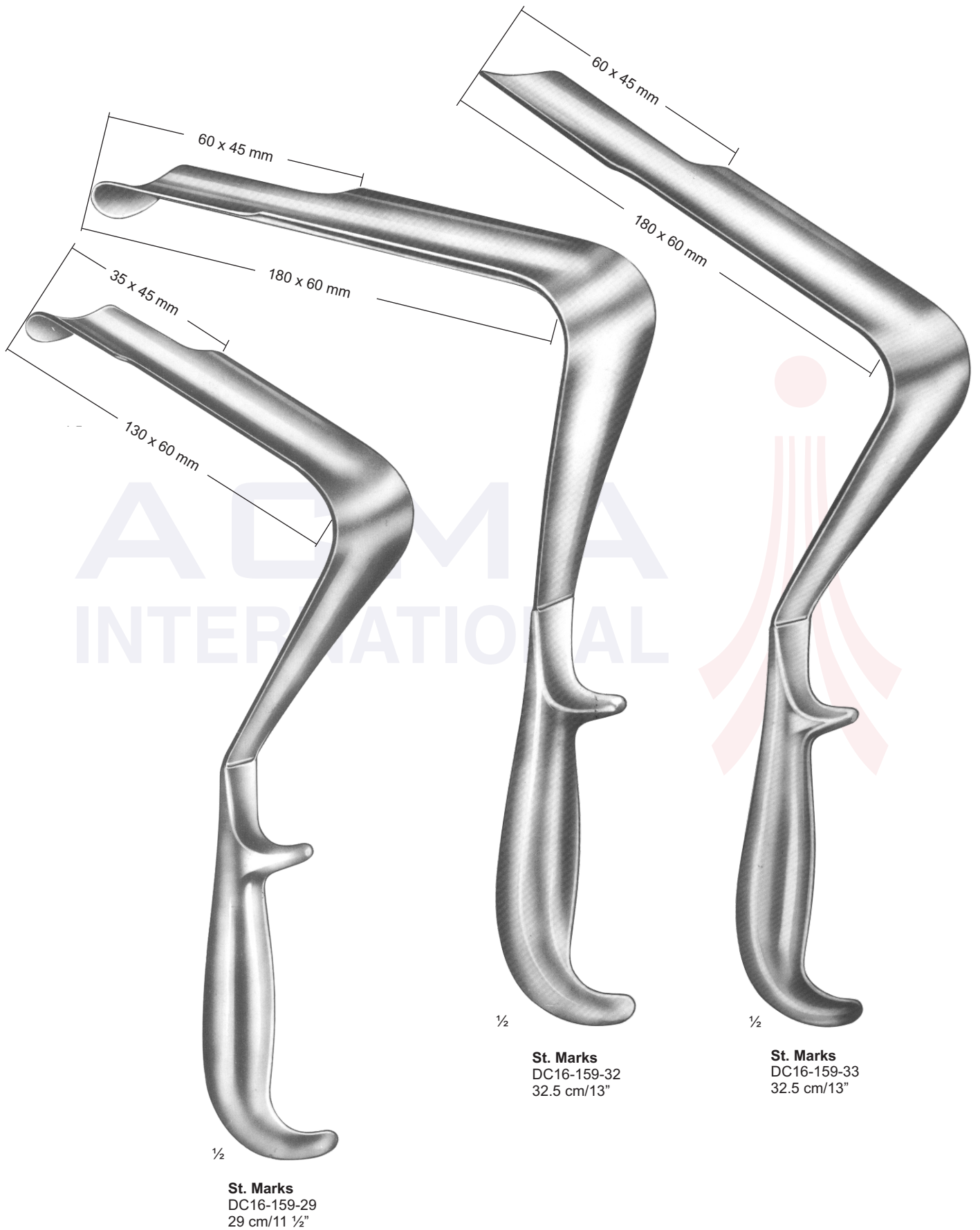
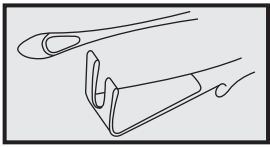

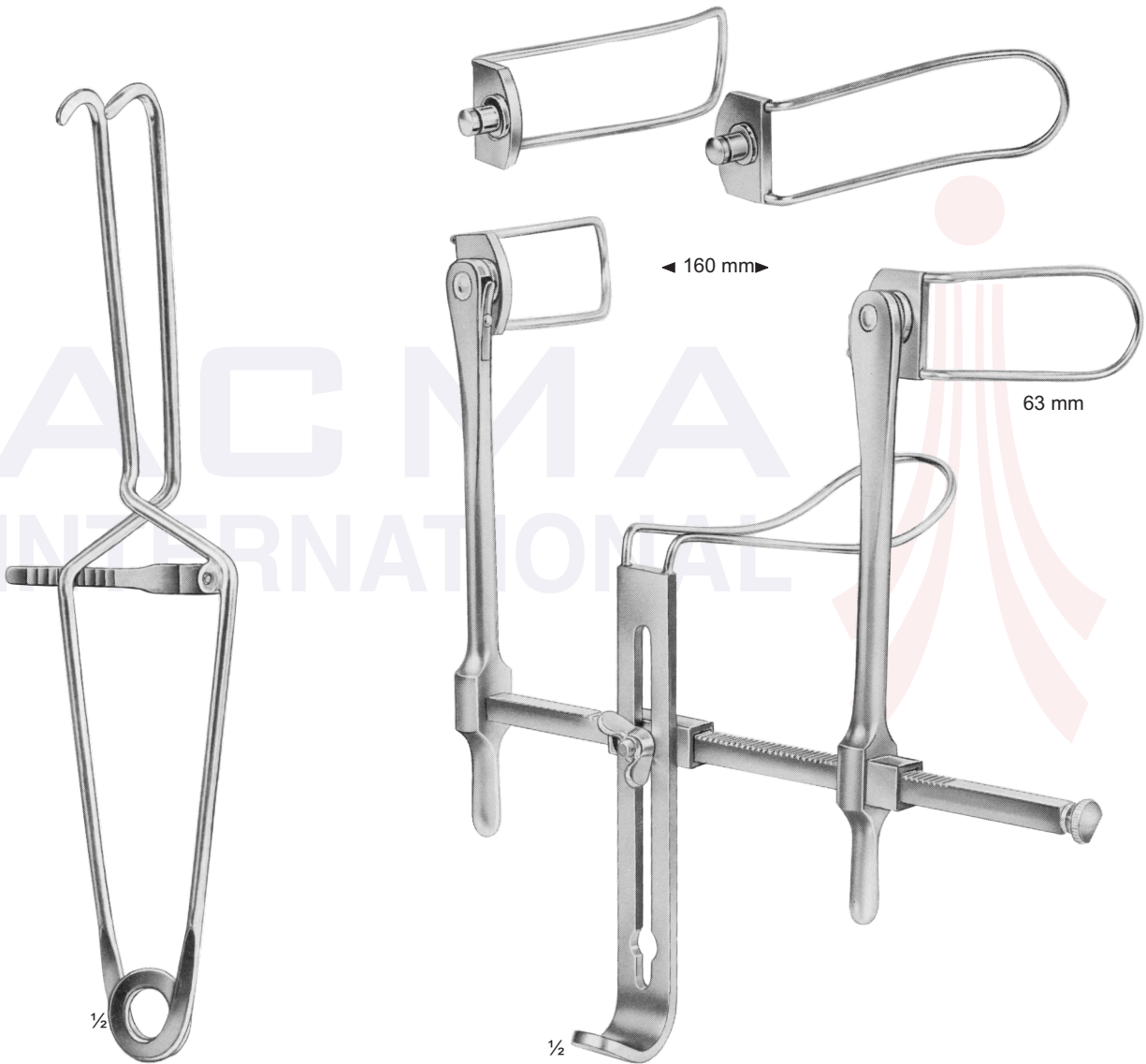
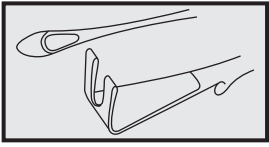

Millin
DC16-161-00
Meatus Clamp
(Bladder Neck Spreader)

Gosset
DC16-163-00
Bladder Retractor