

17

Ophthalmology

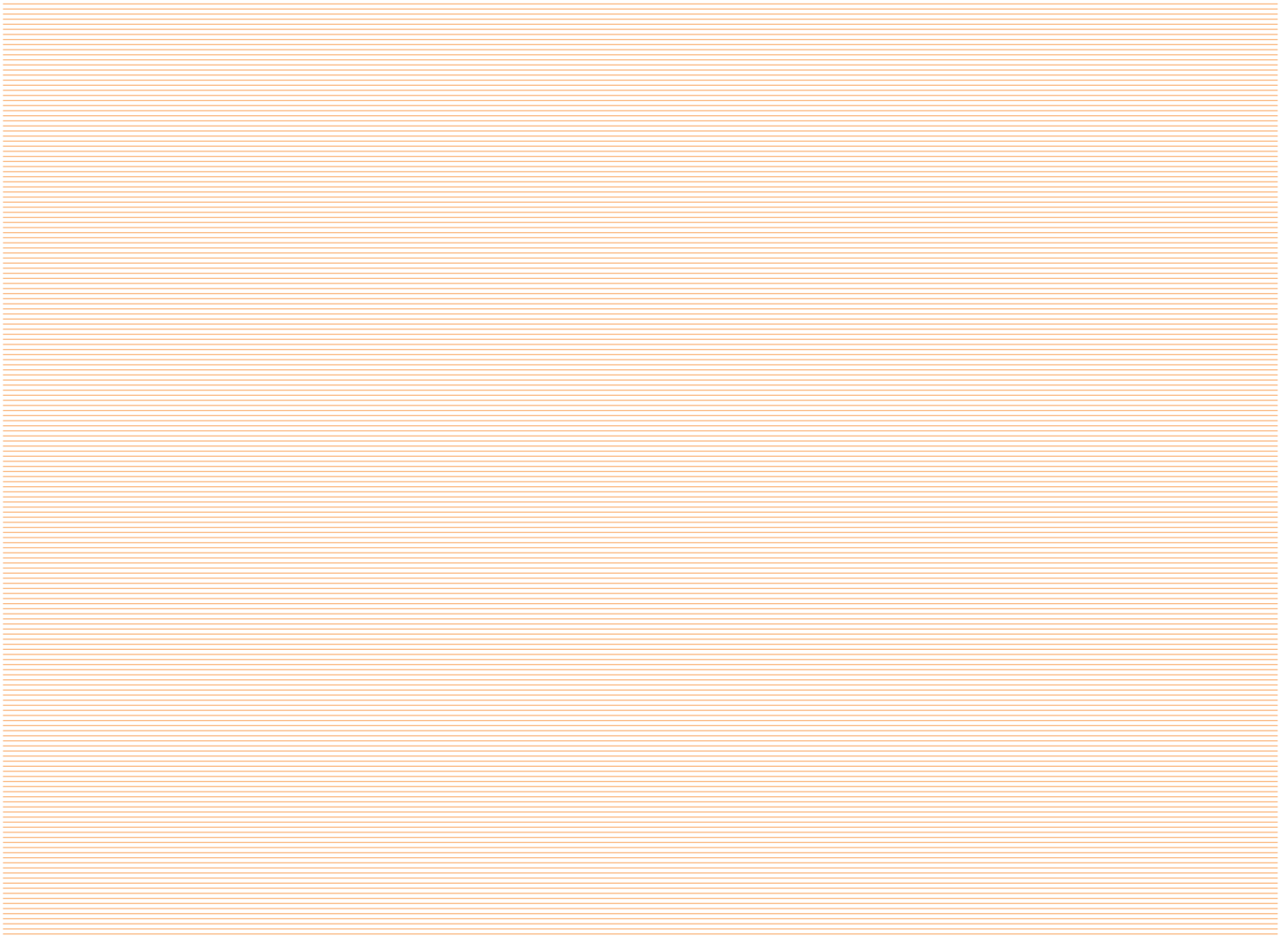

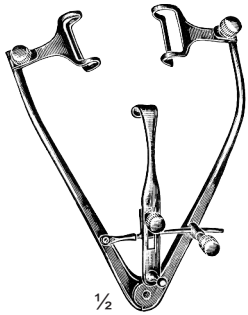
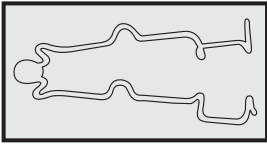

1/2

Park
DC17-001-08
8 cm/3 1/4"

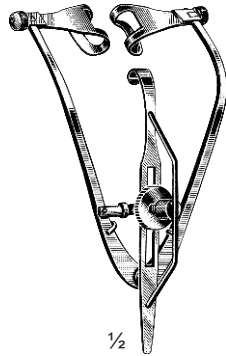

1/2

Park-Guyton
DC17-003-08
8 cm/3 1/4"

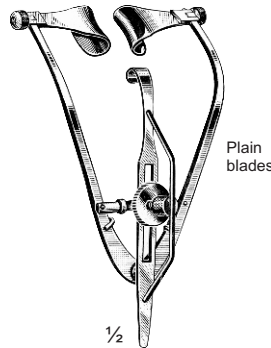

1/2

Park-Maumenee
DC17-005-08
8 cm/3 1/4"

Plain blades

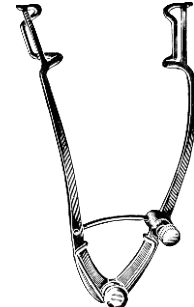

Williams
DC17-007-07 = 7 cm/2 3/4"
children
DC17-007-08 = 8 cm/3 1/4"
adults



Weiss
DC17-009-07 = 7 cm/2 " children
DC17-009-09 = 9 cm/3 1/2" adults

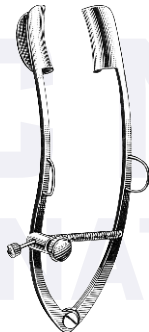

Weiss
DC17-011-07 = 7 cm/2 " children
DC17-011-09 = 9 cm/3 1/2" adults



1/2

Weiss
DC17-013-08
8 cm/3 1/4"

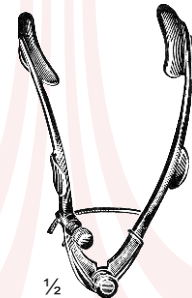

1/2

Lister-Burch
DC17-015-08
8 cm/3 1/4"

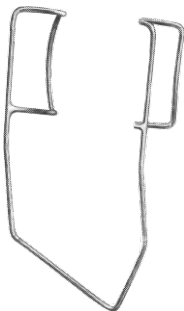

Barraquer (Colibri)
DC17-017-03 = 3 cm/1 1/4" children
DC17-017-04 = 4 cm/1 1/2" adults

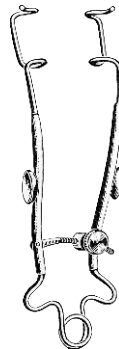

Graefe
DC17-019-06 = 7 cm/2 3/4" children
DC17-019-09 = 9 cm/3 1/2" adults

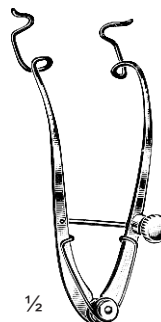

1/2

Knapp-Clark
DC17-021-08
8 cm/3 1/4"

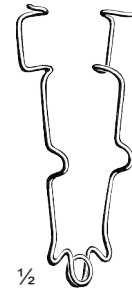

1/2

Bowman
DC17-023-07
7 cm/2 3/4"

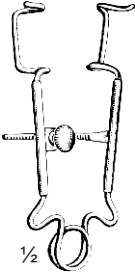
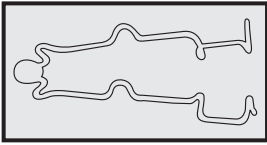

Critchett
DC17-025-06
7 cm / 2 3/4"

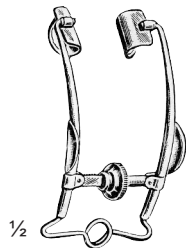

Pley
DC17-027-06
6 cm / 2 1/2"

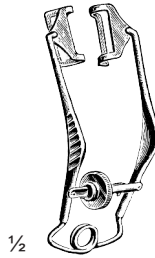

Ziegler
DC17-029-07
7 cm / 2 3/4"

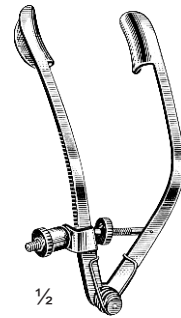

Lancaster
DC17-031-07
8 cm / 3 1/4"

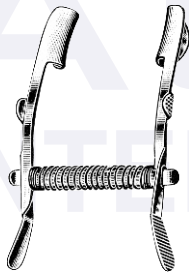

Mellinger Beard
DC17-033-05 = 5 cm / 2"
children
DC17-033-07 = 7 cm / 2 3/4"
adults



Sauer
DC17-035-03
3 cm / 1 1/4"



Castroviejo
DC17-037-08
8 cm / 3 1/4"



Stevenson
DC17-039-07
7 cm / 2 3/4"



Mueller
DC17-041-07
7 cm / 2 3/4"



Agricola
DC17-043-04
4 cm / 1 1/2"

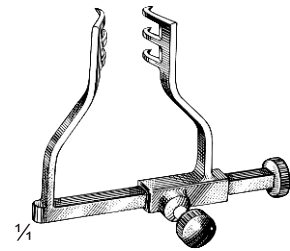

Goldstein
DC17-045-03
3 cm / 1 1/4"

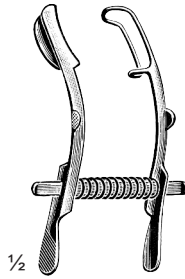
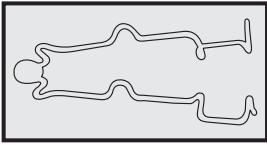

Mellinger-Axenfeld
DC17-047-07
7 cm/2 3/4"

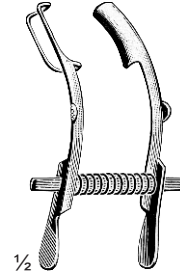

Mellinger-Axenfeld
DC17-049-07
7 cm/2 3/4"

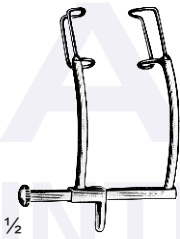

Murdock
DC17-051-05
5 cm/2"

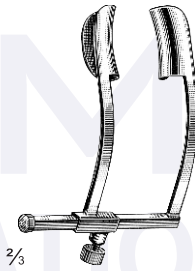

Cook
DC17-053-04 = 4 cm/1 1/2"
children
DC17-053-05 = 5 cm/2"
adults

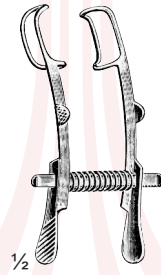

Mellinger
DC17-055-05 = 5 cm/2"
children
DC17-055-07 = 7 cm/2 3/4"
adults

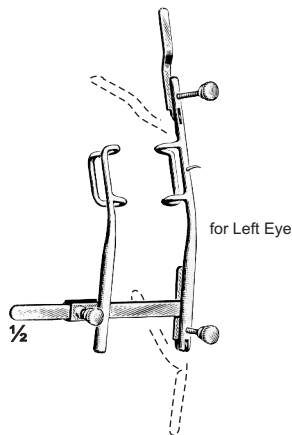

Arruga
DC17-057-07
7 cm/2 3/4"

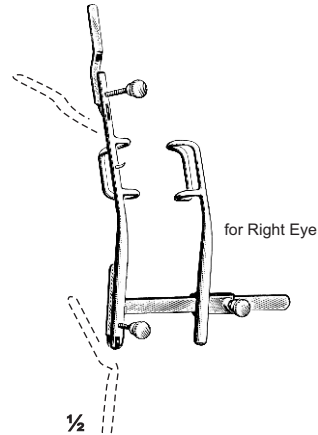

Arruga
DC17-059-07
7 cm/2 3/4"

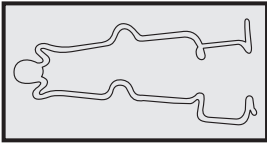

Castroviejo-Barraquer
Cyclodialysis Spatula



Castroviejo-Barraquer
Cyclodialysis Spatula

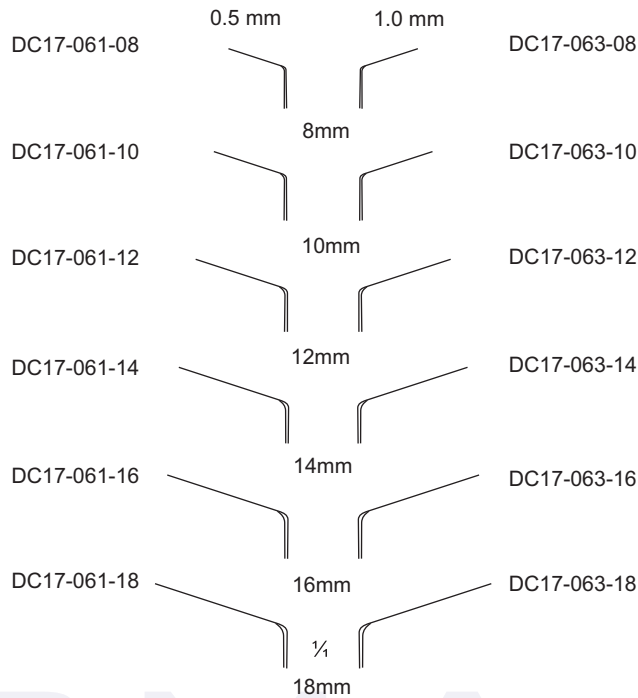

Various Spatulas



Cyclodialysis Spatulas

1.2 x 12 mm



Elschnig
DC17-065-13
13 cm/5"

1.2 x 10 mm



Castroviejo
DC17-067-10
13 cm/5"

1.5 x 15 mm

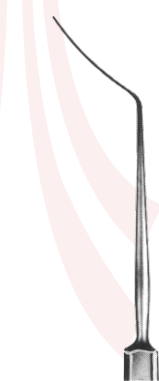

Castroviejo
DC17-069-15
14 cm/5½"

Width of spatula

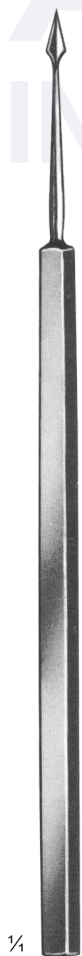

¼

Iris Spatulas



Wecker
DC17-071-13
13 cm/5"

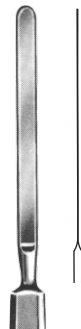

Wecker
DC17-073-13
13 cm/5"



Stock
DC17-075-13
13 cm/5"

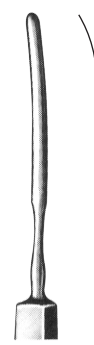

Culler
DC17-077-13
13 cm/5"



Suker
DC17-079-14
14 cm/5½"

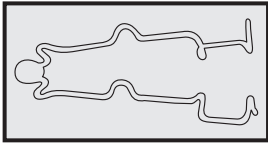

Lid Instruments, Bi-Prong-Marker, Muscle Hook



$\frac{1}{2}$
Siniscal-Smith
 DC17-081-11
 11 cm / 4 $\frac{1}{2}$ "

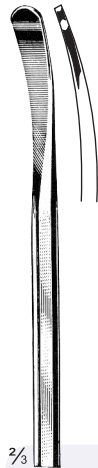

$\frac{2}{3}$
Schepens
 DC17-085-13
 13 cm / 5"

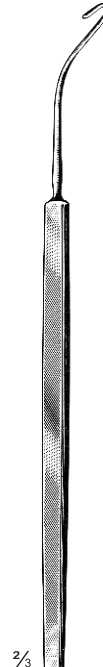

$\frac{2}{3}$
Scobee
 DC17-087-13
 13 cm / 5"



$\frac{2}{3}$
Conway
 DC17-089-13
 13 cm / 5"



$\frac{2}{3}$
Desmarres
 DC17-091-13
 13 cm / 5"

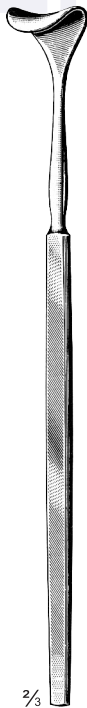

$\frac{2}{3}$
Desmarres
 13 cm / 5"



12 mm
 DC17-093-13

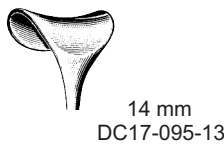

14 mm
 DC17-095-13



16 mm
 DC17-097-13

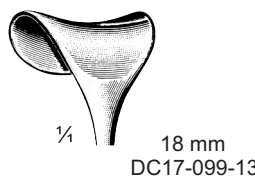

$\frac{1}{4}$
 18 mm
 DC17-099-13



$\frac{2}{3}$
Desmarres
 13 cm / 5"



12 mm
 DC17-101-13



14 mm
 DC17-103-13



16 mm
 DC17-105-13



$\frac{1}{4}$
 18 mm
 DC17-107-13

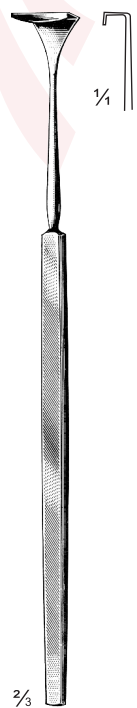

$\frac{2}{3}$
Groenholm
 DC17-109-13
 13 cm / 5"

Double-ended Instruments, Trephines, Markers, Spatulas, etc.

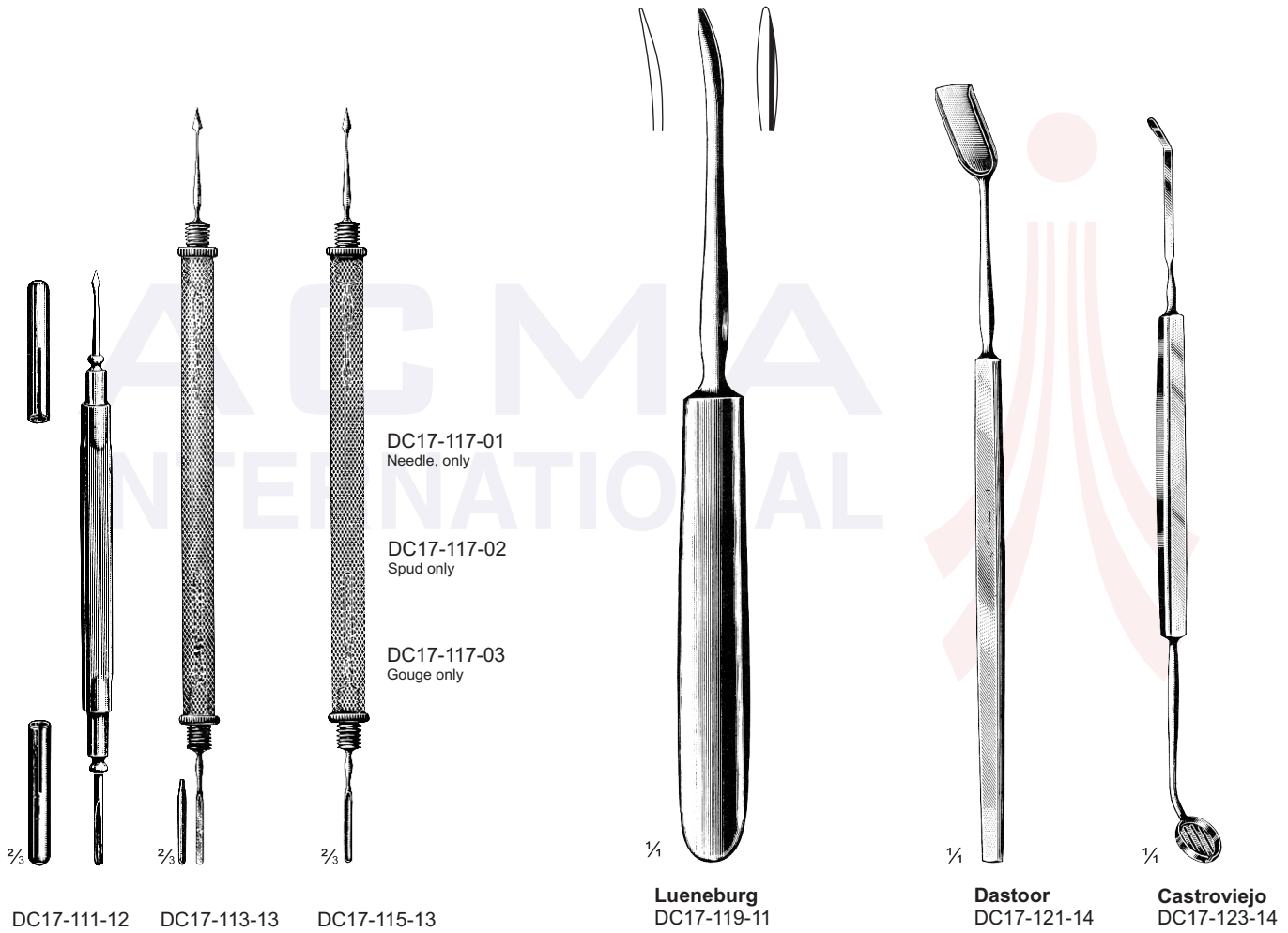
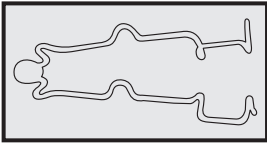

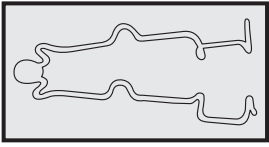

Trabecular Probes

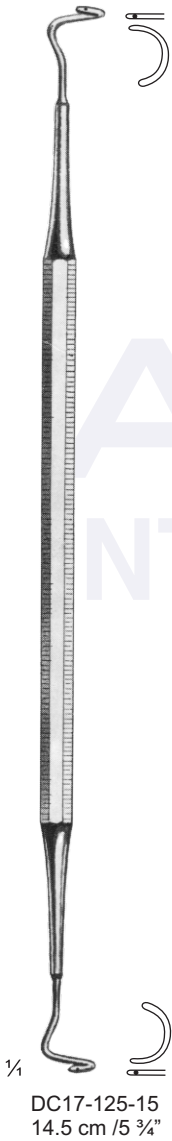

Harms
DC17-127-01
left

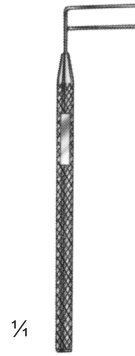

Harms
DC17-127-02
right

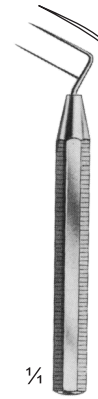

DC17-129-01
5 cm / 2"

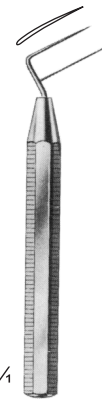

DC17-129-02
5 cm / 2"

ACMA
INTERNATIONAL



Mackensen
DC17-131-01
left

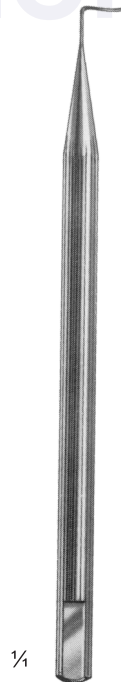

Mackensen
DC17-131-02
right



DC17-133-01
7.5 cm / 3"

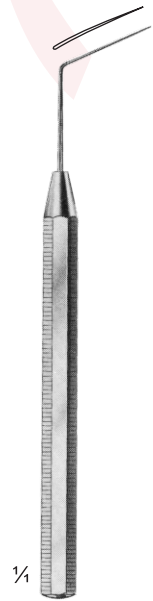

DC17-133-02
7.5 cm / 3"

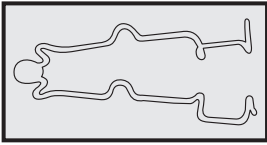

Double-ended Instruments



2/3

Fisher
DC17-135-13



2/3

DC17-137-12



2/3

DC17-139-12

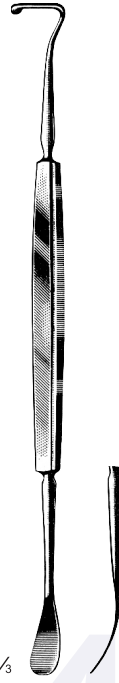

2/3

McReynolds
DC17-141-12



Lindner
DC17-143-13

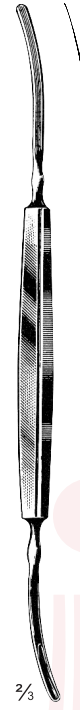

2/3

Smith-Fisher
DC17-145-12

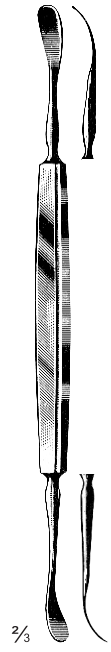

2/3

Green
DC17-147-12



2/3

Knapp
DC17-149-12



2/3

Green
DC17-151-12



2/3

Wheeler
DC17-153-12

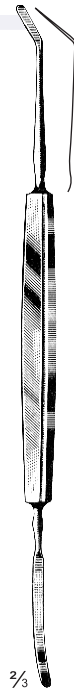

2/3

Castroviejo
DC17-155-12

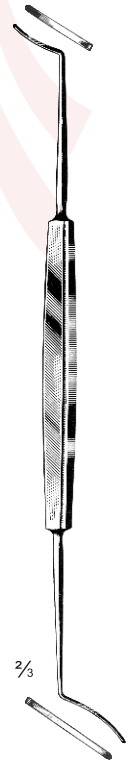

2/3

Castroviejo
width of spatula
mm
0.50 DC17-157-14
0.75 DC17-159-14
1.00 DC17-161-14

Double-ended Instruments, Keratoplastic Knives
Punches, Chisels, Transplant Forceps

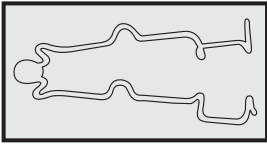

1/4

DC17-163-13

1/4

Moorfield
DC17-165-13

1/4

Meyhoefer
DC17-167-13

1/4

DC17-169-14
DC17-171-14

1/4

West
DC17-173-16

1/4

West
DC17-175-16

2/3

Paton
DC17-177-09

2/3

Berens
DC17-179-10

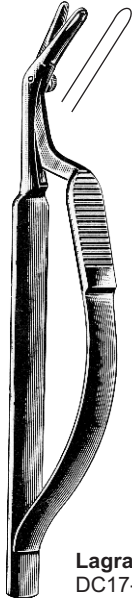

Lagrange
DC17-181-12

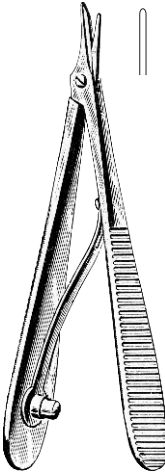

Haitz
DC17-183-09

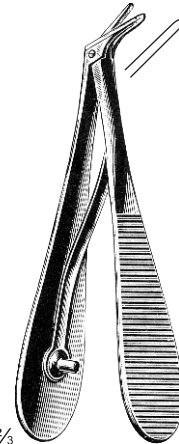

Holth
DC17-185-09



Paufique
DC17-187-11



Barraquer
DC17-189-13



Barraquer
DC17-191-13
7 x 1 mm

Set of Cataract Operating Instrumts by D.B. Kirby

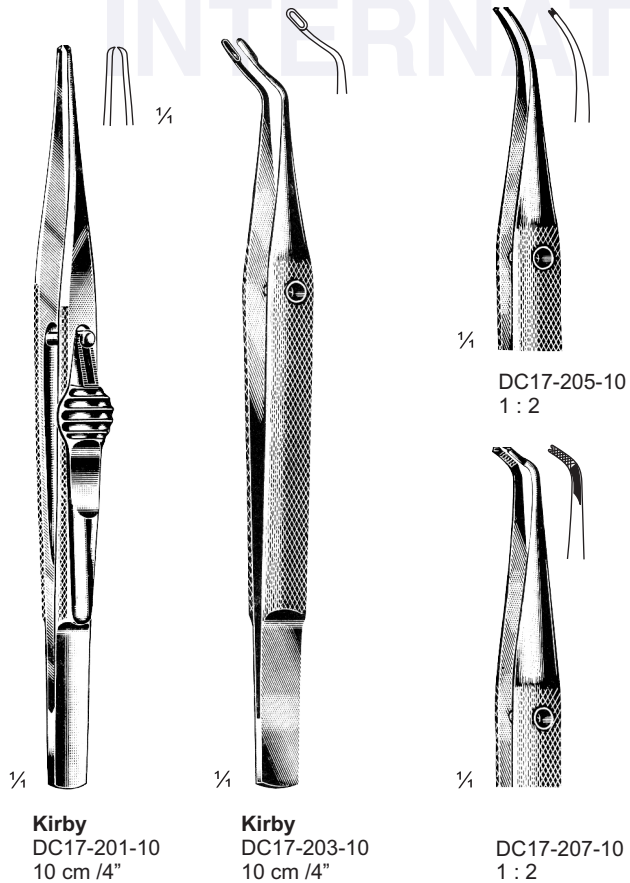
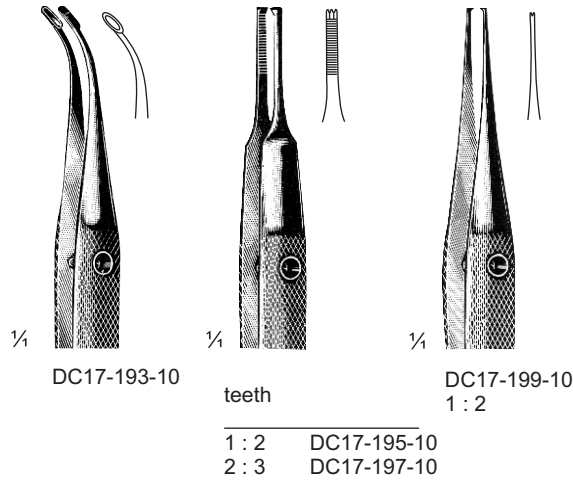
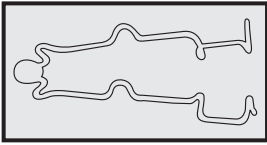

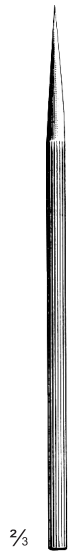
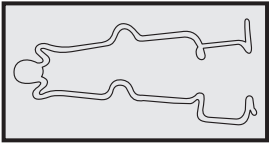

Wilder
DC17-215-01

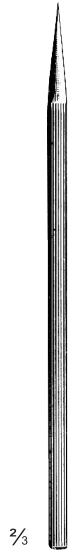

Wilder
DC17-215-02



Wilder
DC17-215-03



Simpson
DC17-217-01

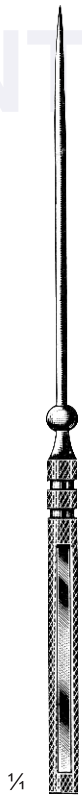

Simpson
DC17-217-02



Castroviejo
DC17-219-12

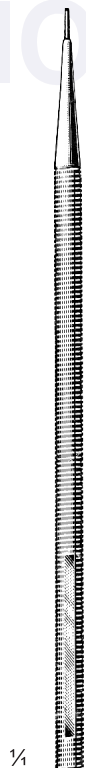

Muldoon
DC17-221-10



Raverdino
DC17-223-08

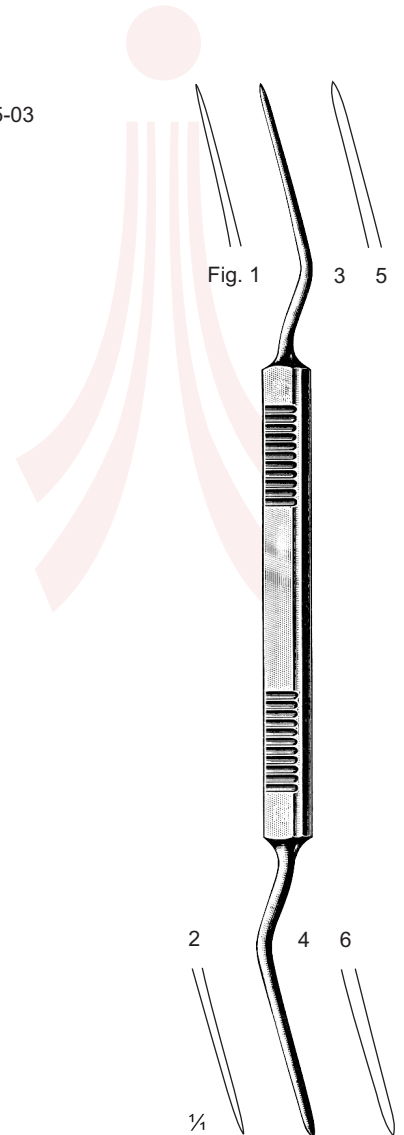

Ziegler
Fig. 1/2 DC17-225-01
Fig. 3/4 DC17-225-02
Fig. 5/6 DC17-225-03

Foreign Body Instruments

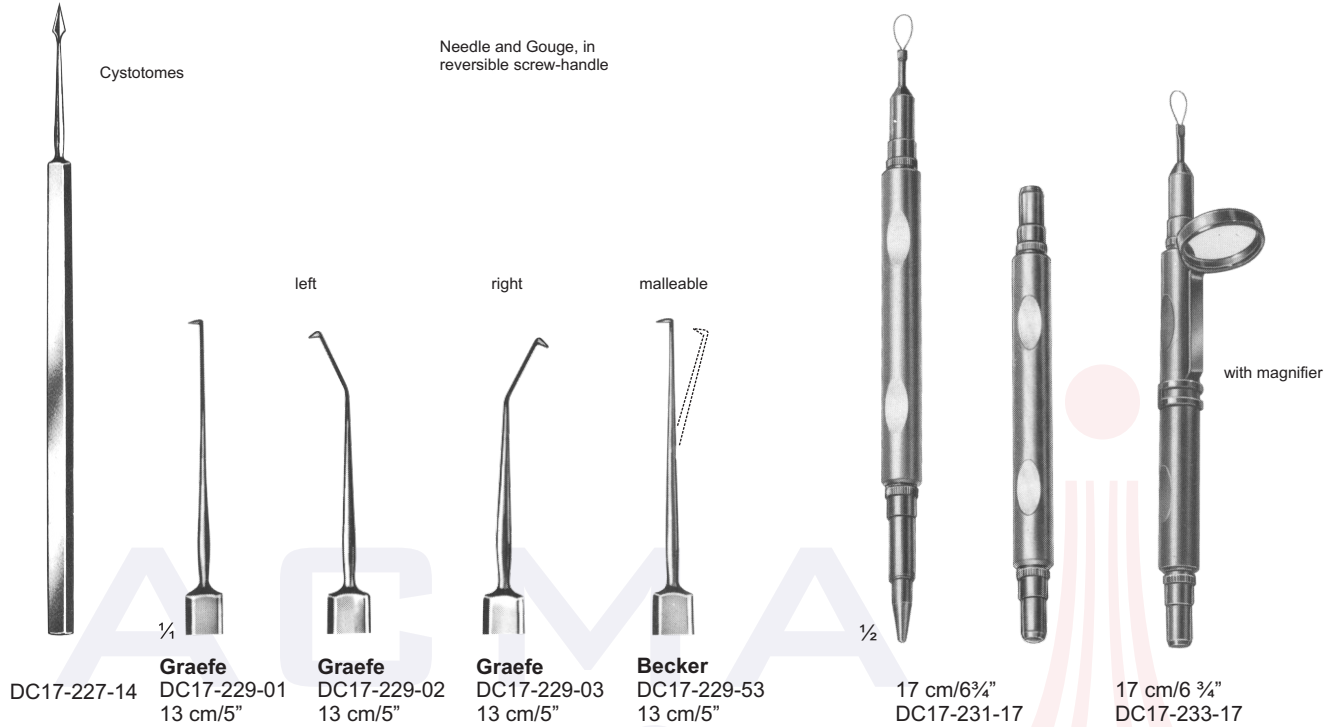
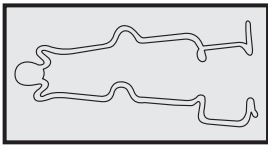

Needle and spud, in round sliding handle

Needle and Gouge, in round sliding handle

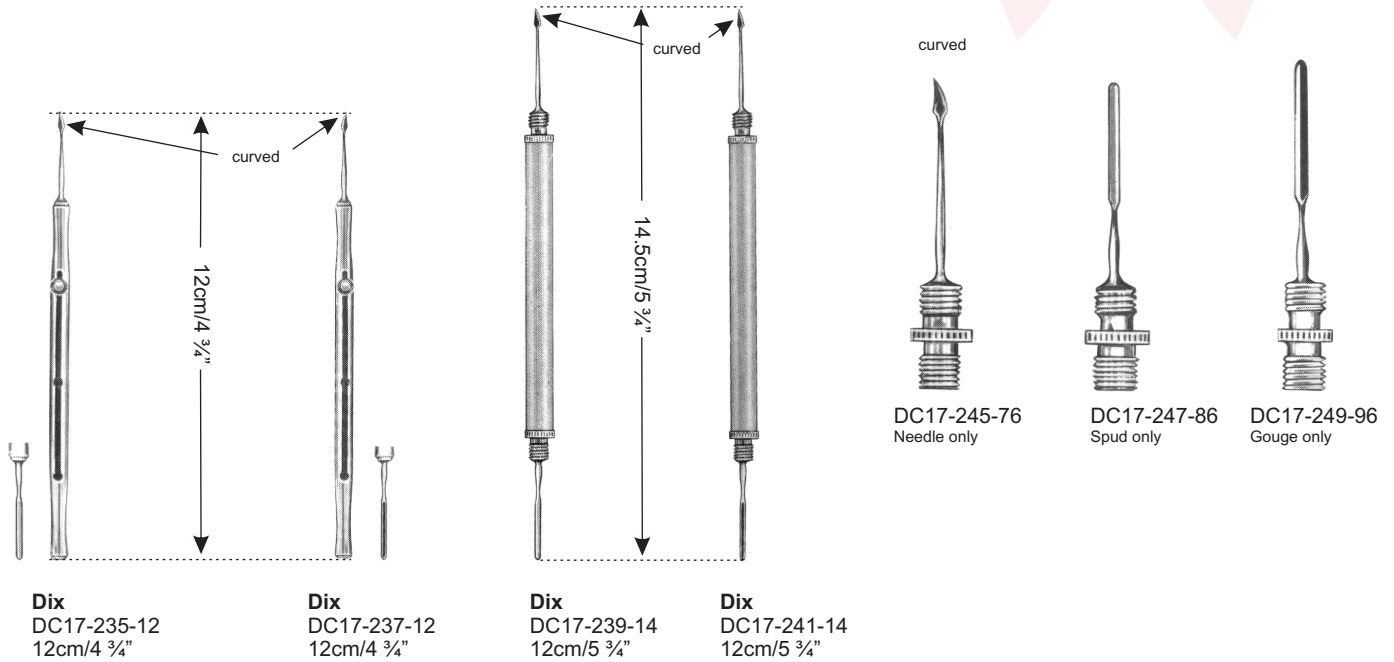

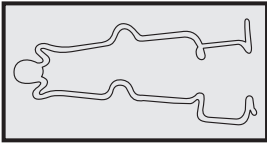

Arruga
DC17-251-13
13 cm/5"

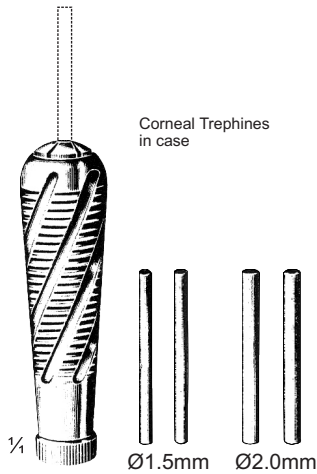

Elliot
DC17-253-00

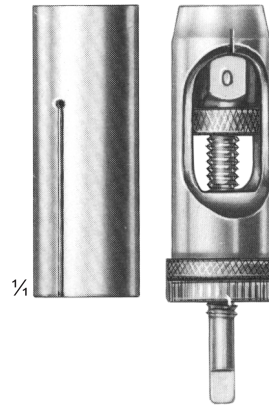

Castroviejo

- DC17-255-00= Ø 5.0mm
- DC17-255-55= Ø 5.5mm
- DC17-255-60= Ø 6.0mm
- DC17-255-65= Ø 6.5mm
- DC17-255-70= Ø 7.0mm
- DC17-255-80= Ø 8.0mm
- DC17-255-90= Ø 9.0mm
- DC17-255-98= Ø 10.0mm
- DC17-255-99= Ø 11.0mm

with adjustable stop

Other patterns on request

Cataract Spoons



Graefe
DC17-257-13
13 cm/5"



Graefe
DC17-259-13
13.5 cm/5 1/4"



Daviel
DC17-261-12
12.5 cm/5"



Daviel
DC17-263-12
12.5 cm/5"



Knapp
DC17-265-14
14 cm/5 1/2"

Enucleation Spoon

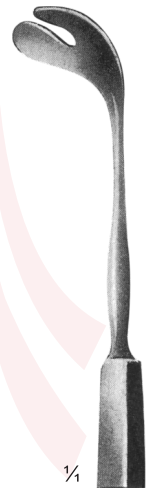

Wells
DC17-267-20
20 cm/8"

Lens Expressor, Lens Loops



Hess
DC17-269-13
14 cm/5"

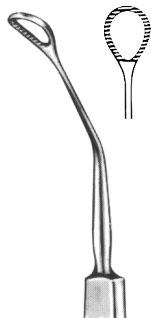

Troutman
DC17-271-13
14 cm/5"



Lewis
DC17-273-14
14 cm/5 1/2"

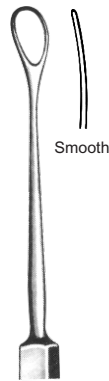

Lewis
DC17-275-14
13 cm/5 1/2"

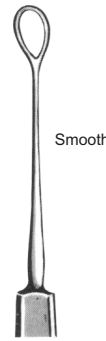

Weber
DC17-277-13
13 cm/5"

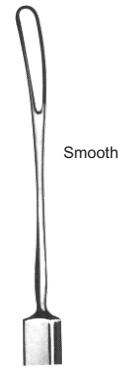

Snellen
DC17-279-13
13 cm/5"



Arlt
13 cm/5"

- DC17-281-13
Smooth
- DC17-283-13
Serrated

Protector

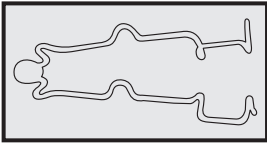

Extraction Hooks for intracapsular cataracts

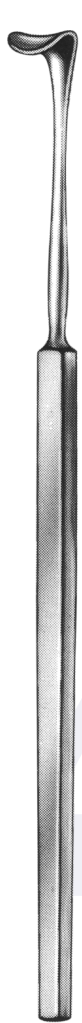

Jaeger
DC17-285-01
13 cm/5"



Jaeger
DC17-285-02
13 cm/5"

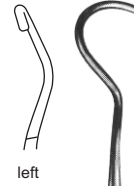

left



Arruga
DC17-287-01
13.5 cm/5¼"



right

Arruga
DC17-287-02
13.5 cm/5¼"

Strabismus Hooks



Stevens
DC17-289-12
12 cm/4¾"



Jameson
DC17-291-13
13 cm/5"



Graefe
DC17-293-13
13 cm/5"



Graefe
DC17-293-14
14 cm/5½"

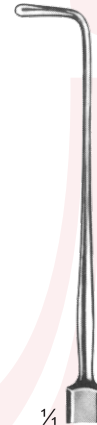

Graefe
DC17-293-15
15 cm/6"

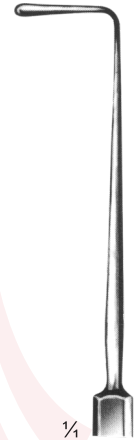

Stevens
DC17-295-14
14 cm/5½"

Hooks for extirpation of the lachrymal gland



DC17-297-02 sharp
DC17-297-12 blunt
14 cm/5"



DC17-297-03 sharp
DC17-297-13 blunt
14 cm/5"

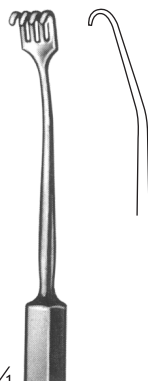

Fink
DC17-299-13
13 cm/5"

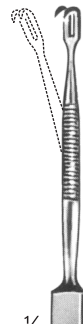

Knapp-Rollet
DC17-301-02
13 cm/5"



Knapp-Rollet
DC17-301-03
13 cm/5"



Knapp-Rollet
DC17-301-04
13 cm/5"

flexible

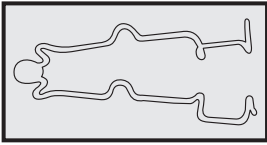

Corneal Dissector



Green
DC17-303-13
13cm/5"



Schweiz. Mod.
DC17-305-13
13 cm/5"



La Force
DC17-307-12
12 cm/4¾"



Meyer
DC17-309-12
12 cm/4¾"



Nicati
DC17-311-12
12 cm/4¾"

Corneal Scarifiers



Kuhnt
DC17-313-12
12cm/4¾"



Kuhnt
DC17-315-13
13cm/5"



Kuhnt
DC17-317-12
12cm/4¾"



Kuhnt
DC17-319-13
13cm/5"

Corneal Knife



Gill
DC17-321-12
12cm/4¾"

Foreign Body Instruments

Discission Needle



Bowman
DC17-323-12
12 cm/4¾"



Bowman
DC17-325-12
12 cm/4¾"

Discissio



Schweigger
DC17-327-12
12 cm/4¾"



DC17-329-12
12cm/4¾"



DC17-331-12
12cm/4¾"

Paracentesis Needle



Desmarres
DC17-333-13
13cm/5"



Desmarres
DC17-335-13
13 cm/5"



DC17-337-13
13 cm/5"



DC17-339-13
13 cm/5"

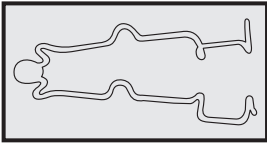

Cyclodialysis Spatula and Spoon, graduated

Iris Spatula

Double Spatula

Cyclodialysis Spatulas

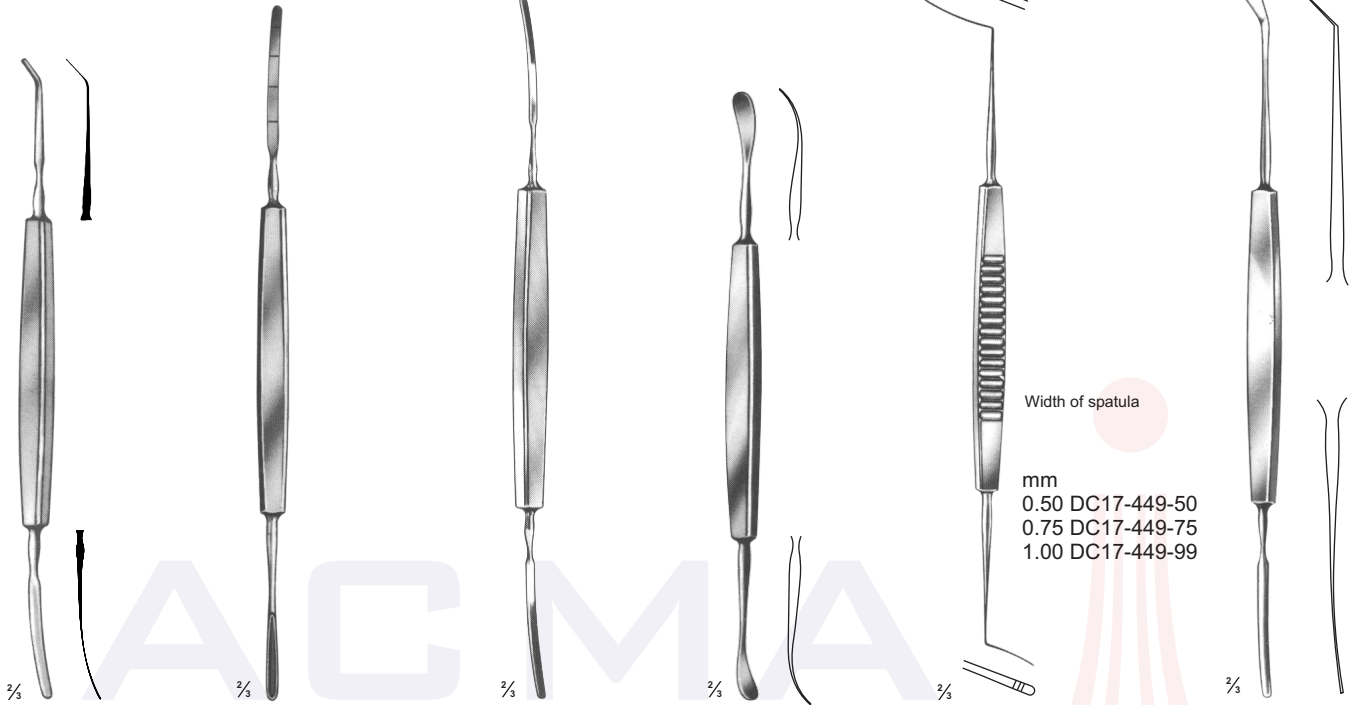

Width of spatula

mm
0.50 DC17-449-50
0.75 DC17-449-75
1.00 DC17-449-99

Wheeler
DC17-441-12
12 cm/4¾"

Lindner
DC17-443-13
13 cm/5"

Smith-Fisher
DC17-445-12
12 cm/4¾"

Green
DC17-447-12
12 cm/4¾"

Castroviejo
14 cm/5½"

Castroviejo
DC17-451-12
12 cm/4¾"

Various Hooks

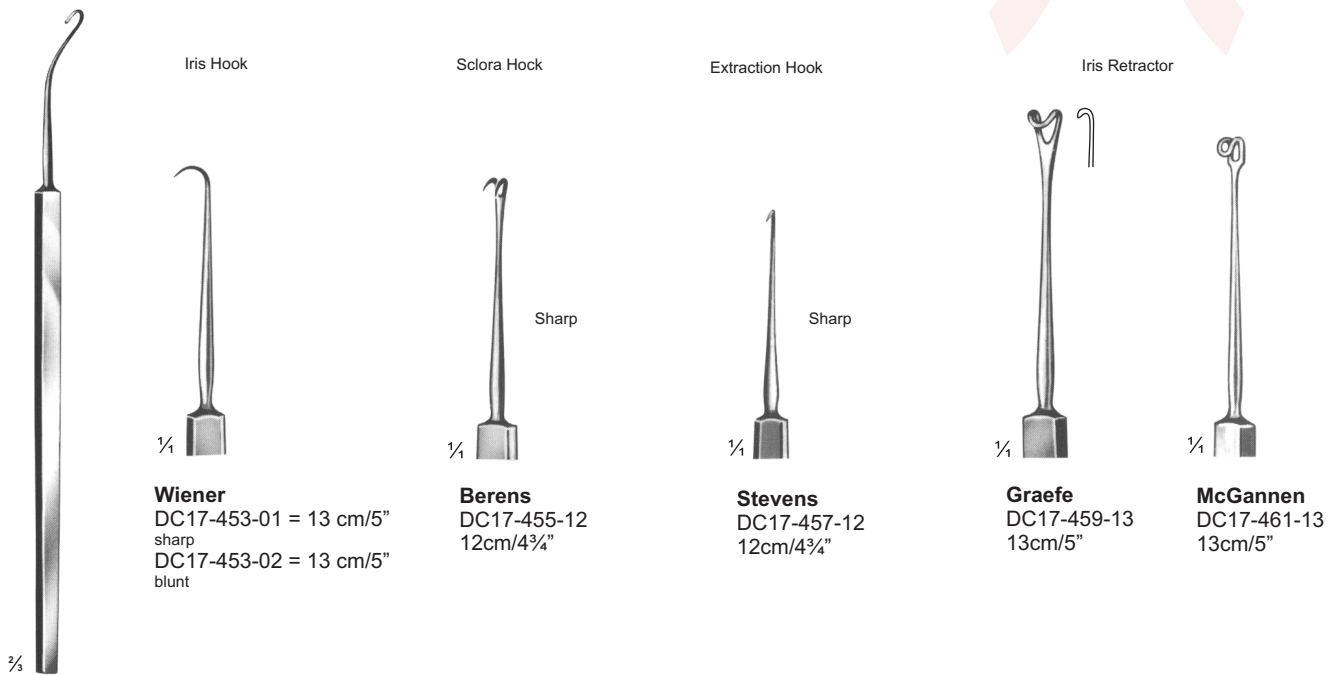

Iris Hook

Sclera Hook

Extraction Hook

Iris Retractor

¼

¼

¼

¼

¼

Wiener
DC17-453-01 = 13 cm/5"
sharp
DC17-453-02 = 13 cm/5"
blunt

Berens
DC17-455-12
12cm/4¾"

Stevens
DC17-457-12
12cm/4¾"

Graefe
DC17-459-13
13cm/5"

McGannan
DC17-461-13
13cm/5"

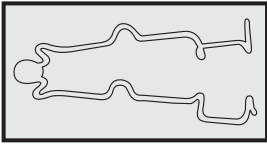

Chalazion Curette,
double-ended, sharp

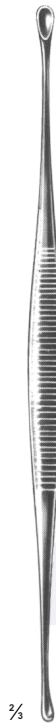

Axenfeld
DC17-463-13
13cm/5"

Lachrymal Sac Dissector

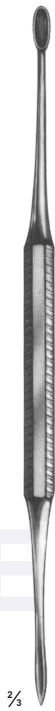

Lang
DC17-465-13
13cm/5"

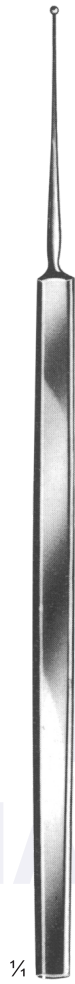

Hebra

Evisceration spoons

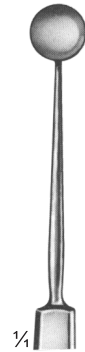

1/4
DC17-467-01

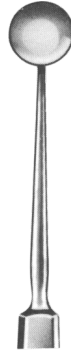

DC17-467-02



DC17-467-03



DC17-467-04



DC17-467-05



1.0mm
DC17-469-10



2.5mm
DC17-469-20



2.5mm
DC17-469-25



3.0mm
DC17-469-30



3.5mm
DC17-469-35

Chalazion Curettes, Lachrymal Sac Dissector



Ø 0.5mm
DC17-471-05



Ø 1.0mm
DC17-471-10



Ø 1.5mm
DC17-471-15



Ø 1.8mm
DC17-471-18



Ø 2.0mm
DC17-471-20



Ø 2.5mm
DC17-471-25



Ø 3.5mm
DC17-471-35



Ø 4.0mm
DC17-471-40



Ø 4.5mm
DC17-471-45

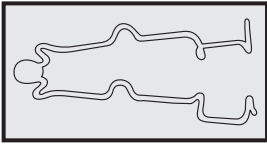

1/4

Graefe
 DC17-473-05 = 0.5 mm
 DC17-473-07 = 0.7 mm
 DC17-473-10 = 1.0 mm
 7 cm / 2 3/4"

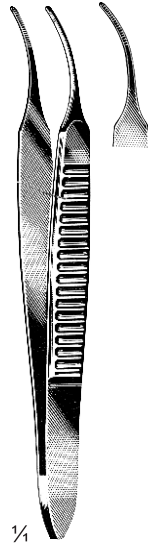

1/4

Graefe
 DC17-475-05 = 0.5 mm
 DC17-475-07 = 0.7 mm
 DC17-475-10 = 1.0 mm
 7 cm / 2 3/4"

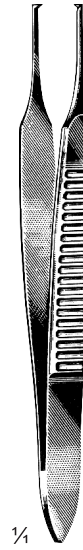

1/4

1 : 2
Graefe
 DC17-477-05 = 0.5 mm
 DC17-477-07 = 0.7 mm
 DC17-477-10 = 1.0 mm
 7 cm / 2 3/4"

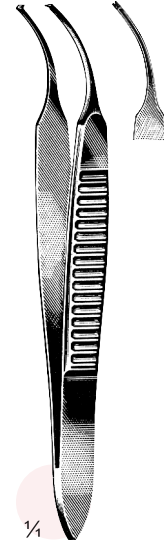

1/4

1 : 2
Graefe
 DC17-479-05 = 0.5 mm
 DC17-479-07 = 0.7 mm
 DC17-479-10 = 1.0 mm
 7 cm / 2 3/4"

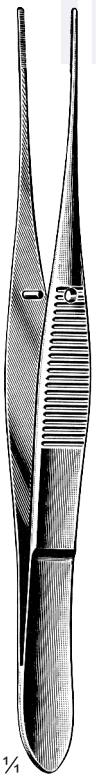

1/4

Graefe

7 cm / 2 3/4"
 10 cm / 4"

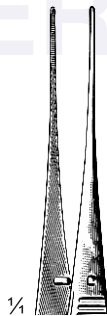

1/4

DC17-481-07
 DC17-481-10

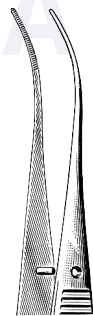

DC17-483-07
 DC17-483-10

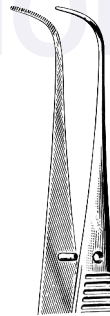

DC17-485-07
 DC17-485-10

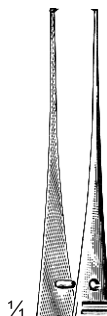

1/4

7 cm / 2 3/4"
 10 cm / 4"

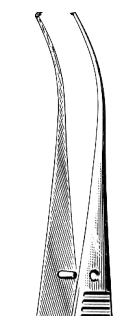

DC17-489-07
 DC17-489-10

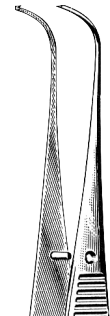

DC17-491-07
 DC17-491-10

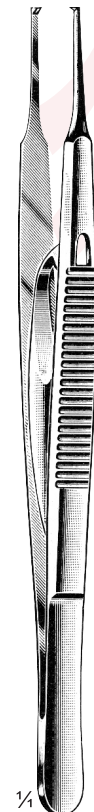

1/4

Stevens
 DC17-493-11
 11 cm / 4 1/2"

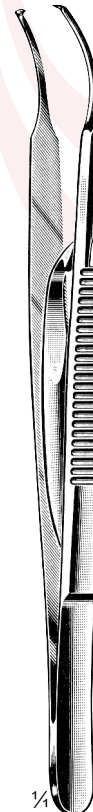

1/4

Stevens
 DC17-495-11
 11 cm / 4 1/2"

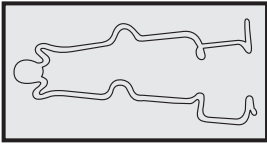

Iris Forceps, Conjunctival Forceps

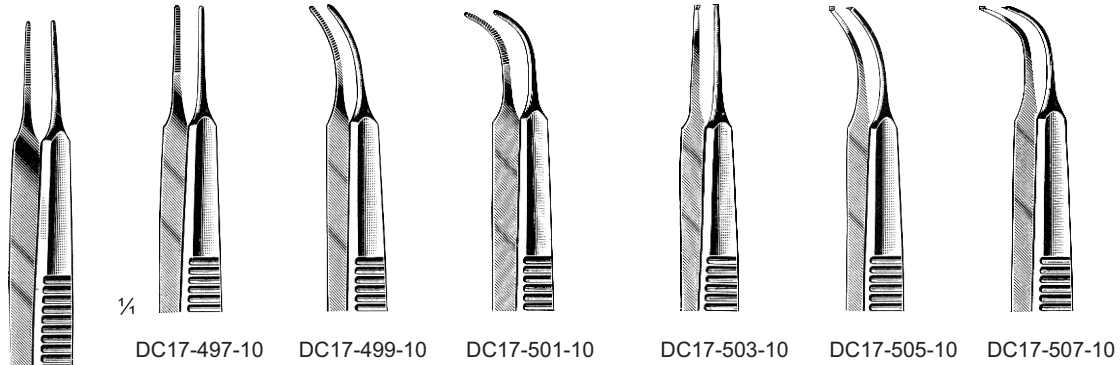

DC17-497-10 DC17-499-10 DC17-501-10 DC17-503-10 DC17-505-10 DC17-507-10



Stevens
10.5 cm / 4 1/2"

without teeth

with 1 : 2 teeth

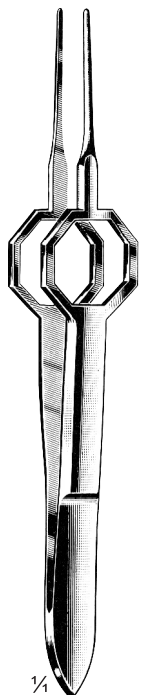

Foerster
DC17-509-08
8.5 cm / 3 1/2"

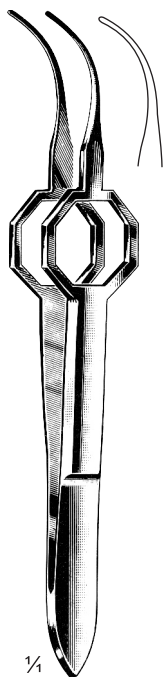

Foerster
DC17-511-08
8.5 cm / 3 1/2"

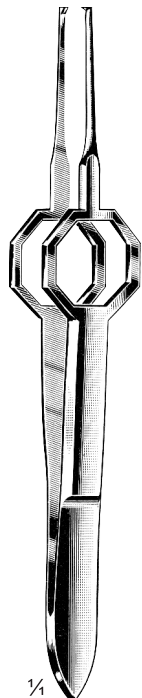

Foerster
DC17-513-08
8.5 cm / 3 1/2"

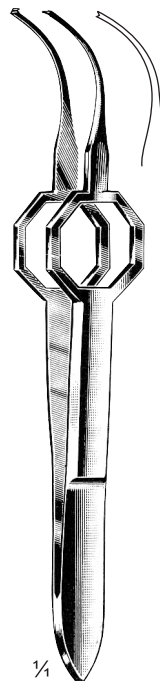

Foerster
DC17-515-08
8.5 cm / 3 1/2"



Chandler
DC17-517-07 serrated
DC17-519-07 smooth
7 cm / 2 3/4"

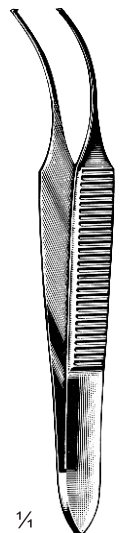

Fuchs
DC17-521-07
7 cm / 2 3/4"

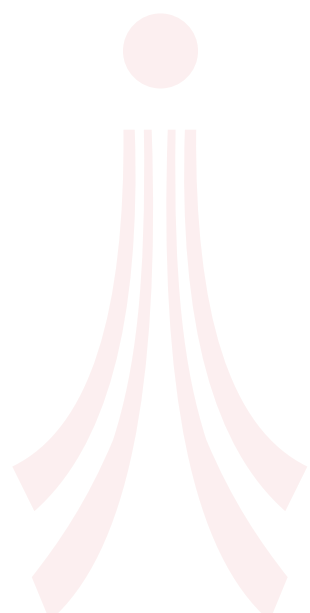

ACMA
INTERNATIONAL

Iris Forceps, Conjunctival Forceps, Fixation Forceps

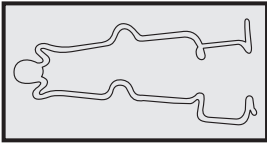

1:2
Mod. Bonn
DC17-523-07
7 cm / 2 3/4"
with guide pin



1:2
Mod. Bonn
DC17-525-07
7 cm / 2 3/4"
without guide pin

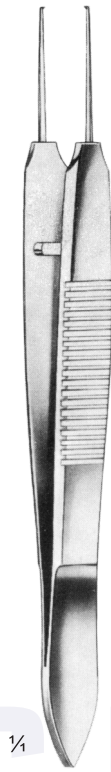

1/4
Mod. Bonn
DC17-527-10
10 cm / 4"



1/4
Elliot
DC17-529-10
10 cm / 4"



1/4
Fischer
DC17-531-07
7 cm / 2 3/4"



1/4
Fischer-Arlt
DC17-533-07
7 cm / 2 3/4"

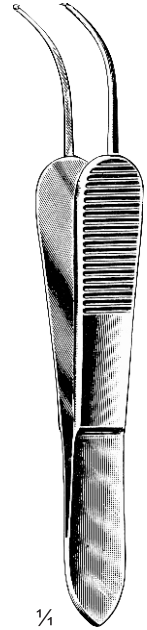

1/4
Panas
DC17-535-08
8 cm / 3 1/4"

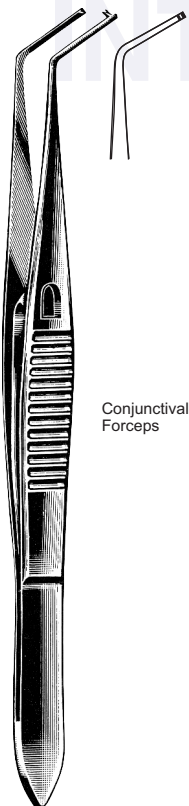

Conjunctival
Forceps

1/4
O'Connor
DC17-537-10
10 cm / 4"

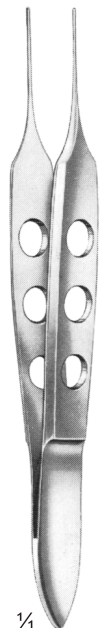

1/4
Bishop-Harman
DC17-539-08
8.5 cm / 3 1/2"

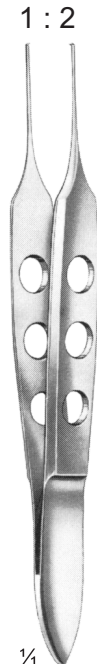

1:2
Bishop-Harman
DC17-541-08
8.5 cm / 3 1/2"



1/4
Bishop-Harman
DC17-543-08
8.5 cm / 3 1/2"



1/4
Bishop-Harman
DC17-545-08
8.5 cm / 3 1/2"

Iris Forceps, Fixation Forceps, Capsular Forceps

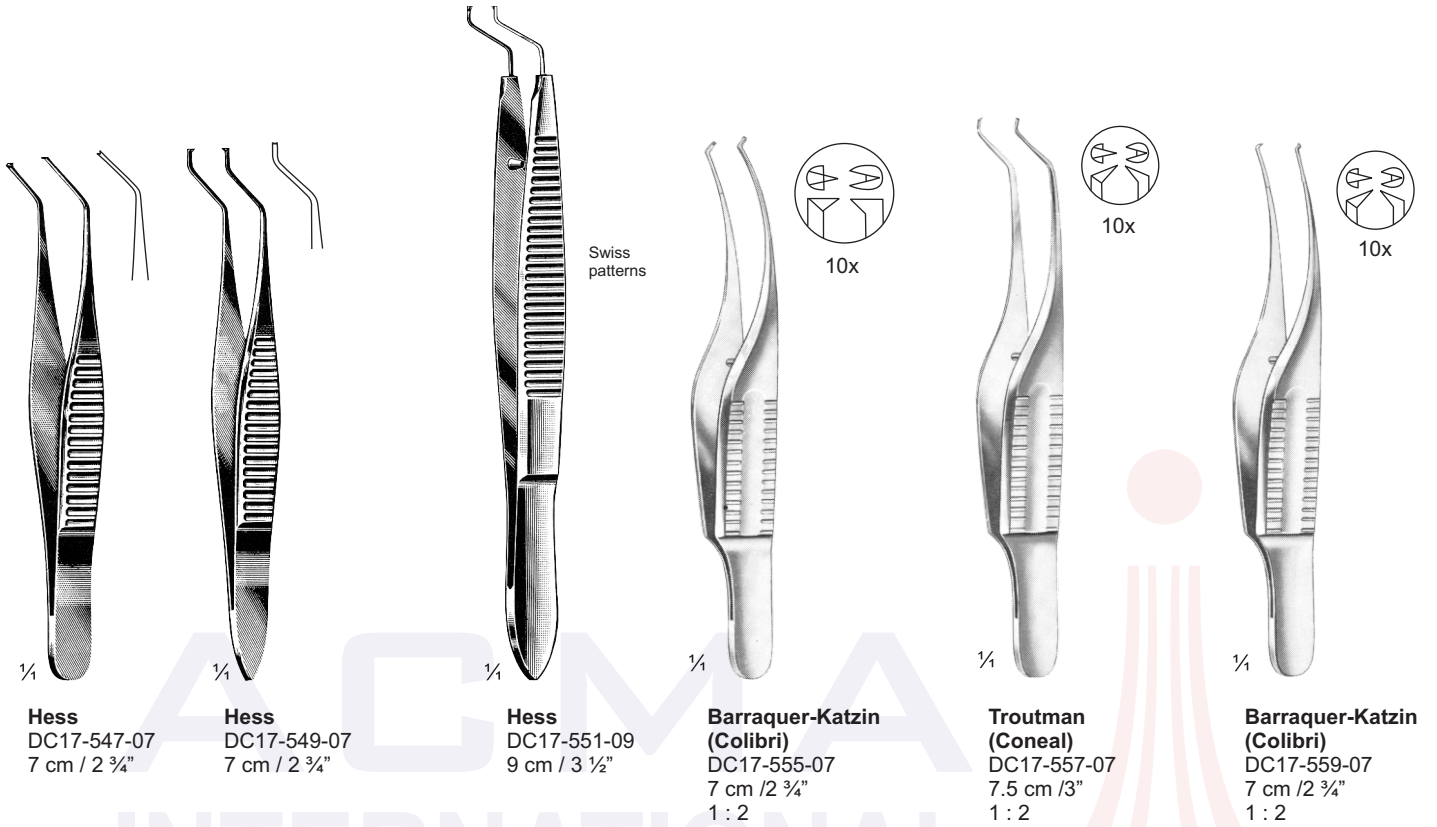
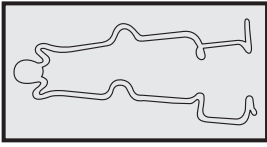

Hess
DC17-547-07
7 cm / 2 3/4"

Hess
DC17-549-07
7 cm / 2 3/4"

Hess
DC17-551-09
9 cm / 3 1/2"

Barraquer-Katzin (Colibri)
DC17-555-07
7 cm / 2 3/4"
1 : 2

Troutman (Coneal)
DC17-557-07
7.5 cm / 3"
1 : 2

Barraquer-Katzin (Colibri)
DC17-559-07
7 cm / 2 3/4"
1 : 2

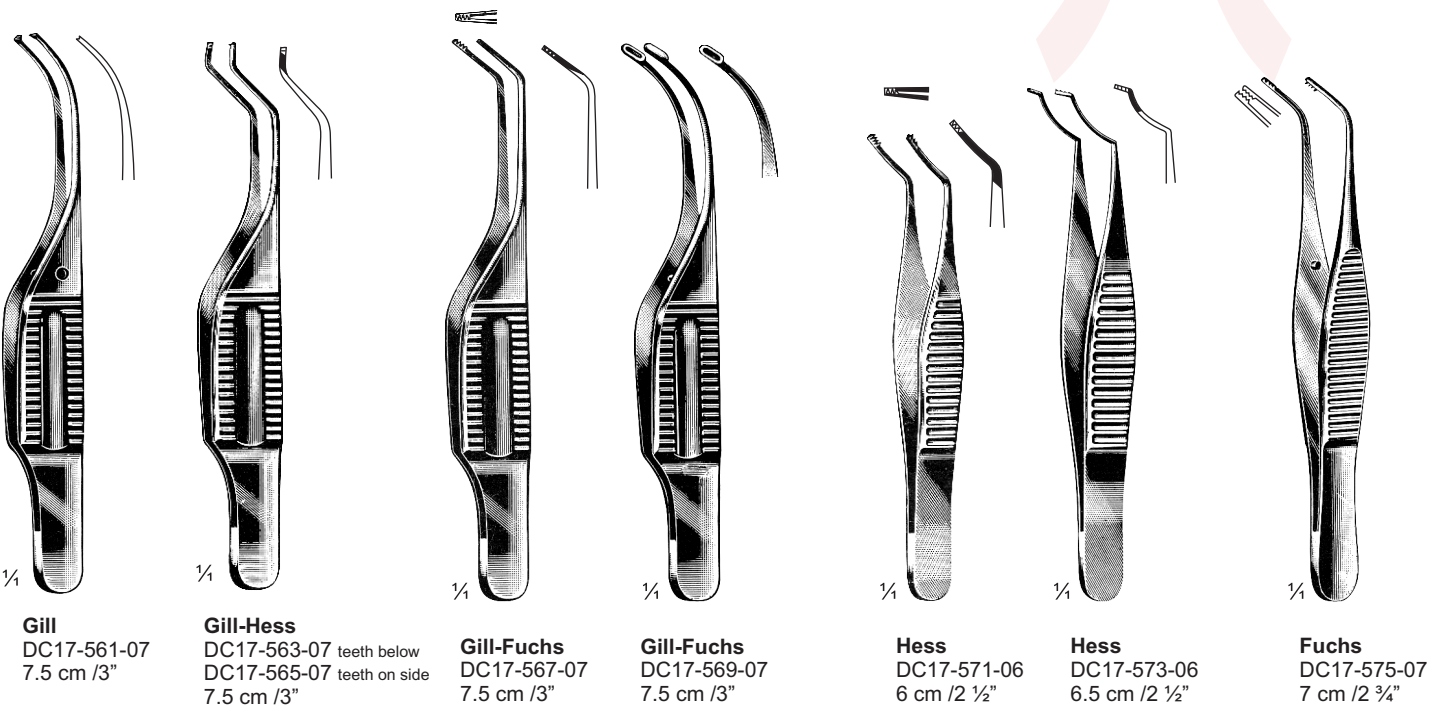

Gill
DC17-561-07
7.5 cm / 3"

Gill-Hess
DC17-563-07 teeth below
DC17-565-07 teeth on side
7.5 cm / 3"

Gill-Fuchs
DC17-567-07
7.5 cm / 3"

Gill-Fuchs
DC17-569-07
7.5 cm / 3"

Hess
DC17-571-06
6 cm / 2 1/2"

Hess
DC17-573-06
6.5 cm / 2 1/2"

Fuchs
DC17-575-07
7 cm / 2 3/4"

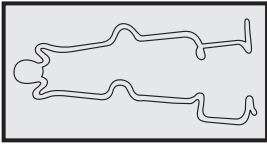

Capsular Forceps

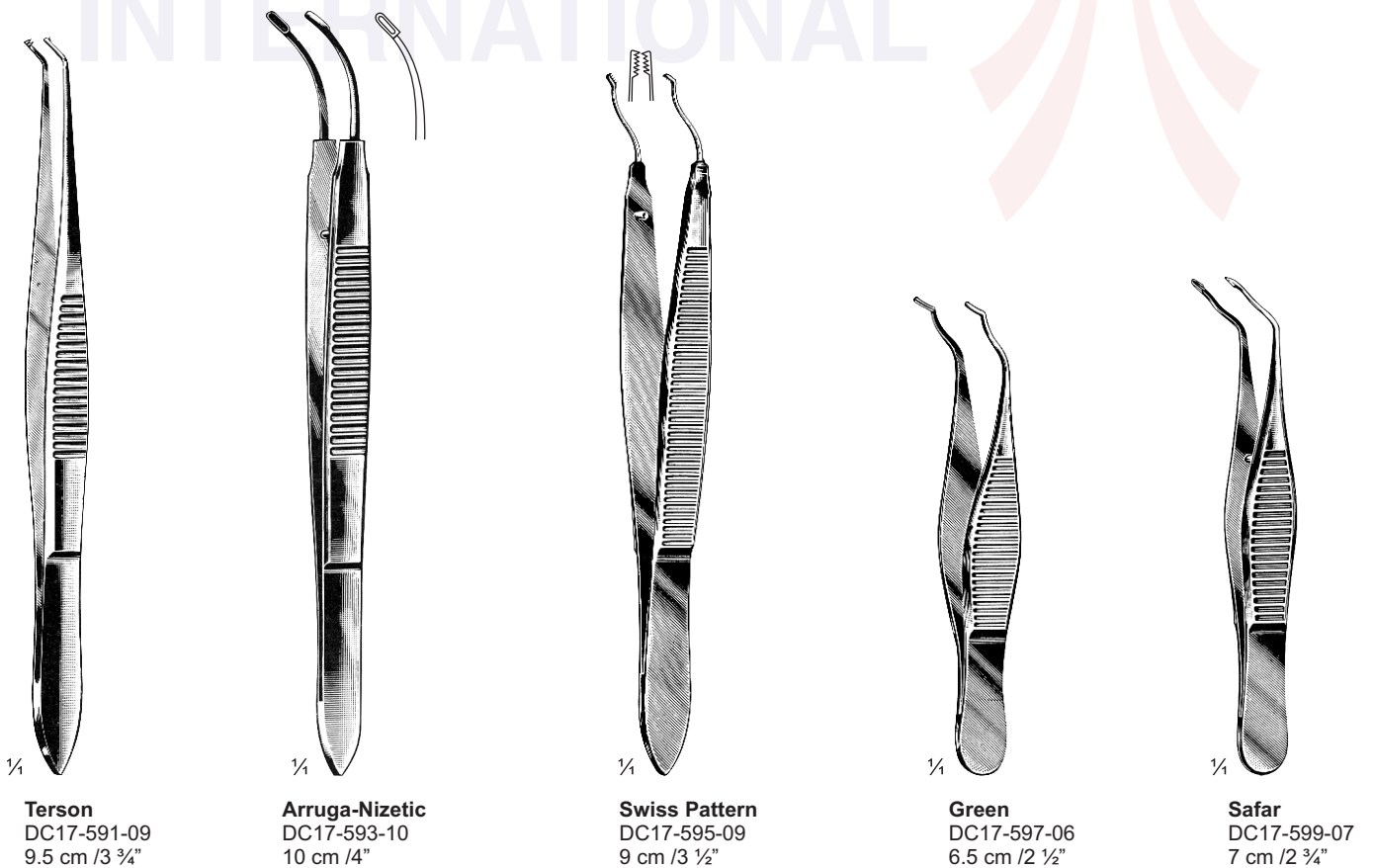

Capsular Forceps

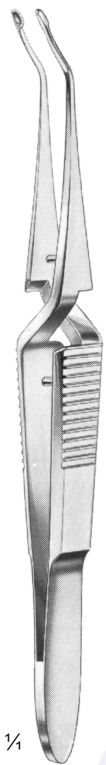
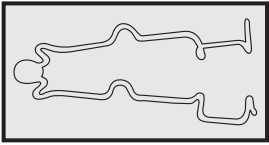

Castroviejo
DC17-601-10
10 cm / 4"

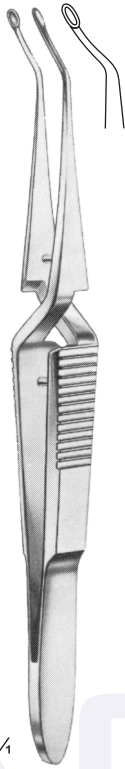

Castroviejo
DC17-603-10
10 cm / 4"

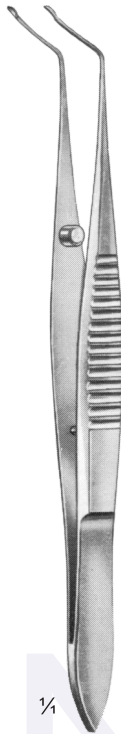

Kalt
DC17-605-10
10 cm / 4"

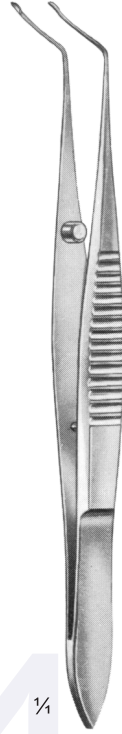

Kalt
DC17-607-10
10 cm / 4"

calibrated

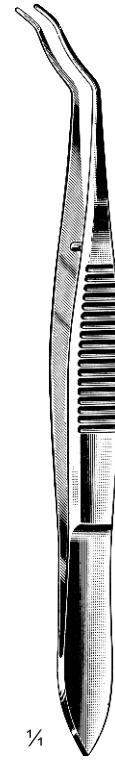

Elschnig
DC17-609-10
10 cm / 4"

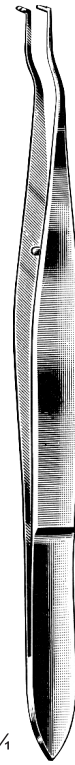

Barraquer
DC17-611-10
10 cm / 4"

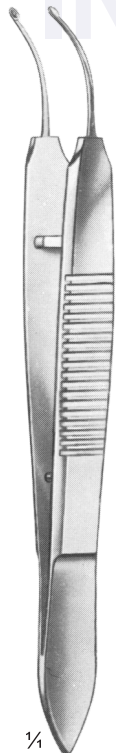

Arruga
DC17-613-10
10 cm / 4"

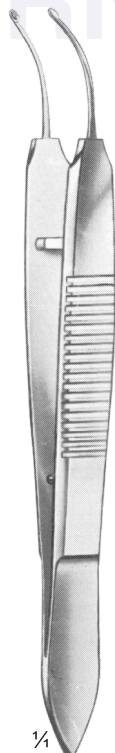

Arruga
DC17-615-10
10 cm / 4"

calibrated

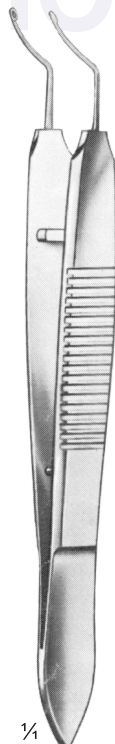

Arruga
DC17-617-10
10 cm / 4"

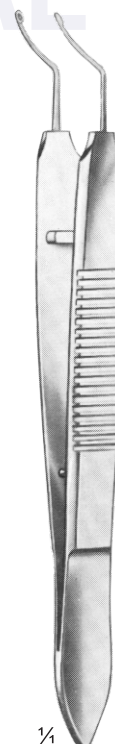

Arruga-Eschnig
DC17-619-10
10 cm / 4"

calibrated

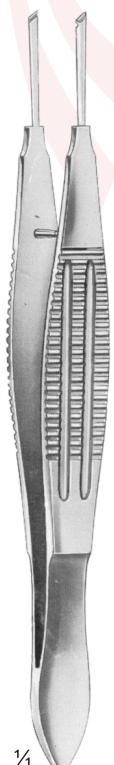

Choyce
DC17-621-10
10 cm / 4"



without
Irrigator

Fixation Forceps, Tissue Forceps

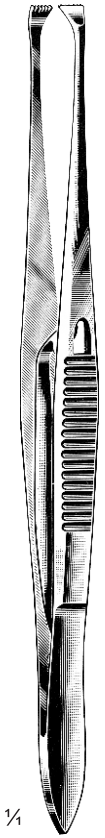
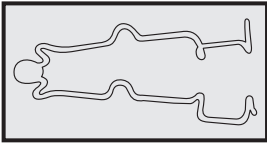

1/4

Graefe
DC17-623-11
without spring catch
DC17-625-11
with spring catch
11 cm / 4 1/2"



5x

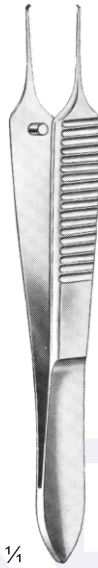

1/4

**Sauer
Mod. Martin**
DC17-627-07
7.5 cm / 3"



5x

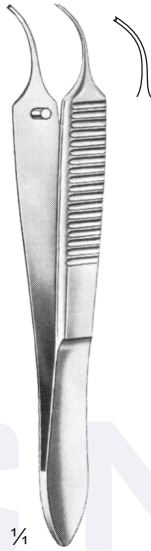

1/4

**Sauer
Mod. Martin**
DC17-629-07
7.5 cm / 3"

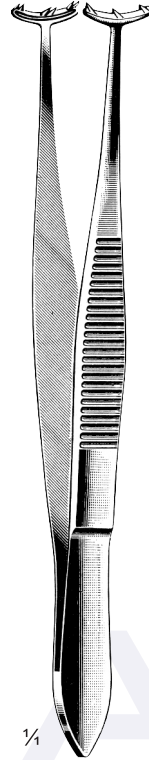

1/4

Barraquer
DC17-631-10
10 cm / 4"

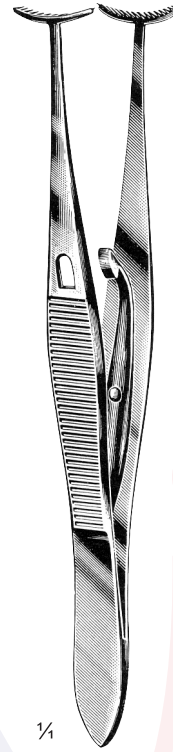

1/4

Green
DC17-633-05 - DC17-635-10
10 cm / 4"

wide without spring catch

5 mm DC17-633-05
10 mm DC17-633-10

wide with spring catch

5 mm DC17-635-05
10 mm DC17-635-10

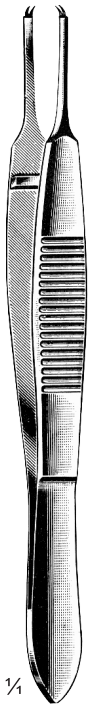

1/4

Castroviejo
DC17-637-09
9 cm / 3 1/2"

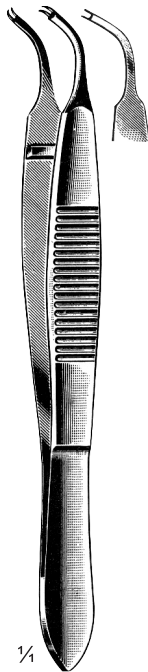

1/4

Castroviejo
DC17-639-09
9 cm / 3 1/2"



1/4

Castroviejo
DC17-641-09
9 cm / 3 1/2"

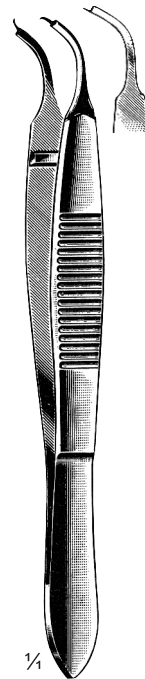

1/4

Castroviejo
DC17-643-09
9 cm / 3 1/2"

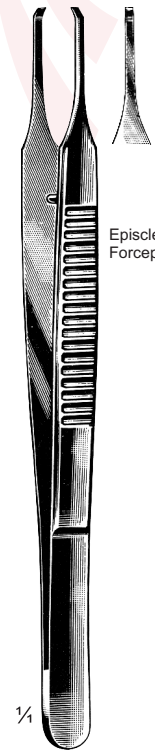

1/4

Episclear
Forceps

DC17-645-10
10 cm / 4"

Fixation Forceps, Tissue Forceps, Suture Forceps

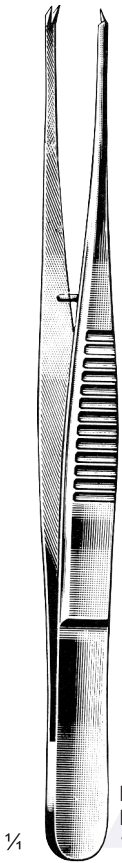
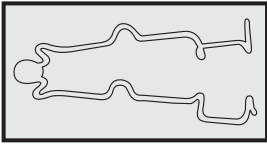

Elschnig
DC17-647-11
11 cm / 4 1/2"

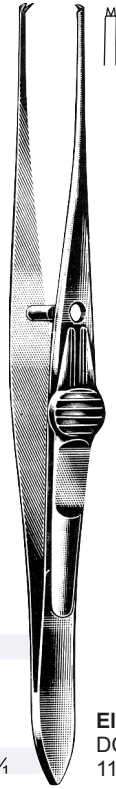

Elschnig
DC17-649-11
11 cm / 4 1/2"

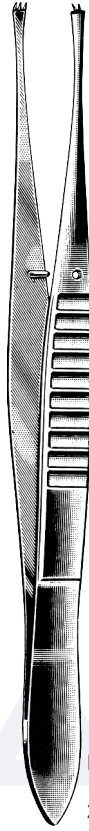

DC17-651-11
11 cm / 4 1/2"
2 : 3

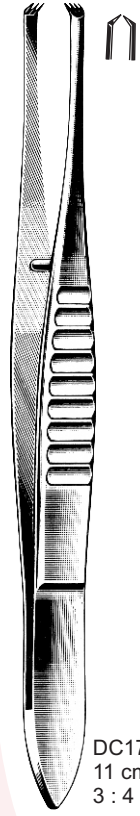

DC17-653-11
11 cm / 4 1/2"
3 : 4



Fieringa
Ring Forceps

Barraquer-Llovera
DC17-655-09
9 cm / 3 1/2"

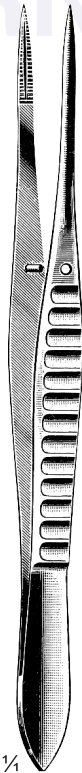

Moorfield
DC17-657-10
10 cm / 4"



Dastoor
DC17-659-10
10 cm / 4"

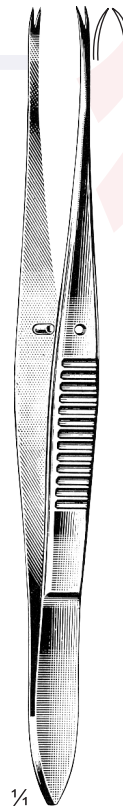

Guist
DC17-661-10
10.5 cm / 4 1/4"

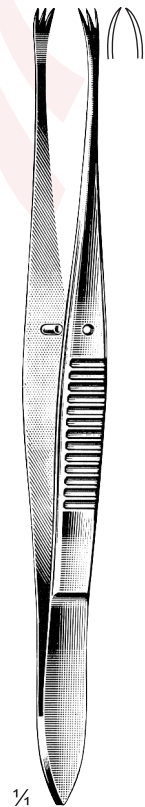

Guist
DC17-663-10
10.5 cm / 4 1/4"

Suture Forceps, Strabismus Forceps, Anterior Chamber Forceps

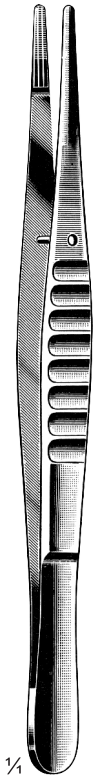
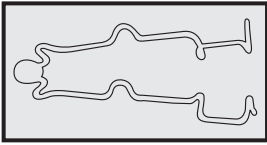

Bonaccolto
DC17-665-10
10 cm / 4"

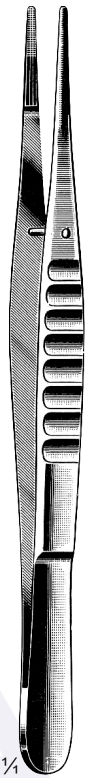

Bonaccolto
DC17-667-10
10 cm / 4"

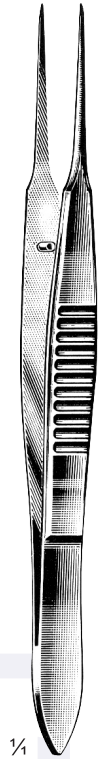

Bonaccolto
DC17-669-11
11 cm / 4 1/2"

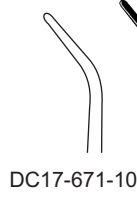

Nugent
10 cm / 4"

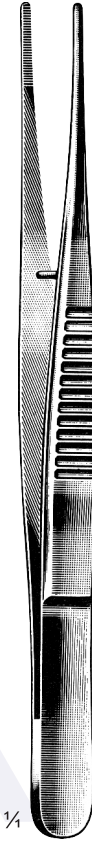
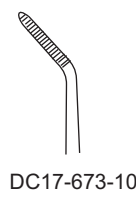

DC17-675-11
11 cm / 4 1/2"

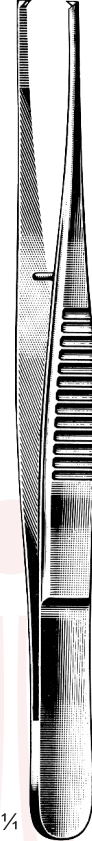

DC17-677-11
11 cm / 4 1/2"
1 : 2

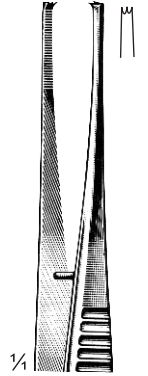

DC17-679-11
11 cm / 4 1/2"
2 : 3

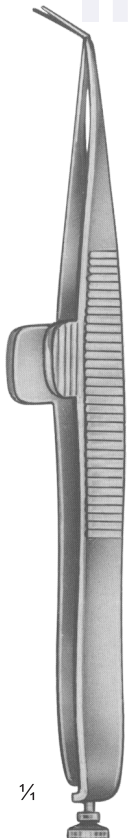

Elschnig
DC17-681-11
11cm/4 1/4"

Anterior Chamber Forceps

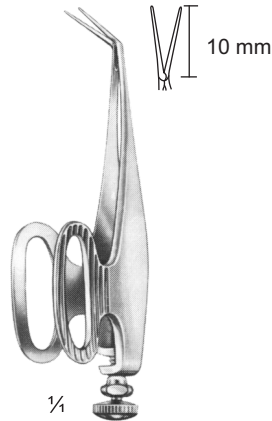

Barraquer
DC17-683-15
5.5 cm / 2 1/4"

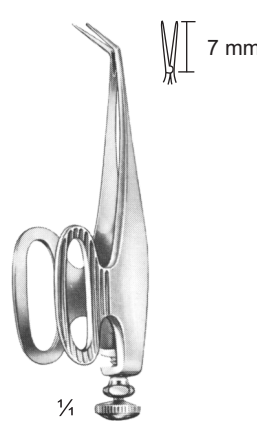

Barraquer
DC17-683-25
5.5 cm / 2 1/4"

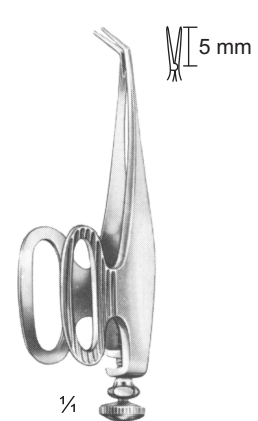

Barraquer
DC17-685-05
5.5 cm / 2 1/4"

Muscular Forceps, Strabismus, Capsular Forceps

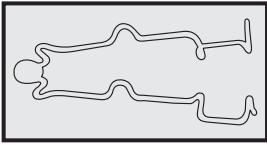

1/4

McCullough
DC17-687-09
9.5 cm / 3 3/4"



1/4

McCullough
DC17-689-09
9.5 cm / 3 3/4"

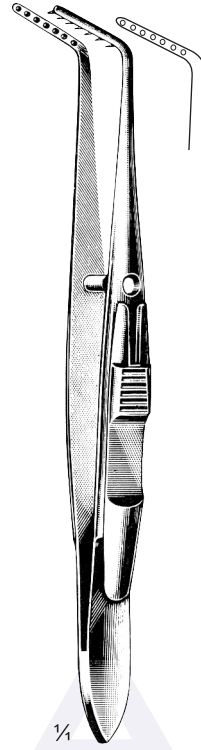

1/4

Jameson
DC17-691-10
10 cm / 4"

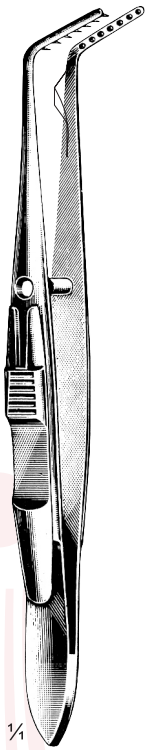

1/4

Jameson
DC17-693-10
10 cm / 4"

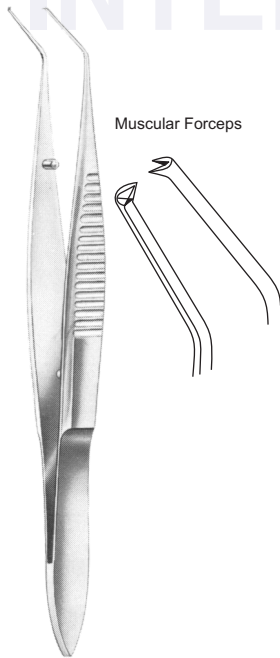

Troutman Rectus
DC17-695-10
8.5 cm / 3 1/2"
1 : 2



McPherson
DC17-697-20



McPherson
DC17-697-30

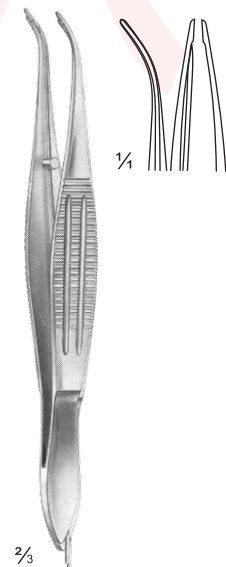

2/3

Hirschmann
DC17-697-40
with Irrigator
DC17-697-50
without Irrigator

Chalazion Forceps

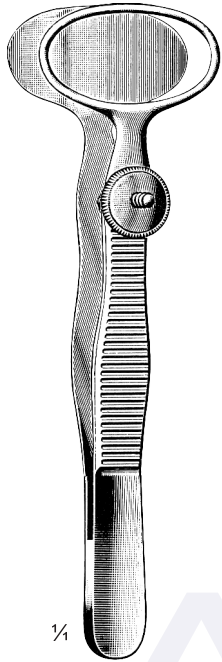
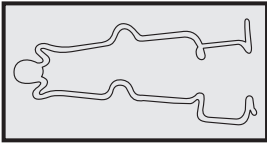

Desmarres
DC17-699-09 - DC17-703-09
9 cm / 3 1/2"

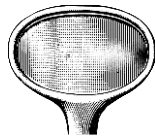

DC17-699-09

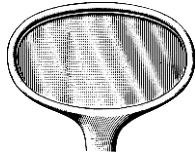

DC17-701-09

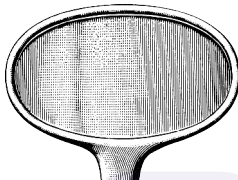

DC17-703-09

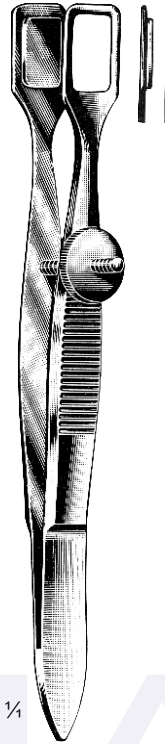

Weaver
DC17-705-10
10 cm / 4"

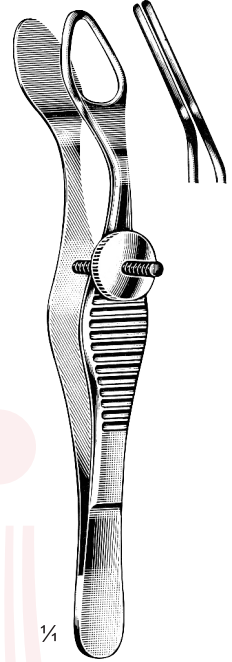

Lordan
DC17-707-09
9 cm / 3 1/2"

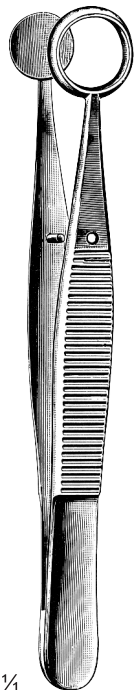

Ayer
DC17-713-09
9 cm / 3 1/2"

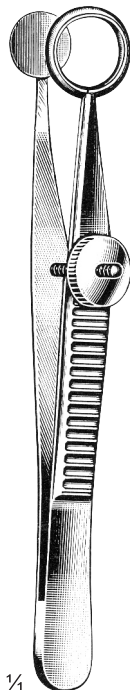

Ayer
DC17-715-09
9 cm / 3 1/2"

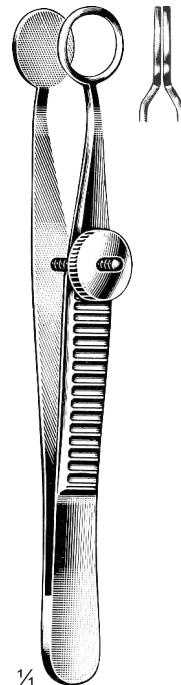

Lambert
DC17-717-09
9 cm / 3 1/2"

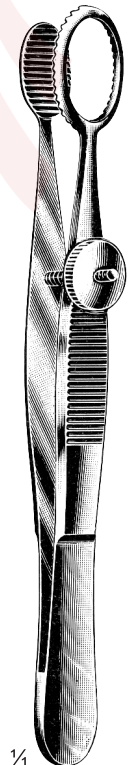

Cauzer
DC17-719-10
10 cm / 4"

Muscular Forceps, Advancement and Entropium Forceps
Suture Forceps, Trachoma Forceps

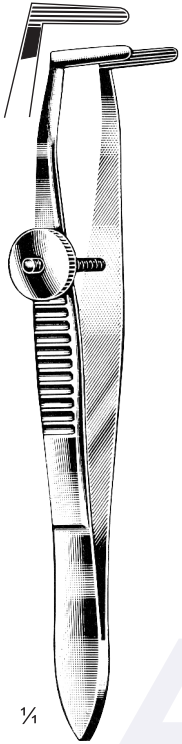
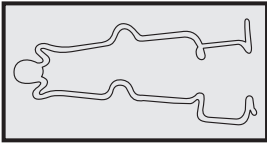

Blascovics
DC17-721-09
9 cm / 3 1/2"

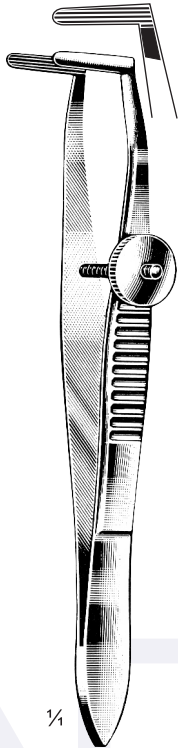

Blascovics
DC17-723-09
9 cm / 3 1/2"

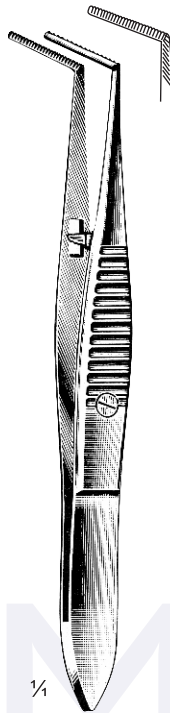

Reese
DC17-725-10
10 cm / 4"

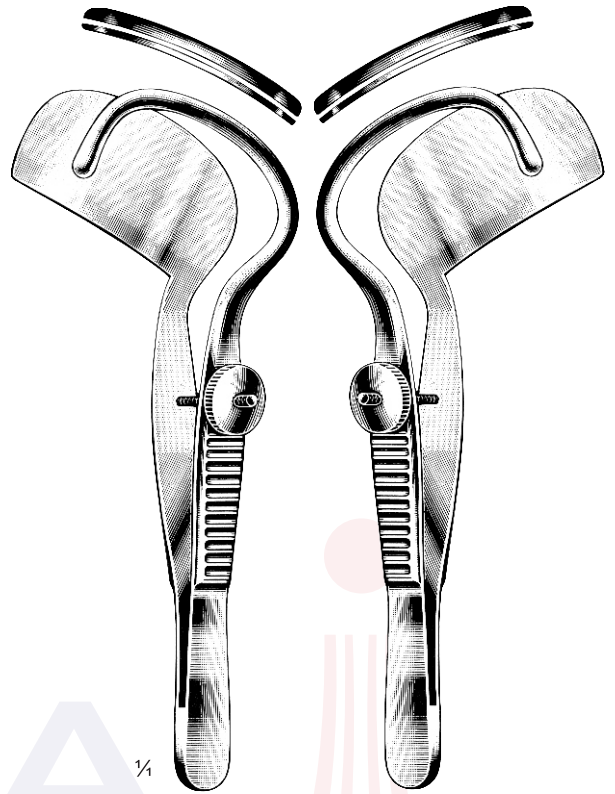

DC17-727-10

DC17-729-10

Snellen
10 cm / 4"

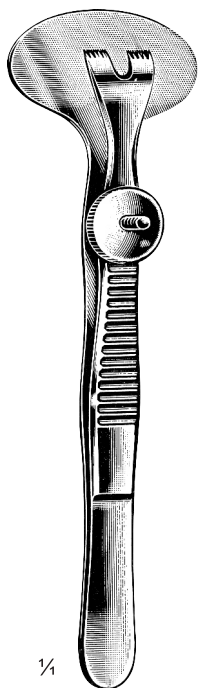

Erhardt
DC17-731-09
9 cm / 3 1/2"

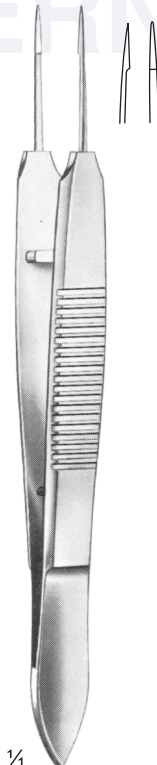

Mod. Tubingen
DC17-733-10
10 cm / 4"

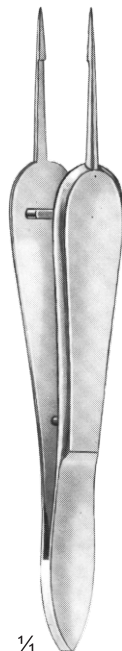

DC17-735-08
8.5 cm / 3 1/2"

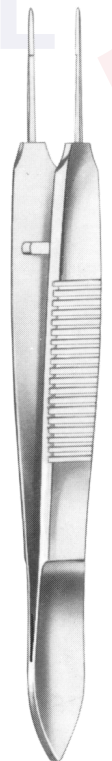

McPherson
DC17-737-08 = 7.5 cm / 3"
DC17-737-10 = 10 cm / 4"

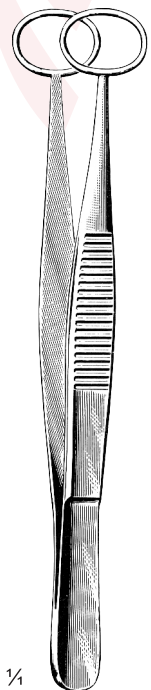

Prince
DC17-739-09
9 cm / 3 1/2"

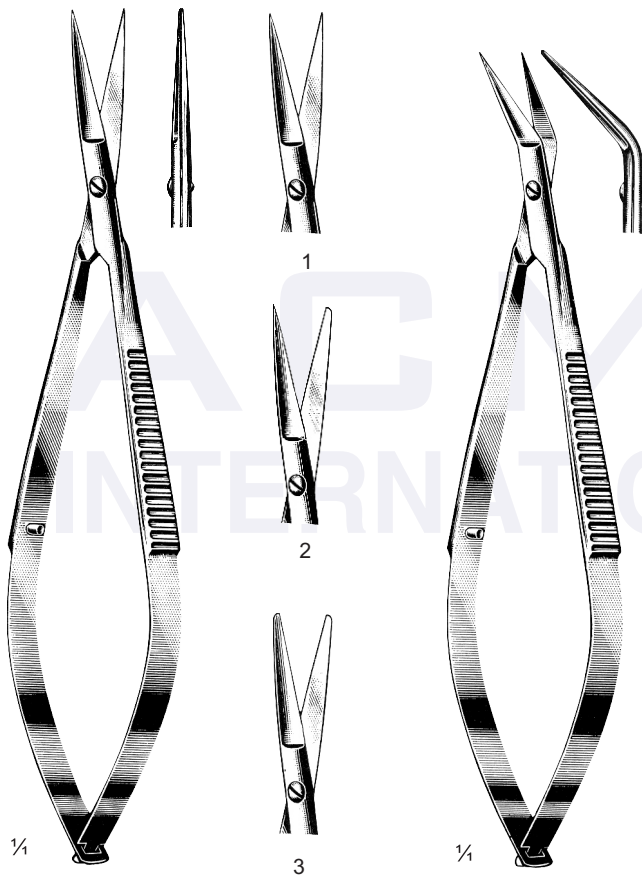
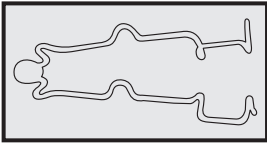

Noyes
12 cm / 4 3/4"
Fig.

- 1 DC17-741-12
- 2 DC17-743-12
- 3 DC17-745-12

Noyes
12 cm / 4 3/4"
Fig.

- 1 DC17-747-12
- 2 DC17-749-12
- 3 DC17-751-12



Wecker
Mod. Martin
DC17-753-11
11 cm / 4 1/2"

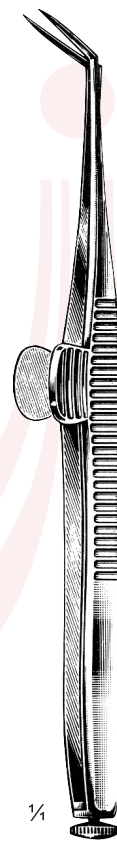

Wecker
11 cm / 4 1/2"



DC17-755-11



DC17-757-11



DC17-759-11

Delicate Eye Scissors, Corneal Scissors

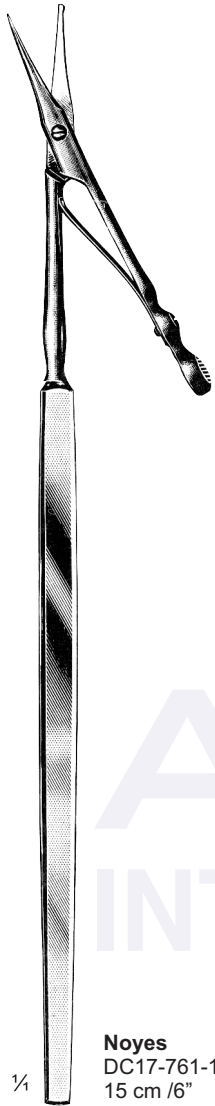
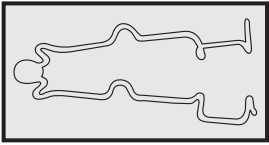

Noyes
DC17-761-15
15 cm / 6"

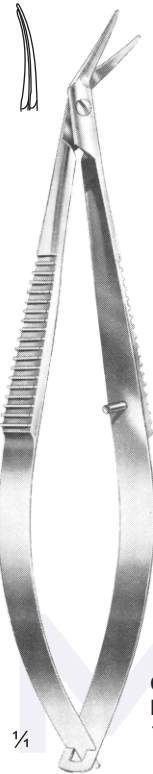

Castroviejo
DC17-763-10
10 cm / 4"

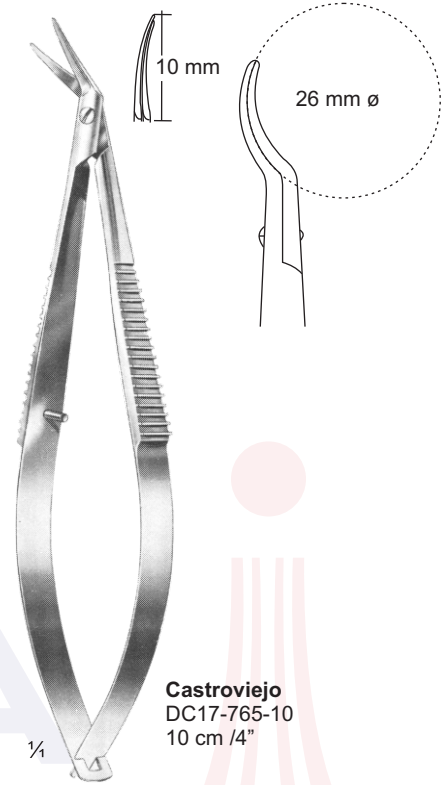

Castroviejo
DC17-765-10
10 cm / 4"

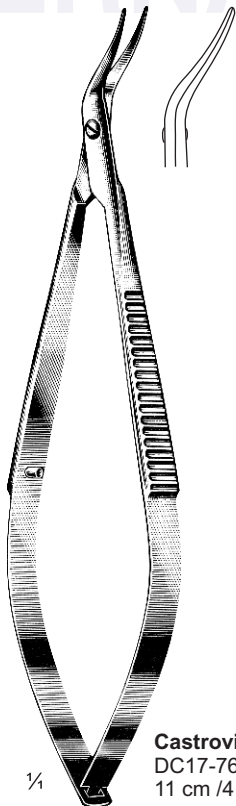

Castroviejo
DC17-767-11
11 cm / 4 1/2"

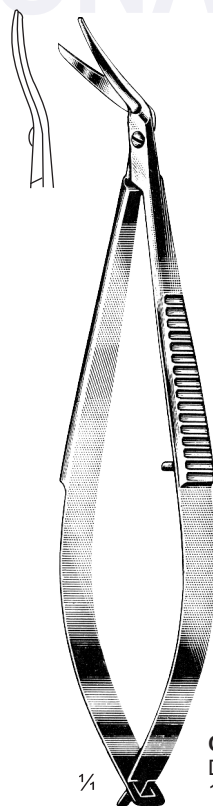

Castroviejo
DC17-769-11
11 cm / 4 1/2"

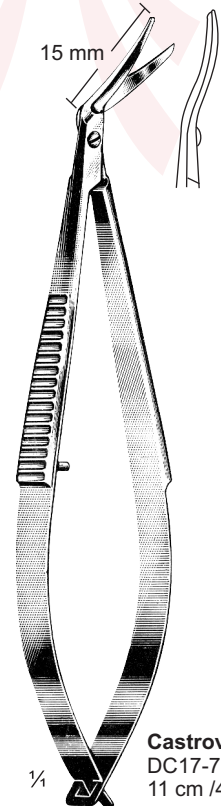

Castroviejo
DC17-771-11
11 cm / 4 1/2"

Iridectomy Scissors, Secondary Cataract Scissors
Micro and fine Eye Scissors

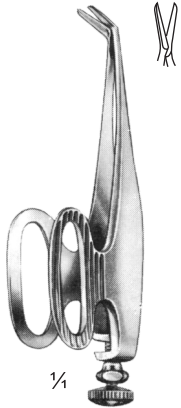
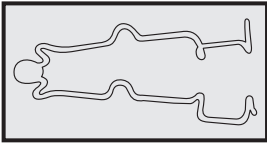

1/4

Barraquer
DC17-773-05 - 10
5.5 cm / 2 1/4"
Blatt 5 mm

Cutting Blades

DC17-773-05	5 mm
DC17-773-07	7 mm
DC17-773-10	10 mm

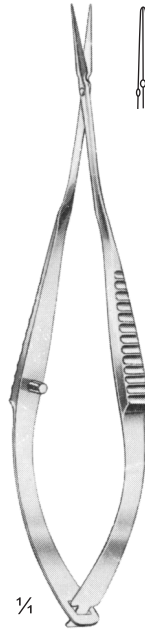

1/4

DC17-775-08
8.5 cm / 3 1/2"



1/4

DC17-777-08
8.5 cm / 3 1/2"



1/4

DC17-779-08
8.5 cm / 3 1/2"

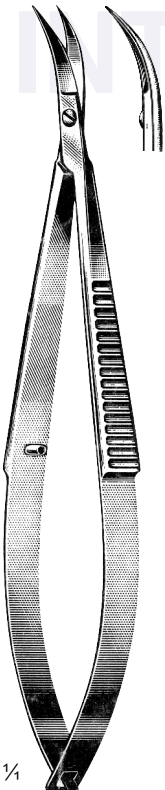

1/4

Castroviejo
DC17-781-10
10 cm / 4"

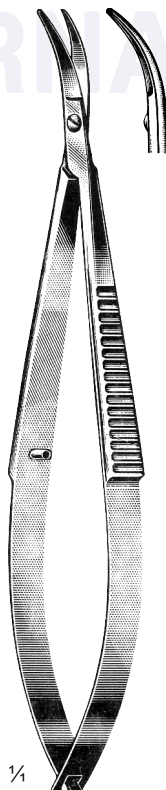

1/4

Castroviejo
DC17-783-10
10 cm / 4"

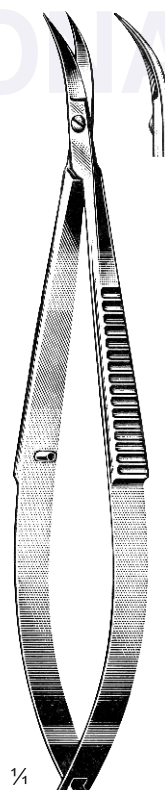

1/4

Castroviejo
DC17-785-10
10 cm / 4"

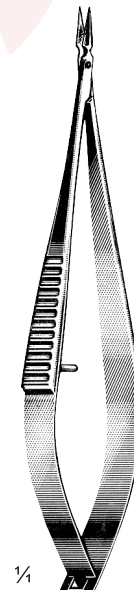

1/4

Vannas
DC17-787-08
8 cm / 3 1/4"



DC17-789-08

Micro Scissors, Keratomy Scissors

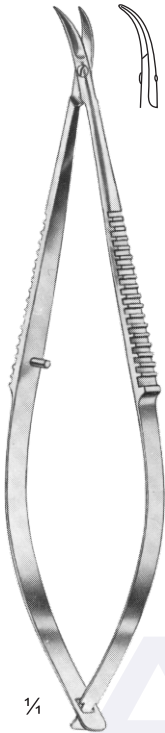
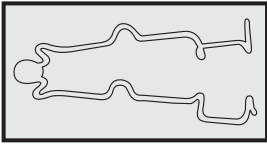

Castroviejo
DC17-791-10
10 cm / 4"

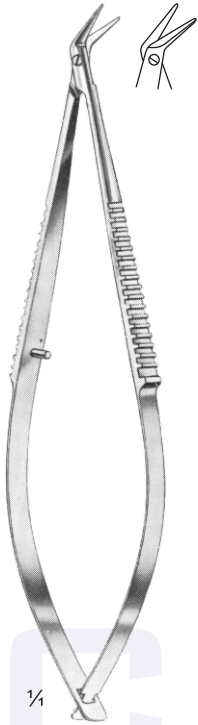

Castroviejo
DC17-793-10
10 cm / 4"

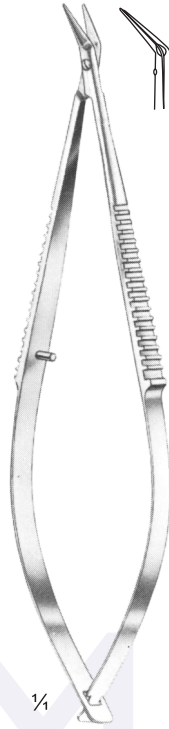

Aebli
DC17-795-10
10 cm / 4"

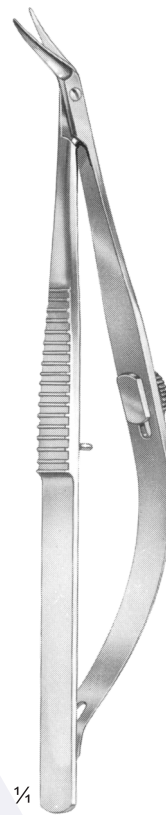

Troutman-Castroviejo
DC17-797-10
10.5 cm / 4"
right

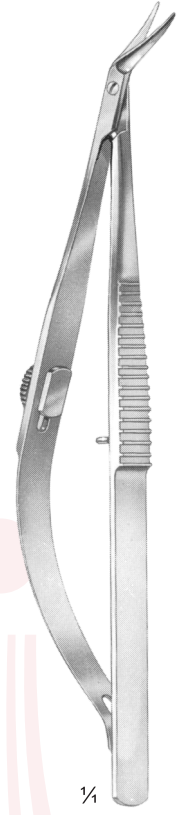

Troutman-Castroviejo
DC17-799-10
10.5 cm / 4"
left

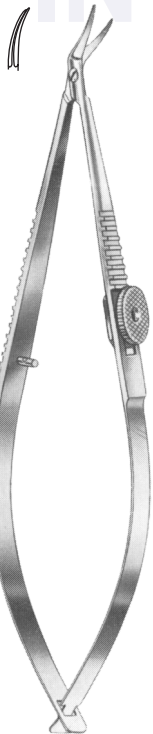

Katzin-Barraquer
DC17-801-10
10 cm / 4"
left

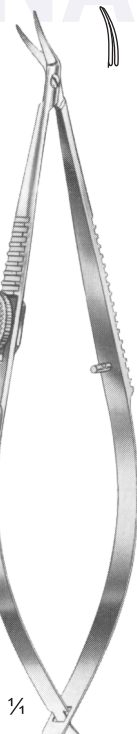

Katzin-Barraquer
DC17-803-10
10 cm / 4"
right

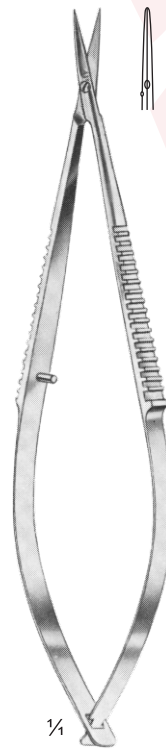

DC17-805-10
10 cm / 4"

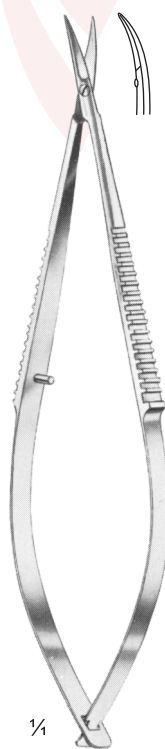

DC17-807-10
10 cm / 4"

Tenotomy, Corneal and Iris Scissors

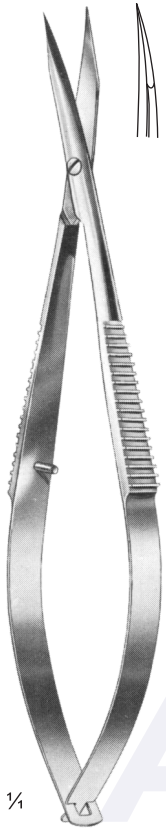
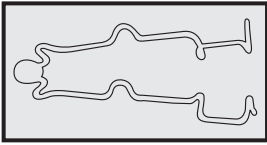

Westcott
DC17-809-11
11 cm / 4 1/2"
Pointed

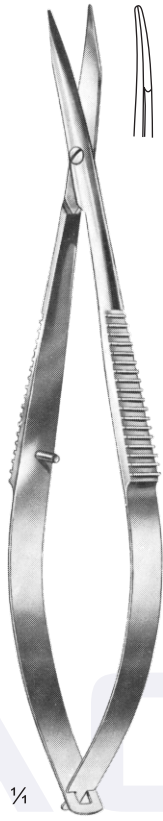

Westcott
DC17-811-11
11 cm / 4 1/2"
blunt

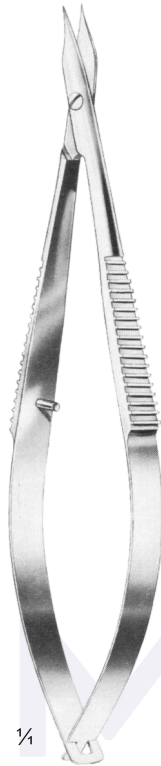

McPherson-Westcott
DC17-813-10
10 cm / 4"

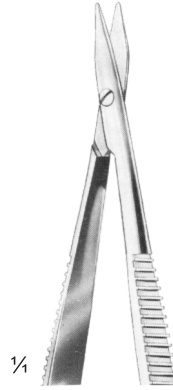

McPherson-Westcott
DC17-815-10
10 cm / 4"

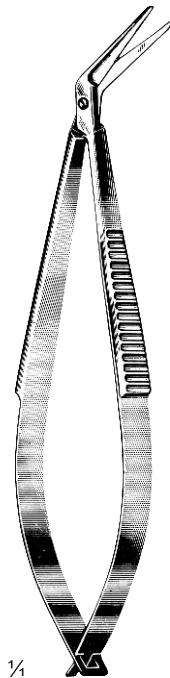

Castroviejo
DC17-817-09
9 cm / 3 1/2"

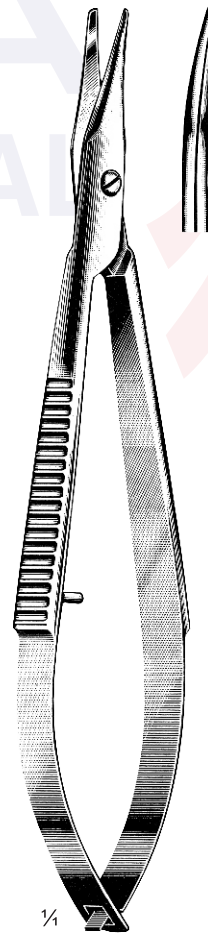

Scheie-Westcott
DC17-819-12
12 cm / 4 3/4"

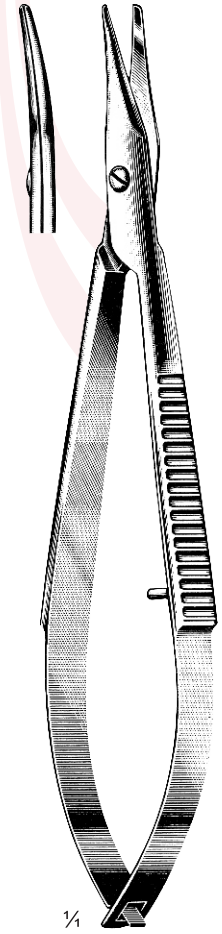

DC17-821-12

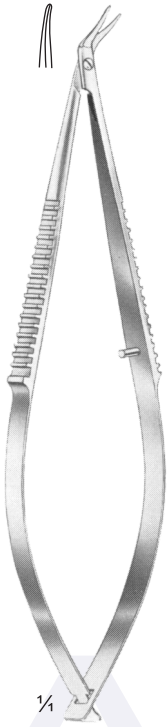
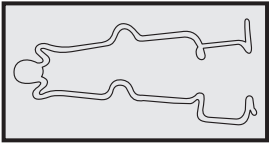

Troutman
DC17-823-10
10 cm /4"
left

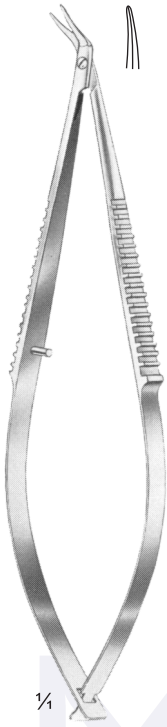

Troutman
DC17-825-10
10 cm /4"
right

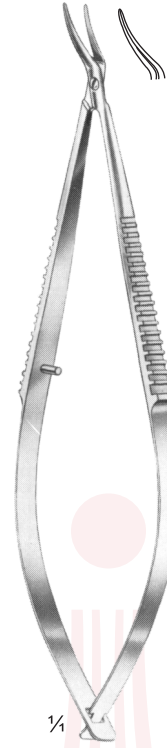

Troutman-Castroviejo
DC17-827-10
10 cm /4"

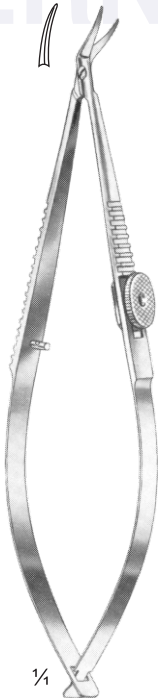

Troutman-Barraquer
DC17-829-10
10 cm /4"
left

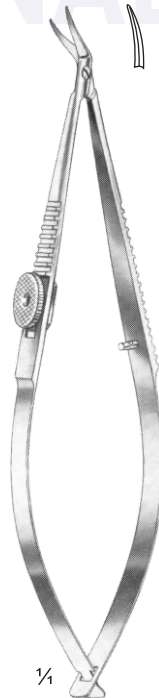

Troutman-Barraquer
DC17-831-10
10 cm /4"
right