

18

Rehnology, Otology, Mouth

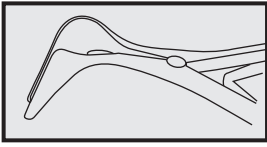



Nasal Specula

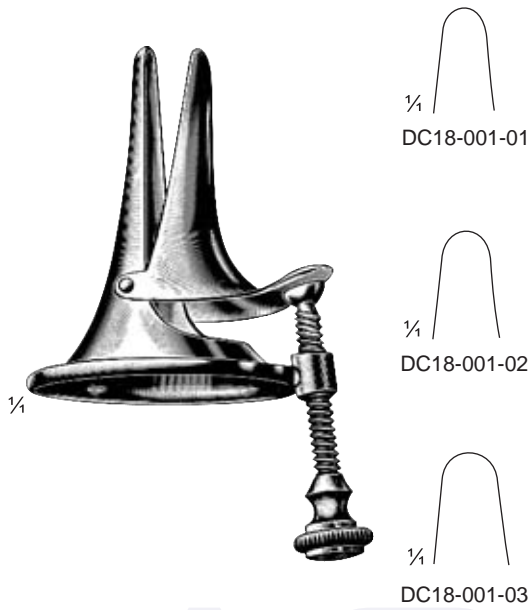

Voltolini
DC18-001-01 - DC18-001-03

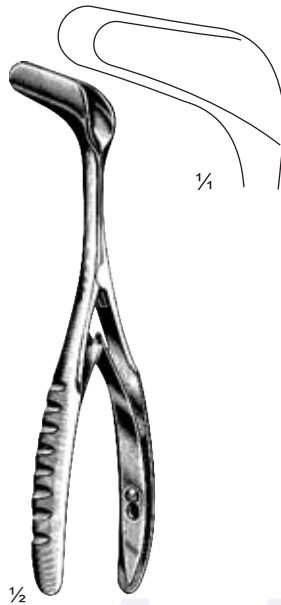

Schwarz
DC18-003-14
14 cm/5 1/2"



Hartmann-Halle
15 cm/6"

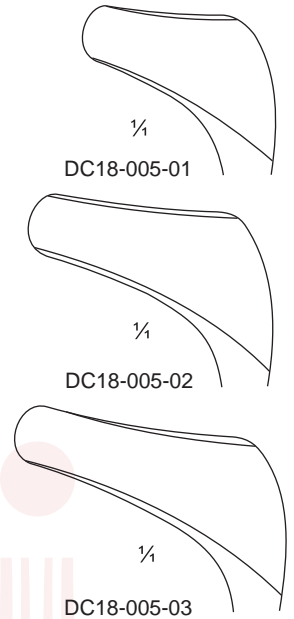

ACMA
INTERNATIONAL

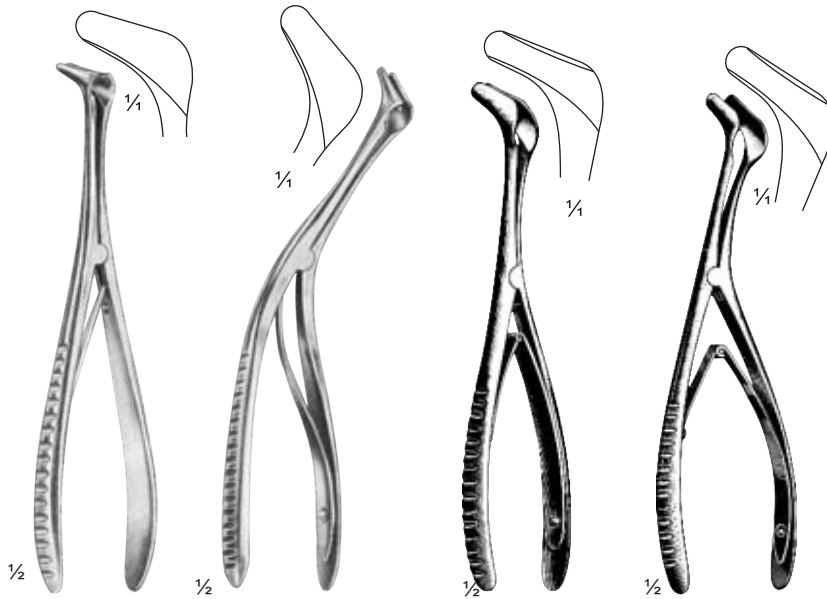

Mod. Martin
DC18-007-13
13 cm/5"
straight
for infants

Mod. Martin
DC18-009-13
13 cm/5"
curved
for infants

Tieck-Halle
DC18-011-13
13.5 cm/5 1/4"
for children

Tieck-Halle
DC18-013-13
13.5 cm/5 1/4"
for children



Killian
13 cm/5"
nasal and nasopharyngeal

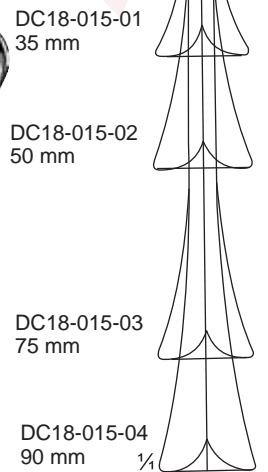

Nasal Specula

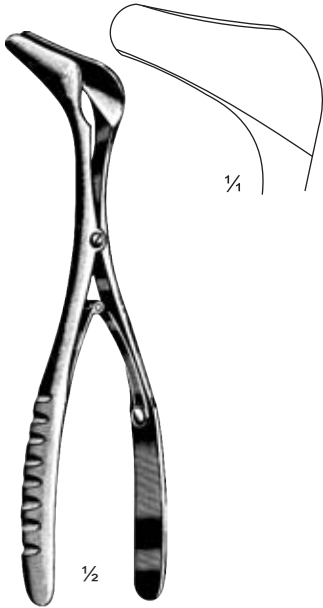
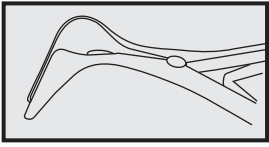

Mod. Wein
DC18-017-14
14.5 cm/5 3/4"



Cottle
14 cm/5 1/2"

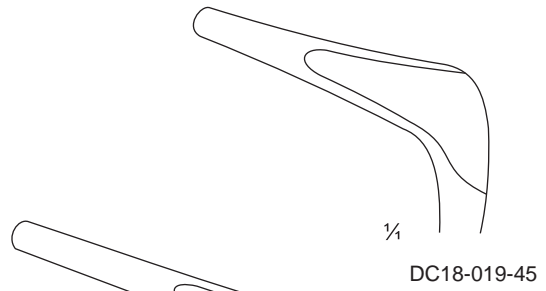

DC18-019-45

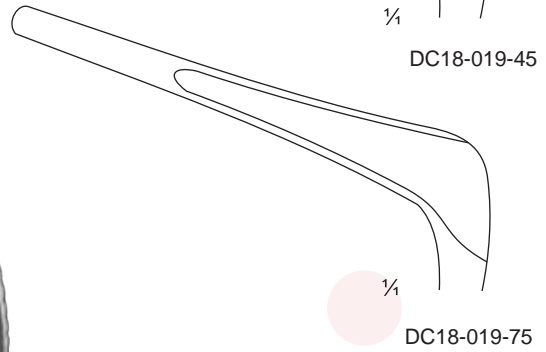

DC18-019-75

Dull black chromium plated



Cottle
DC18-021-35-90
15 cm/6"

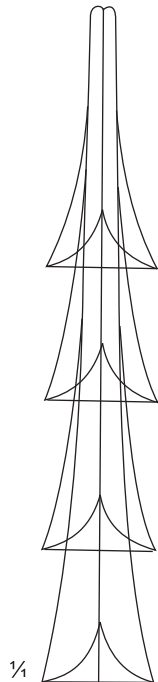

1/4

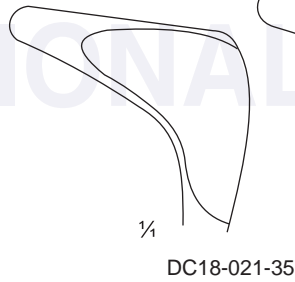

DC18-021-35

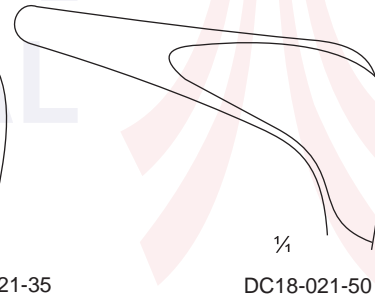

DC18-021-50

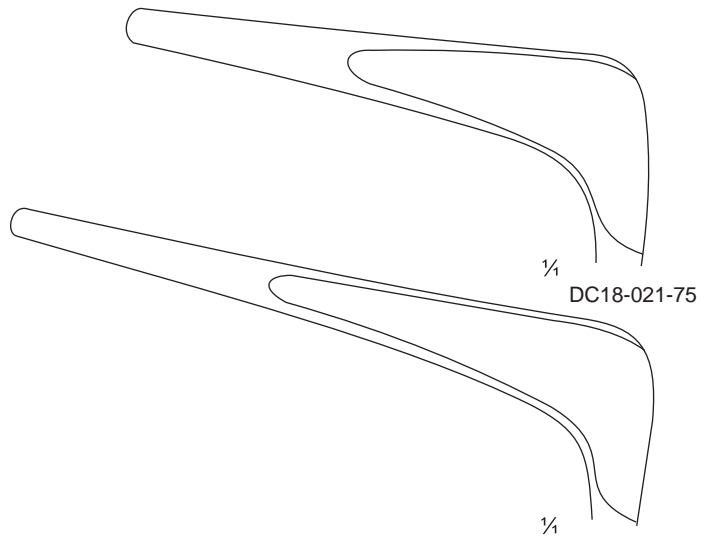

DC18-021-75

DC18-021-90

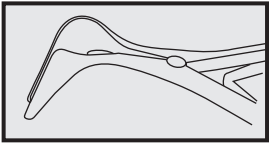

Tampon Forceps, Nasal Polypus Forceps

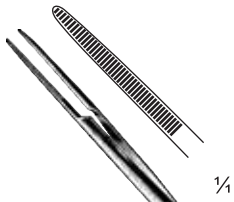

1/4

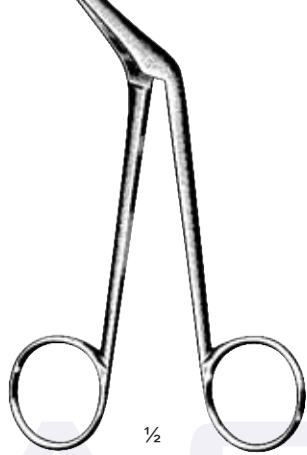

1/2

Westmacott
DC18-023-20
Nasal Polypus Forceps



1/2

Lubet-Barbon
DC18-025-20
Nasal Polypus Forceps



1/4

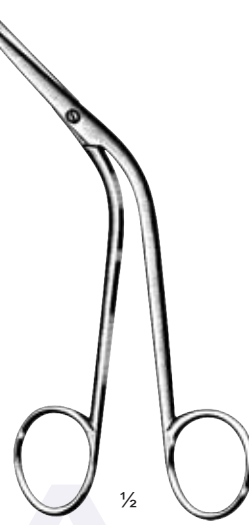

1/2

Hartmann
DC18-027-16
16 cm/6 1/4"
Nasal Polypus Forceps

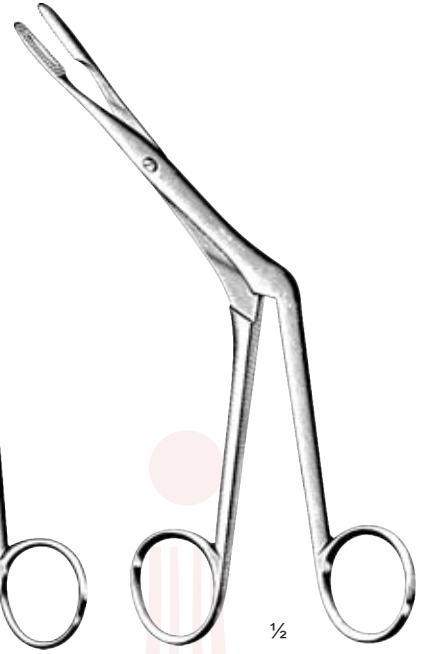

1/2

Hartmann-Knight
DC18-029-18
18 cm/7"
Nasal Polypus Forceps



1/4

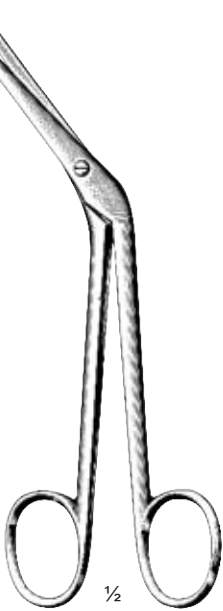

1/2

Hartmann
DC18-031-20
20 cm/8"
Nasal Polypus Forceps



1/4



1/2

Littauer
DC18-033-18
18 cm/7"
Nasal Polypus Forceps

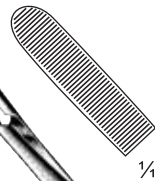

1/4

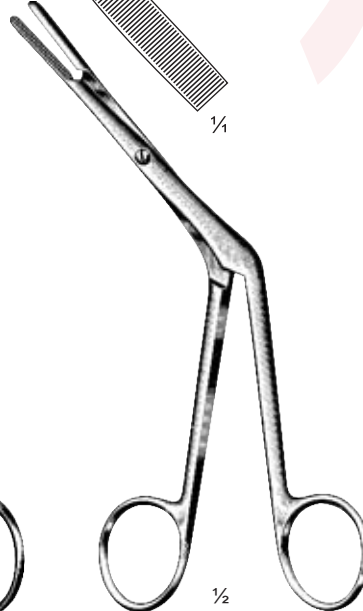

1/2

Killian
DC18-035-17
17 cm/6 3/4"
Septum Compression Forceps

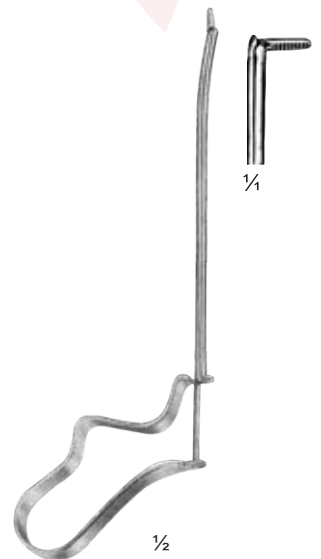

1/4

Quire
DC18-037-12
12 cm/4 3/4"
Foreign Body Forceps

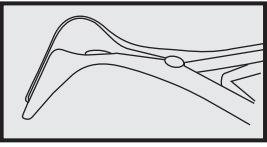

Nasal Cutting, Ethmoid and Septum Compression Forceps

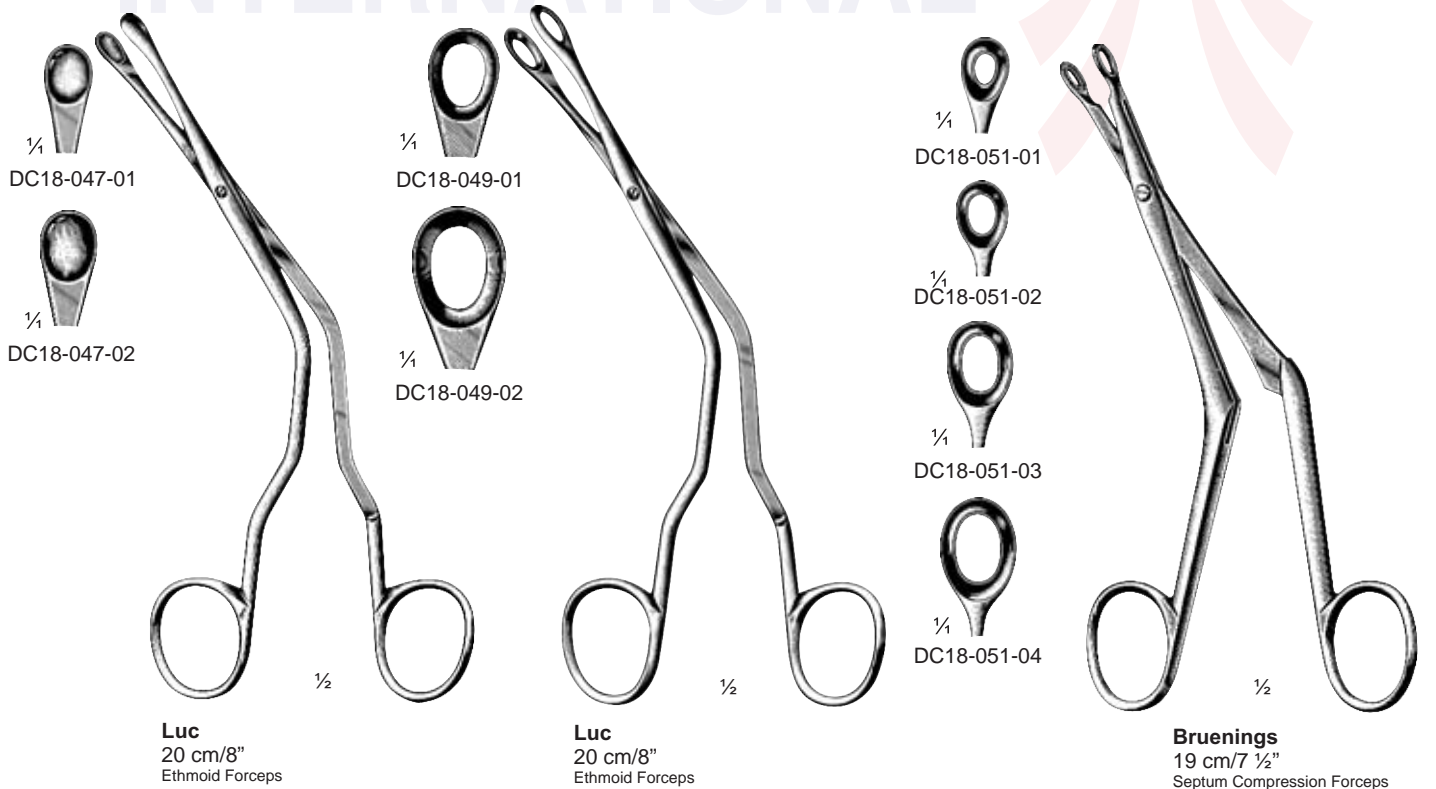
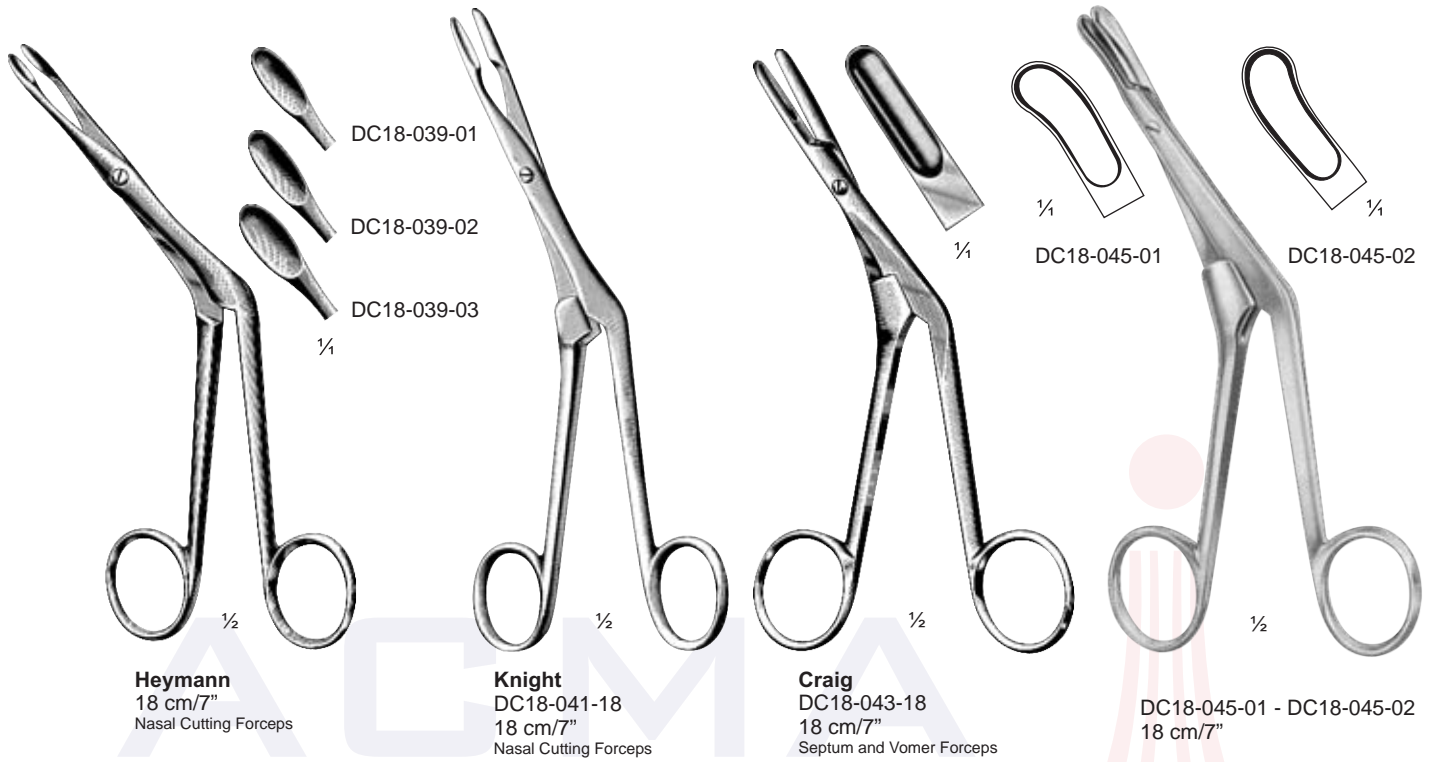

Ethmoid and Nasal Cutting Forceps

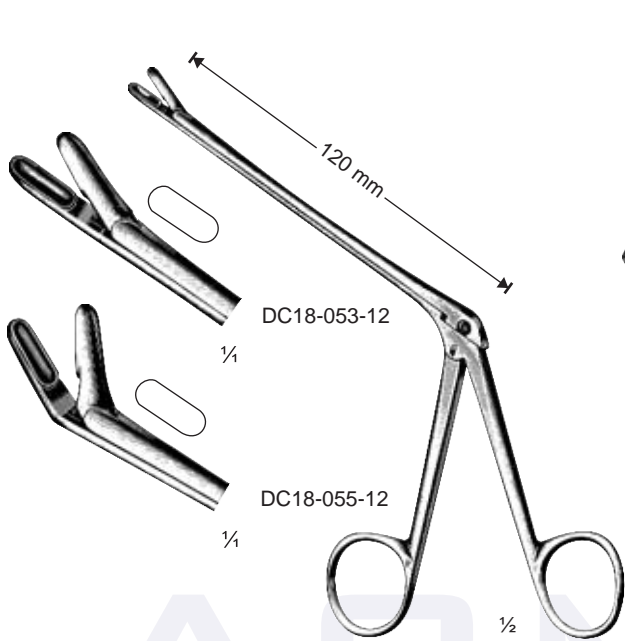
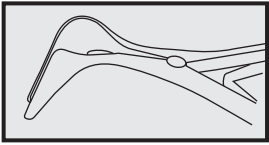

Takahashi
19 cm/7½"
Ethmoid Forceps

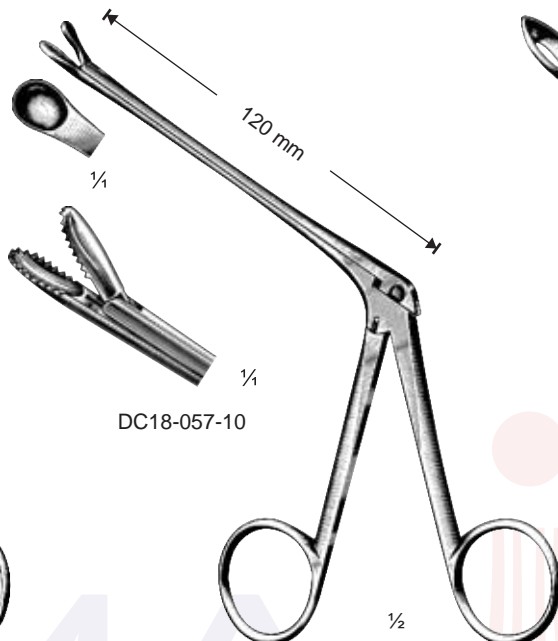

Watson-Williams
DC18-057-12
19 cm/7½"
Ethmoid Forceps

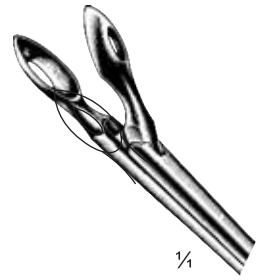

Weil
DC18-059-12
19 cm/7½"
Nasal Cutting Forceps

ACMA
INTERNATIONAL

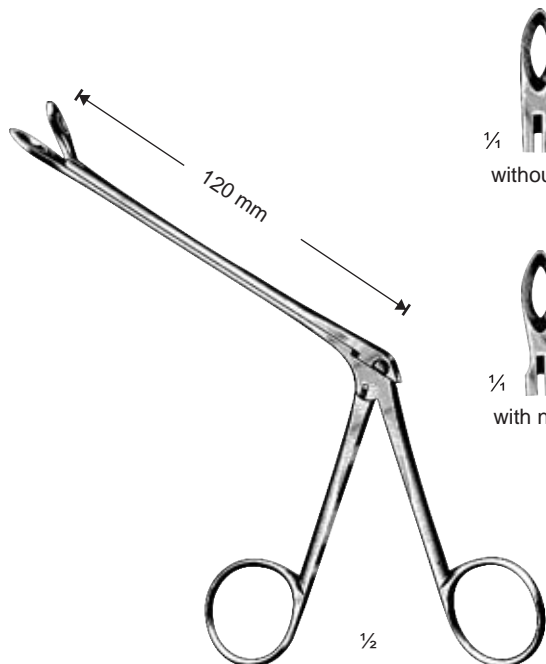

Weil-Blakesley
19 cm/7 ½"
Nasal Cutting Forceps

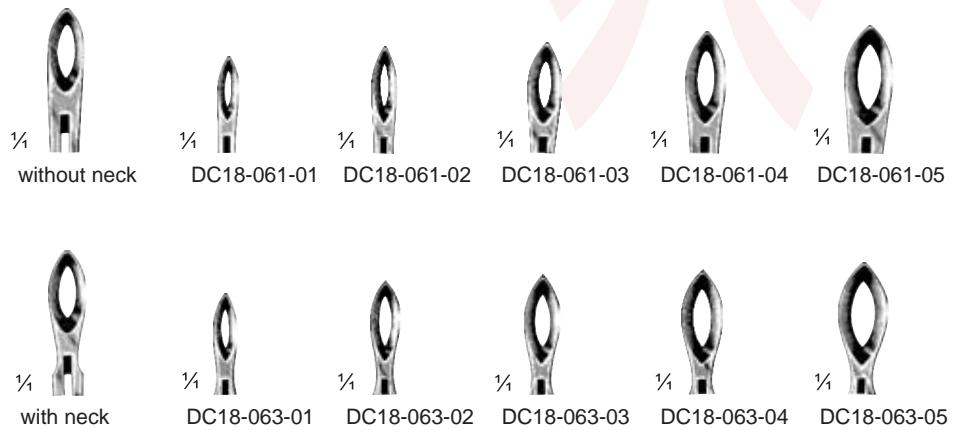

Nasal Cutting Forceps, Sphenoid Punches and Rongeur Forceps

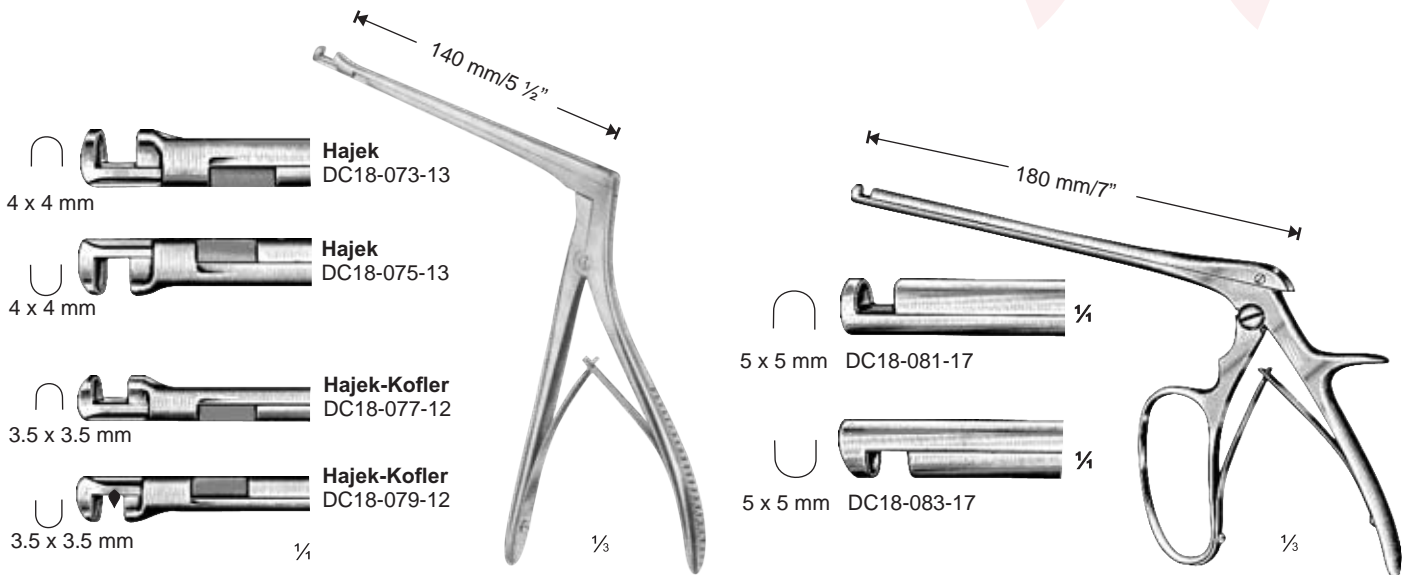
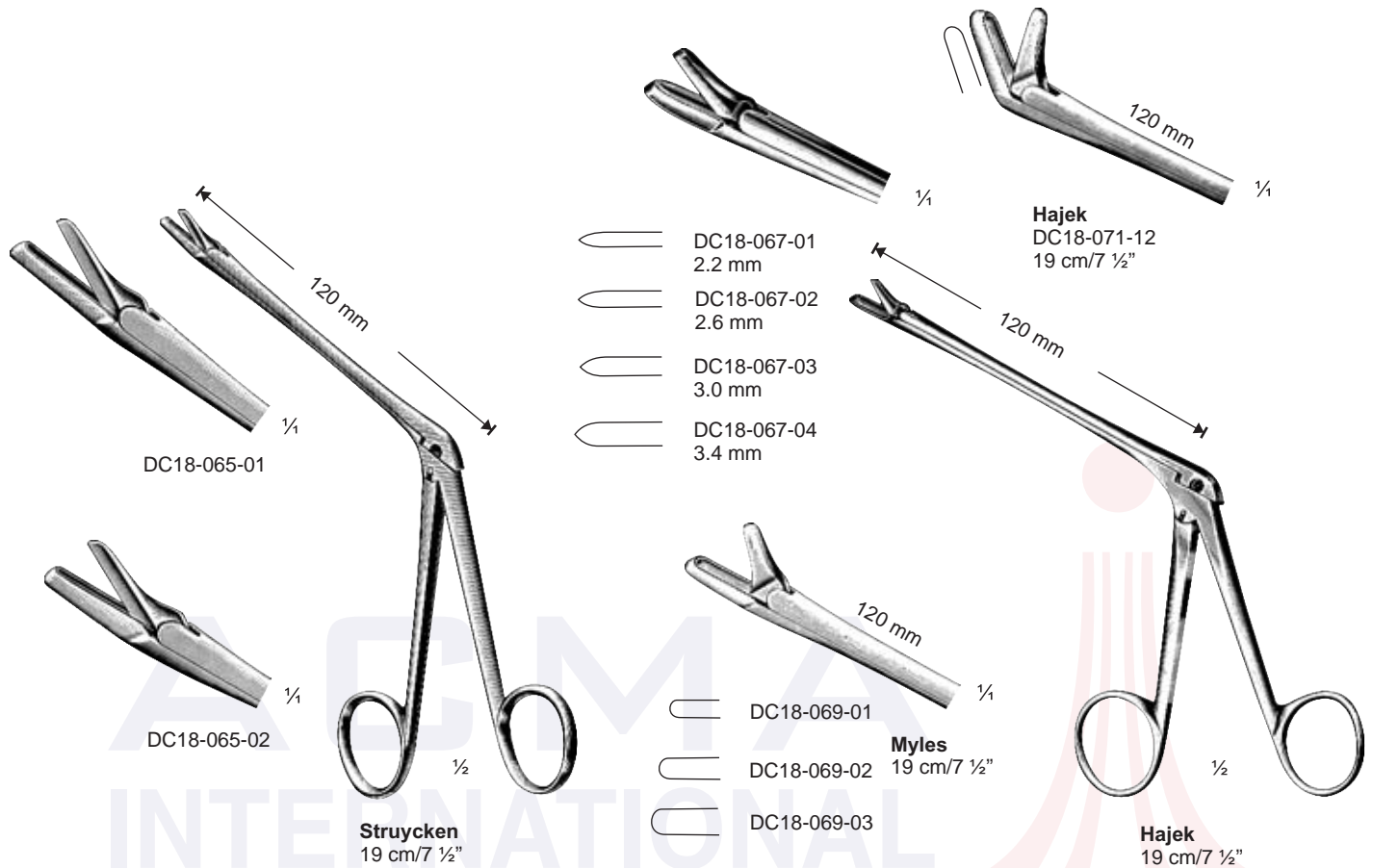
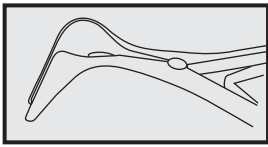

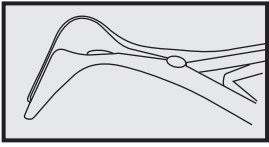

Antrum Punch Forceps, Adenoid Cutting Forceps



Hajek-Claus
DC18-085-20
20 cm/8"

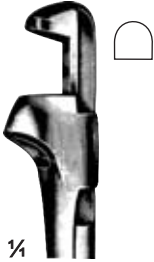

1/4



Jurasz
22 cm/8 3/4"
Adenoid Cutting Forceps,
fenestrated jaws



DC18-087-01



DC18-087-02



DC18-087-03



Chatellier
22 cm/8 3/4"
Adenoid Cutting Forceps,
fenestrated jaws,
spoon-shaped jaws



DC18-089-01



DC18-089-02



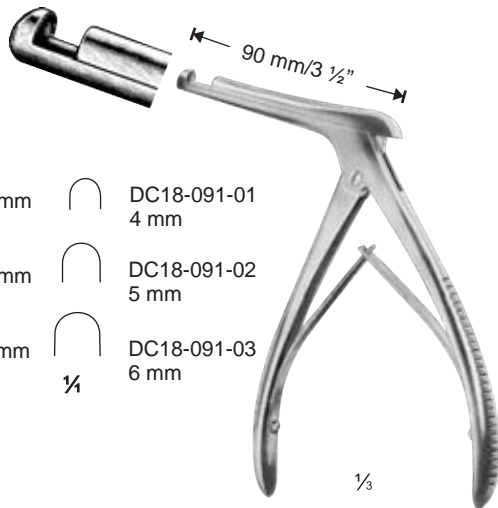

DC18-089-03

ACMA
INTERNATIONAL





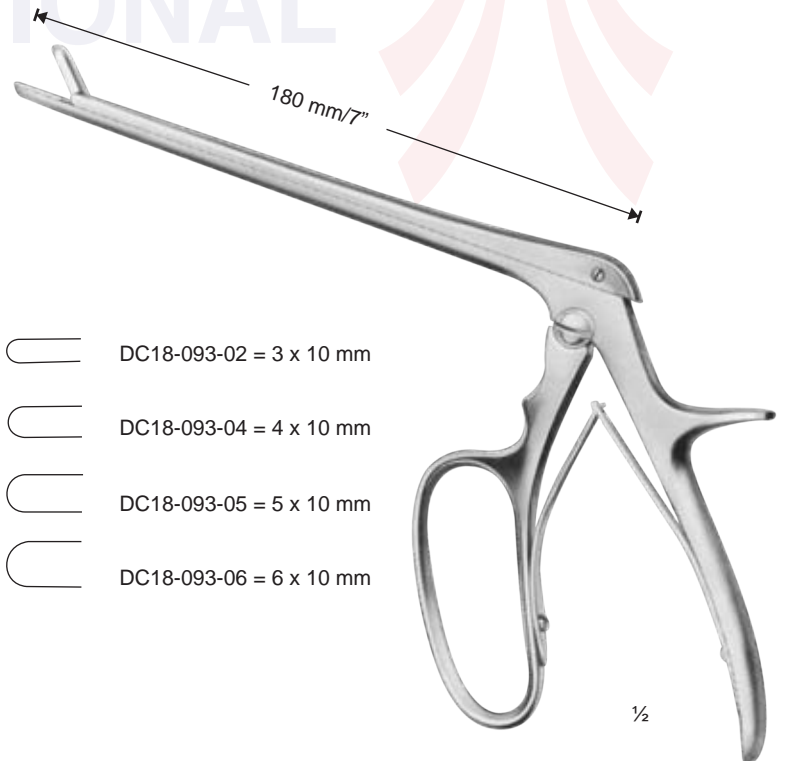

90 mm/3 1/2"

- 4 x 4 mm  DC18-091-01
4 mm
- 5 x 5 mm  DC18-091-02
5 mm
- 6 x 6 mm  DC18-091-03
6 mm

Kerrison
20 cm/8"
Antrum Rongeur Forceps,
not-through cutting



180 mm/7"

-  DC18-093-02 = 3 x 10 mm
-  DC18-093-04 = 4 x 10 mm
-  DC18-093-05 = 5 x 10 mm
-  DC18-093-06 = 6 x 10 mm

Ferris Smith-Cushing
Sphenoid Nibble Forceps

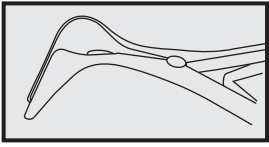

Dressing Forceps and Nasla Snares



Troeltsch
DC18-095-15
15 cm/6"

Troeltsch
DC18-097-18
18 cm/7"



Gruenwald (Jansen)
DC18-099-20
20 cm/8"

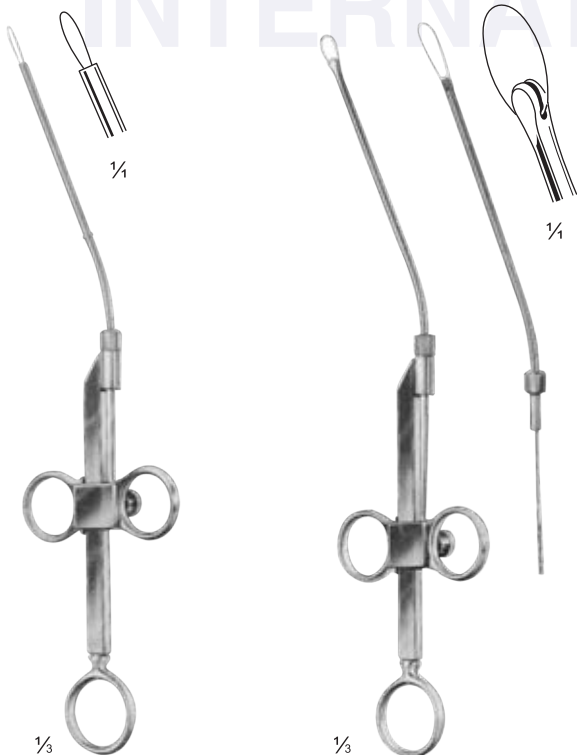

Krause
DC18-101-26
with 1 cannula

Krause-Voss
DC18-103-26
with 2 cannula



Lange-Wilde
DC18-105-24
with 1 cannula

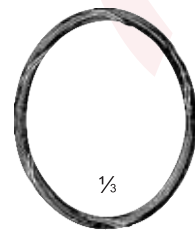

DC18-107-30 = 0.3 mm ø
DC18-107-40 = 0.4 mm ø
10 m/33 ft.
Steel Wire for nasal snares, in coils



DC18-109-12
0.3 mm ø
Steel Wire Loops, shaped,
in bundles of 1 dozen each

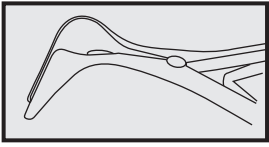

Rhinoplastic Instruments etc.

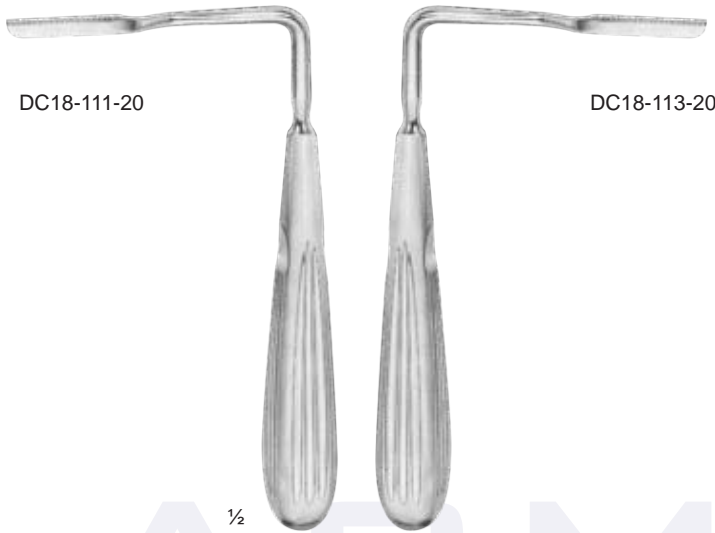

DC18-111-20

DC18-113-20

1/2

Joseph
Nasal Saws, right-angled

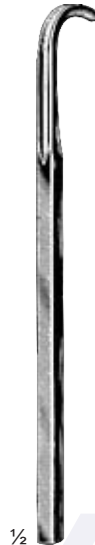

1/2

Joseph
DC18-115-15
Nasal Saw Protector and Guide

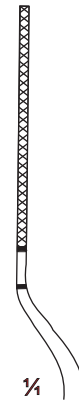

1/4

DC18-117-01

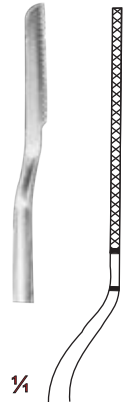

1/4

DC18-117-02

1/2

Joseph
DC18-117-01 - DC18-117-02
19 cm/7 1/2"
Nasal Saw, bayonet shaped

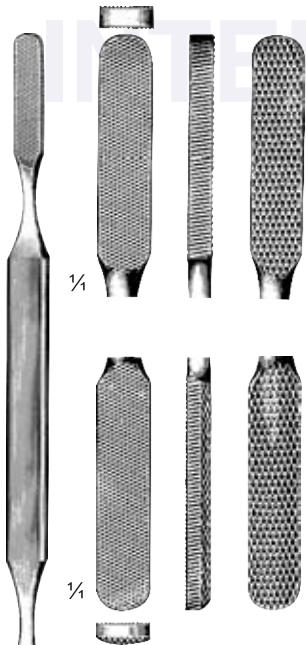

1/4

1/4

1/2

Fomon
DC18-119-21
21 cm/8 1/4"
Nasal Rasp, double-ended

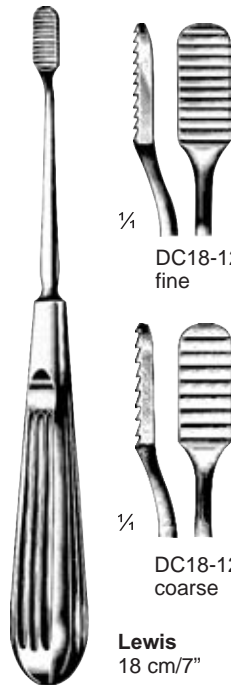

1/4

DC18-121-18
fine

1/4

DC18-123-18
coarse

1/2

Lewis
18 cm/7"

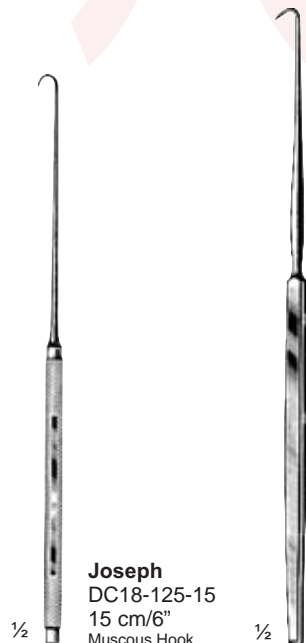

1/2

Joseph
DC18-125-15
15 cm/6"
Muscous Hook

1/2

Cottle
DC18-127-16
16 cm/6 1/4"

Septum Knives, Currettes Tranchantes

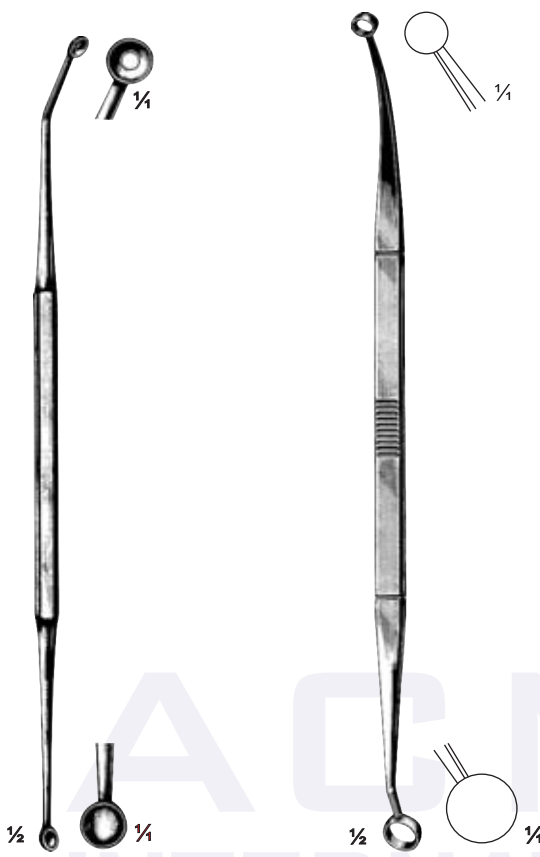
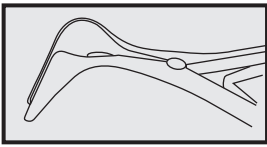

Pratt
DC18-129-21
21 cm/8 1/4"

Faulkner
DC18-131-21
21 cm/8 1/4"

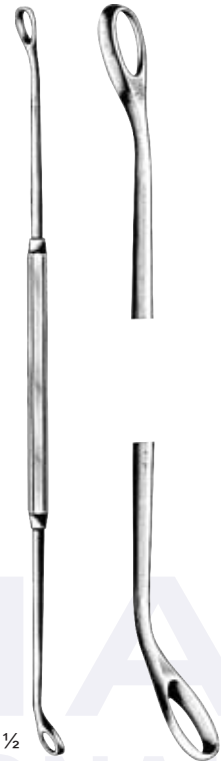

DC18-133-12

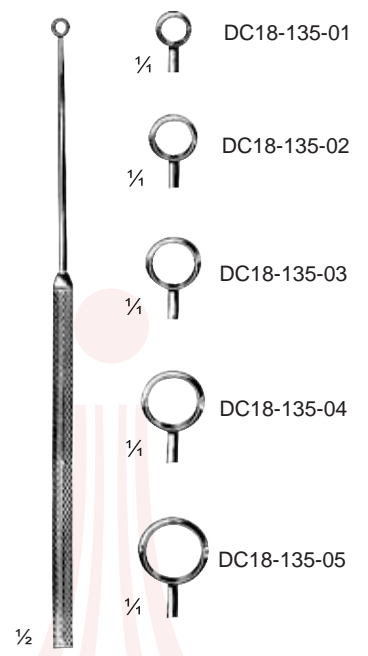

Myles
17 cm/6 3/4"
malleable

DC18-135-01

DC18-135-02

DC18-135-03

DC18-135-04

DC18-135-05

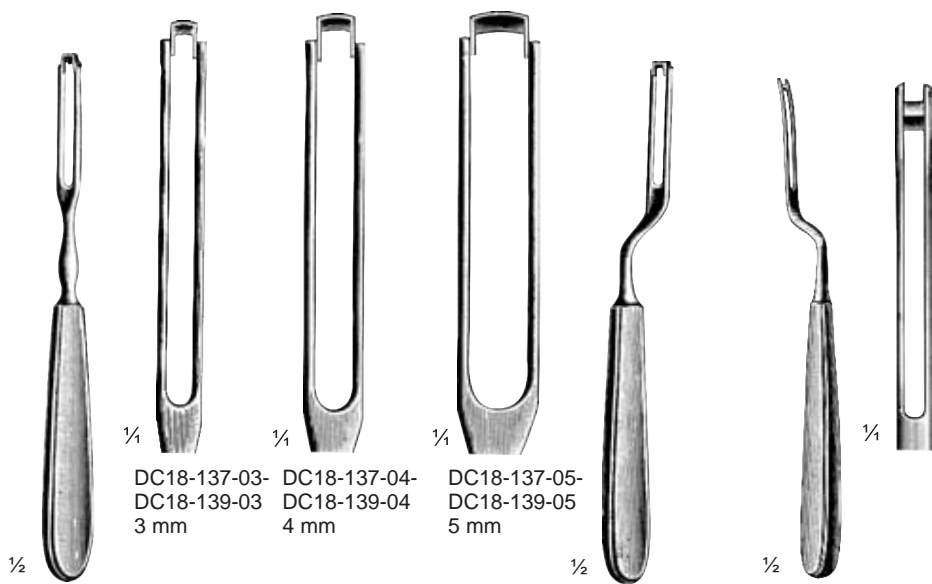

Ballenger
DC18-137-03-
DC18-137-05
Septum Swivel Knives

Ballenger
DC18-139-03-
DC18-139-05
Septum Swivel Knives

Killian
DC18-141-03
3 mm
Septum Swivel Knives

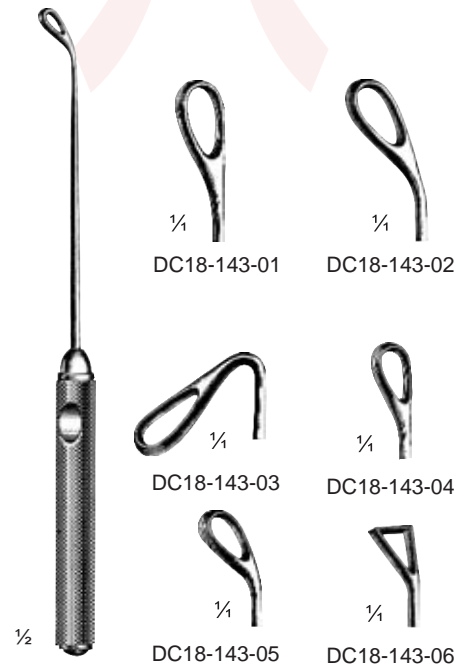

Coakley
17 cm/6 3/4"

DC18-143-01

DC18-143-02

DC18-143-03

DC18-143-04

DC18-143-05

DC18-143-06

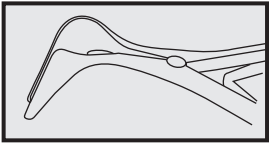

Adenoid Currettes

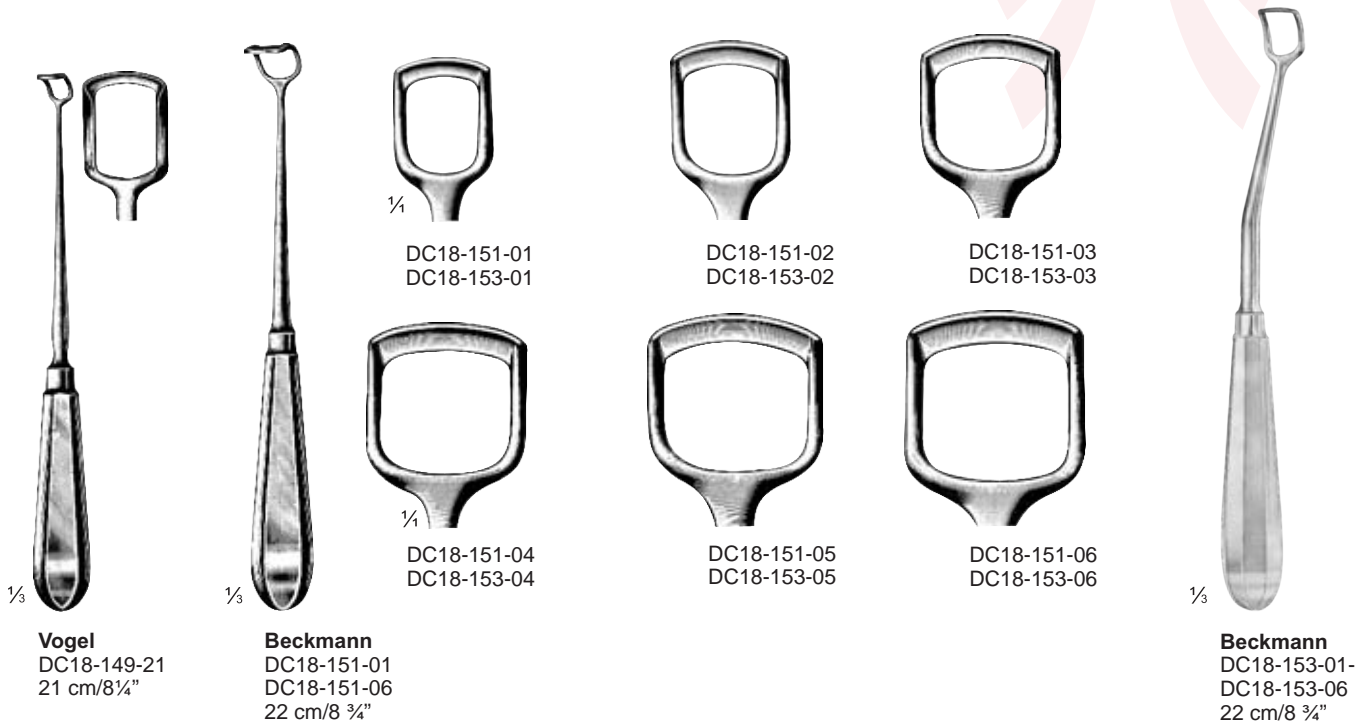
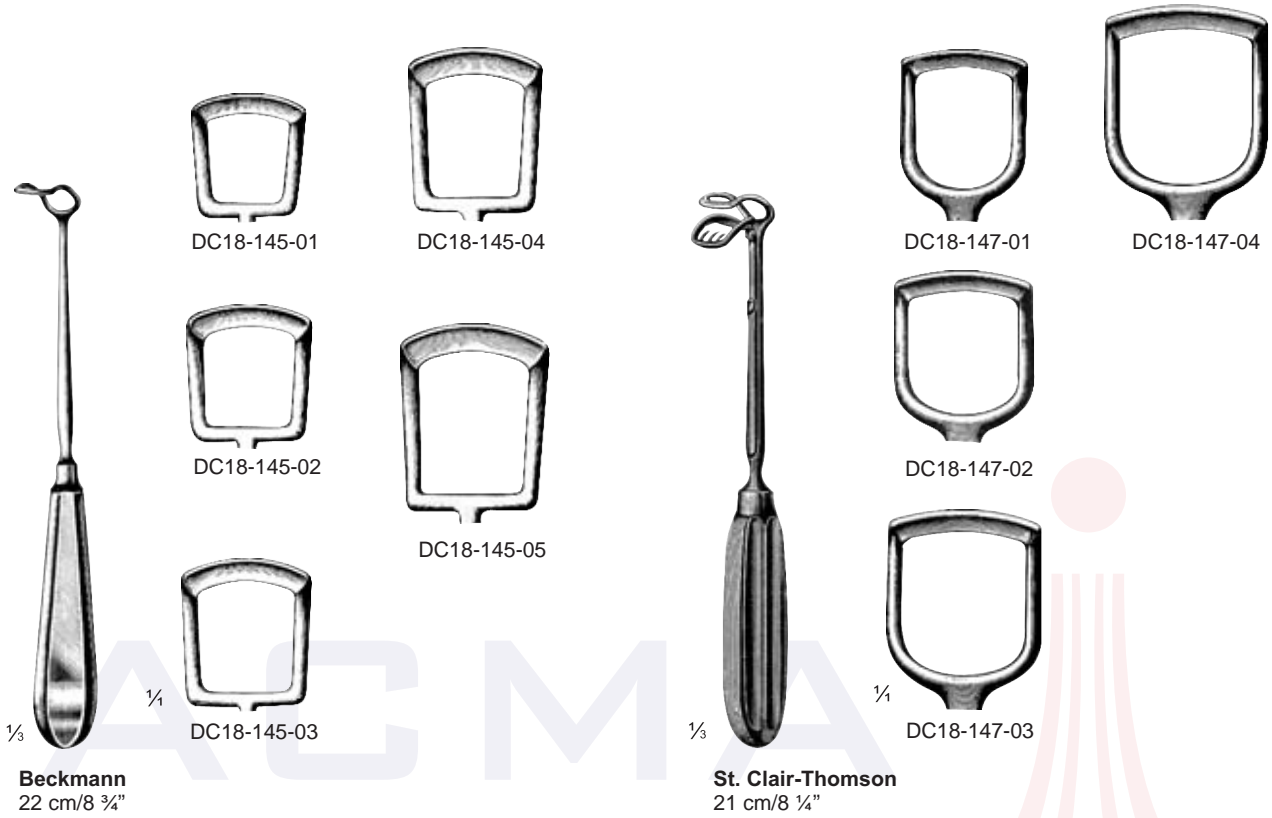

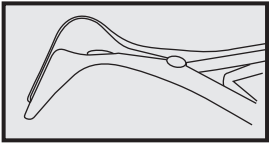

Rhinoplastic Instruments etc.,
Antrum and Frontal Sinus Wash Cannulas

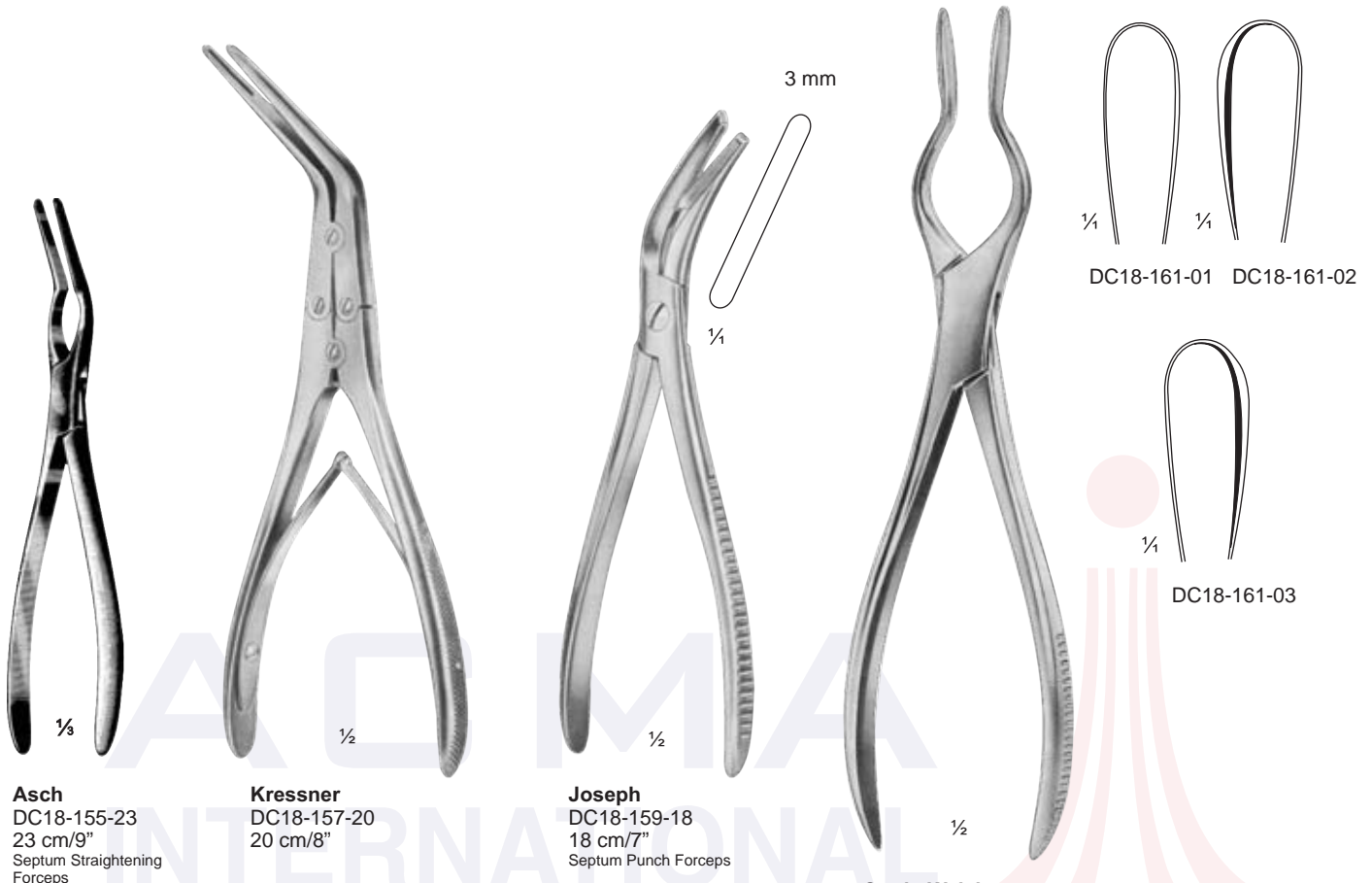

Asch
DC18-155-23
23 cm/9"
Septum Straightening
Forceps

Kressner
DC18-157-20
20 cm/8"

Joseph
DC18-159-18
18 cm/7"
Septum Punch Forceps

Cottle-Walsham
DC18-161-01 - DC18-161-03
23 cm/9"
Septum Straightening Forceps



Ogura
DC18-163-11
Tissue Forceps

Cottle
DC18-165-14
Tissue Forceps

Hajek
DC18-167-15 = 1.5 mm ø
DC18-167-20 = 2.0 mm ø

Hartmann
DC18-169-20 = 2.0 mm ø
DC18-169-25 = 2.5 mm ø
DC18-169-30 = 3.0 mm ø

Myles
1.8 mm ø
DC18-171-09 = 9 cm/3 1/2"
DC18-171-10 = 10 cm/4"
DC18-171-11 = 11.5 cm/4 1/2"

Hartmann
Fig. 1 mm ø Fig. 2
DC18-173-20 2.0 DC18-175-20
DC18-173-25 2.5 DC18-175-25
DC18-173-30 3.0 DC18-175-30

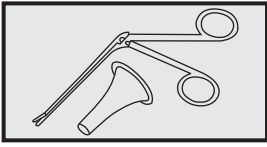

Ear Specula

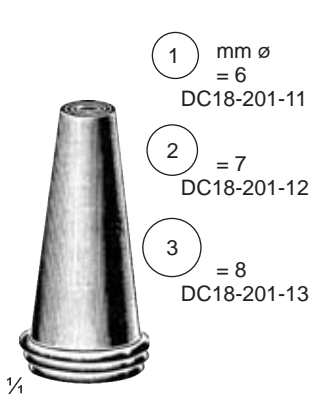

Troeltsch
for adults
Set of 3
Fig. 1-3 DC18-201-03

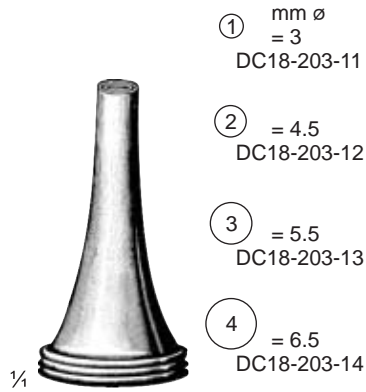

Poltzer
for adults
Set of 3
Fig. 2-4 DC18-203-03
Set of 4
Fig. 1-4 36-105-04



Hartmann
DC18-205-10
for babies

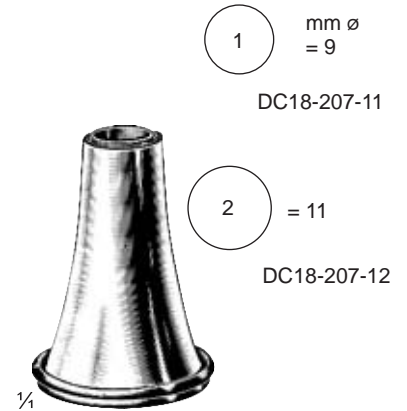

Hartmann
for postoperative treatment
Set of 2
Fig. 1-2 DC18-207-02

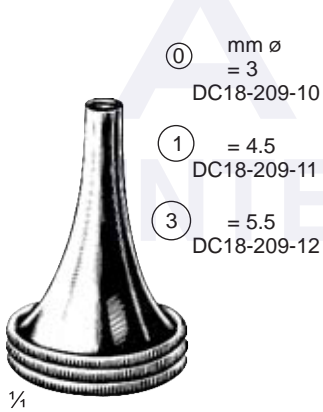

Hartmann
for children
Set of 3
Fig. 0-2 DC18-209-00



Hartmann
for adults
Set of 3
Fig. 2-4 DC18-213-03
Set of 4
Fig. 1-4 DC18-215-04



Toynbee
for adults
Set of 3
Fig. 2-4 DC18-219-03
Set of 4
Fig. 1-4 DC18-221-04



Hartmann
DC18-223-11
for children

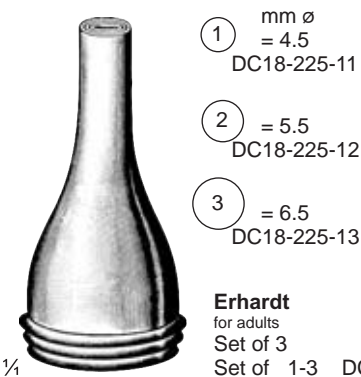

Erhardt
for adults
Set of 3
Set of 1-3 DC18-225-03

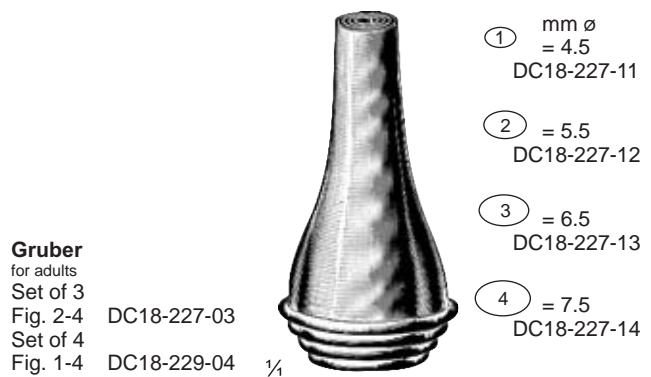

Gruber
for adults
Set of 3
Fig. 2-4 DC18-227-03
Set of 4
Fig. 1-4 DC18-229-04

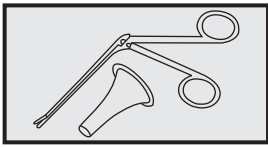

Eustachian Catheters, Ear Polypus Snares

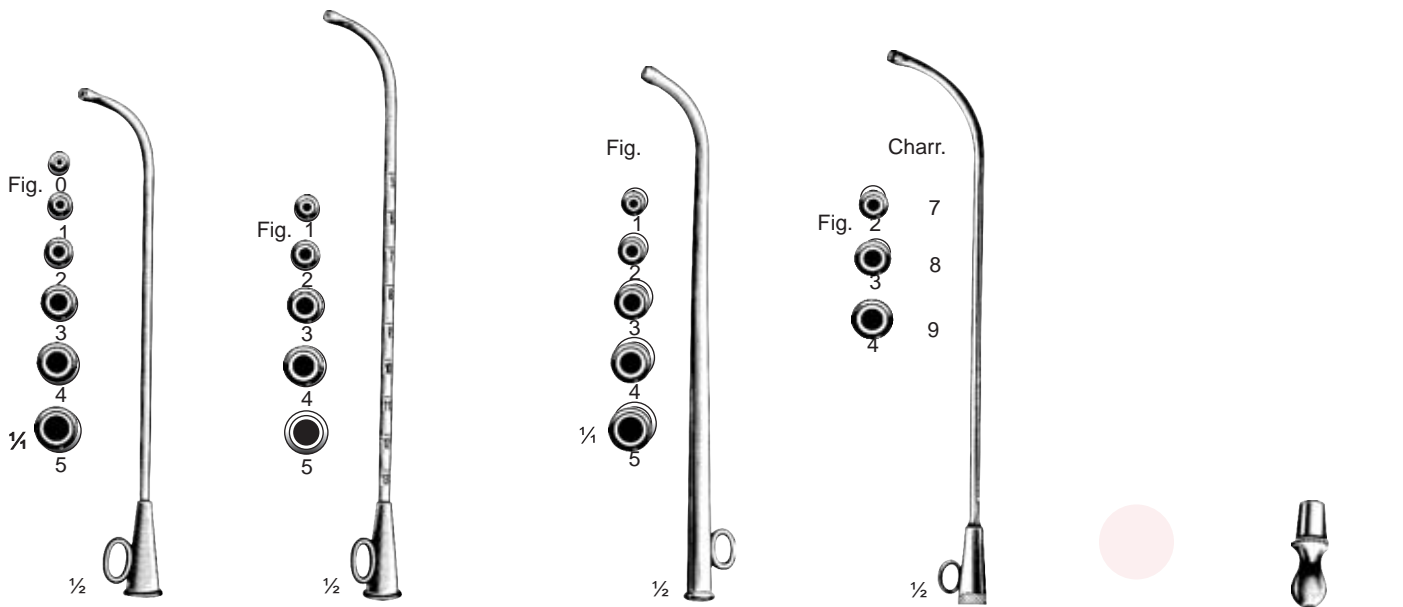
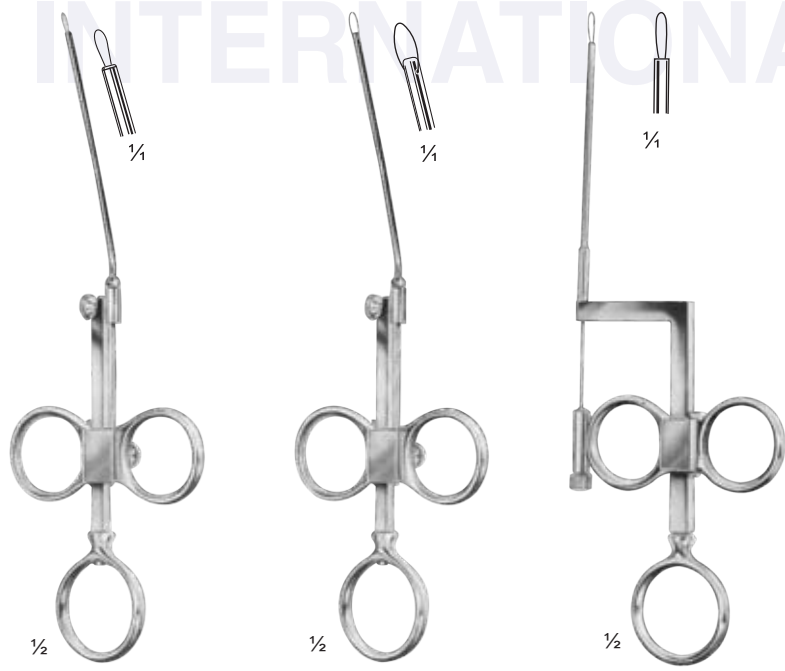

Fig.	Hartmann	Troeltsch
0	DC19-231-00	
1	DC19-231-01	DC19-233-01
2	DC19-231-02	DC19-233-02
3	DC19-231-03	DC19-233-03
4	DC19-231-04	DC19-233-04
5	DC19-231-05	DC19-233-05

Fig.	Itard	Hartmann	Charriere
1	DC19-235-01		
2	DC19-235-02	DC19-237-02	7
3	DC19-235-03	DC19-237-03	8
4	DC19-235-04	DC19-237-04	9
5	DC19-235-05		

DC19-239-00



Krause
DC19-241-16

Krause-Voss
DC19-243-16

Lange-Wilde
DC19-245-17



mm ø	
0.3	DC19-247-30
0.4	DC19-247-40



mm ø	
0.2	DC19-249-20
0.3	DC19-249-30

DC19-231-00 - DC19-237-04 - Eustachian Catheters
 DC19-241-16 - DC19-245-17 - Ear Polypus Snares
 DC19-247-30 - DC19-247-40 - Steel Wire for ear snares
 DC19-247-20, DC19-249-30 - Steel Wire Loops for ear snares, shaped, in bundles of 1 dozen each

Ear Dressing Forceps, Ear polypus Forceps, Foreign Body Levers

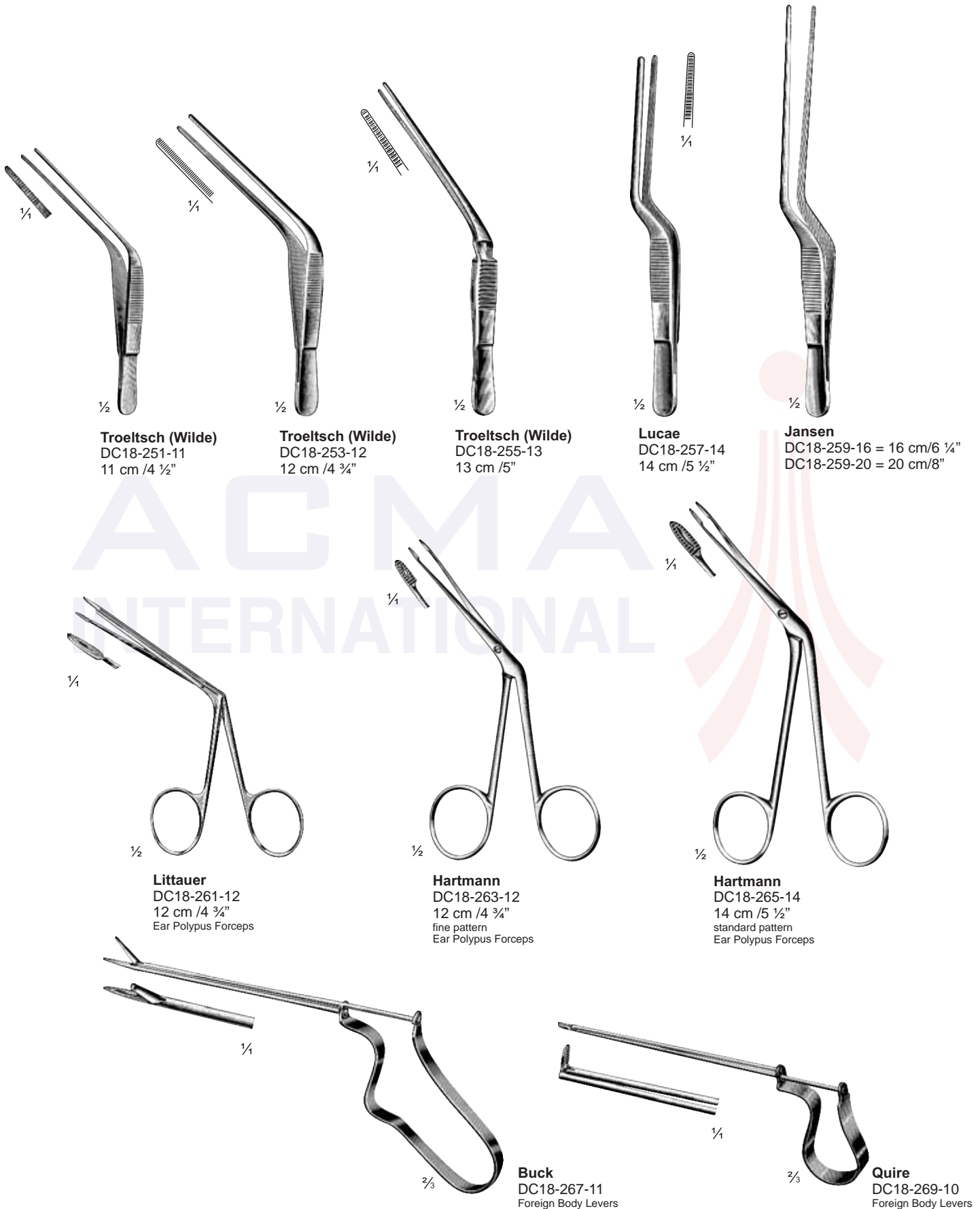
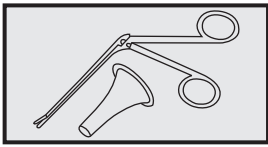

Troeltsch (Wilde)
DC18-251-11
11 cm / 4 1/2"

Troeltsch (Wilde)
DC18-253-12
12 cm / 4 3/4"

Troeltsch (Wilde)
DC18-255-13
13 cm / 5"

Lucae
DC18-257-14
14 cm / 5 1/2"

Jansen
DC18-259-16 = 16 cm / 6 1/4"
DC18-259-20 = 20 cm / 8"

Littauer
DC18-261-12
12 cm / 4 3/4"
Ear Polypus Forceps

Hartmann
DC18-263-12
12 cm / 4 3/4"
fine pattern
Ear Polypus Forceps

Hartmann
DC18-265-14
14 cm / 5 1/2"
standard pattern
Ear Polypus Forceps

Buck
DC18-267-11
Foreign Body Levers

Quire
DC18-269-10
Foreign Body Levers

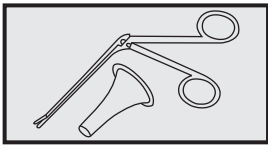

Ear Polypus Forceps

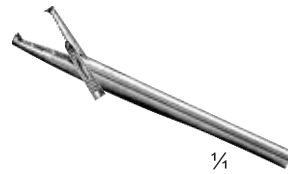
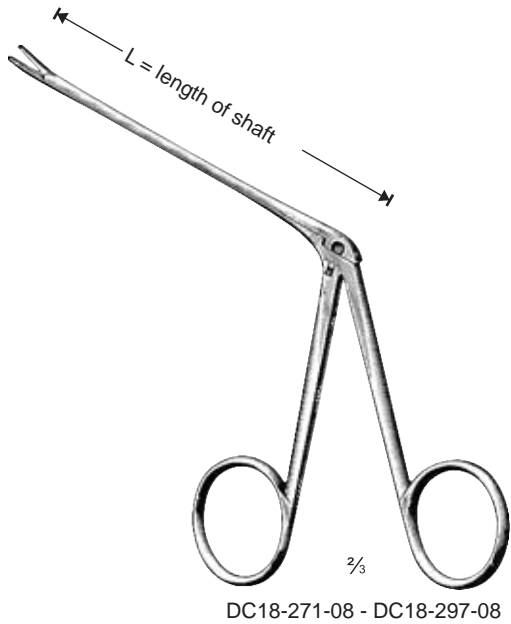

Hartmann
1 : 2

cm	in.	
8.5	3 1/2	DC18-271-08
14	5 1/2	DC18-271-14

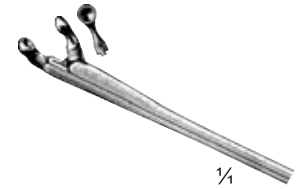

Hartmann

cm	in.	mm ø	
8.5	3 1/2	2	DC18-273-81
8.5	3 1/2	2.5	DC18-273-82
8.5	3 1/2	3	DC18-273-83



Hartmann

cm	in.	
8.5	3 1/2	DC18-275-08
14	5 1/2	DC18-275-14
16.5	6 1/2	DC18-275-16

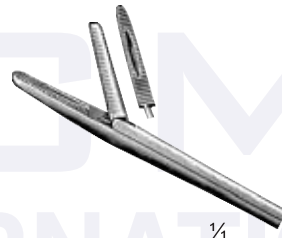

Hartmann-Noyes
DC18-277-09
9 cm/3 1/2"



Hartmann-Noyes
DC18-279-09
9 cm/3 1/2"
1:2 teeth

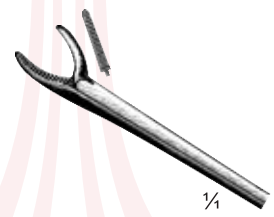

Hartmann-Weingartner
DC18-281-08
8.5 cm/3 1/2"

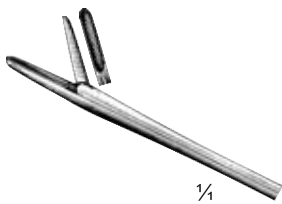

Hartmann
DC18-283-08
8.5 cm/3 1/2"

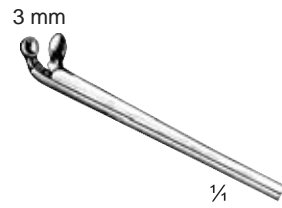

Hartmann
DC18-285-08
8.5 cm/3 1/2"

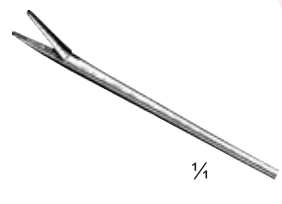

Hartmann-Wullstein
DC18-287-08
8.5 cm/3 1/2"

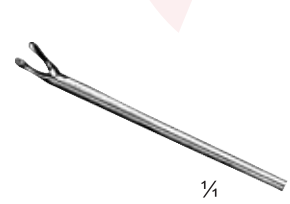

Hartmann-Wullstein
DC18-289-08
8.5 cm/3 1/2"

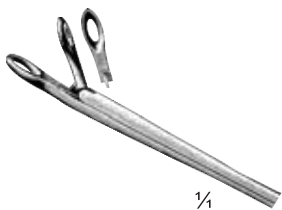

Struempel
DC18-291-08
8.5 cm/3 1/2"

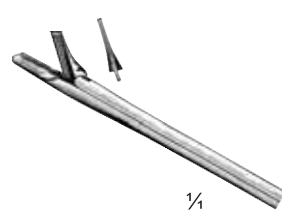

Hartmann
DC18-293-08
8.5 cm/3 1/2"
Punch action through-cutting,
also for foreign bodies

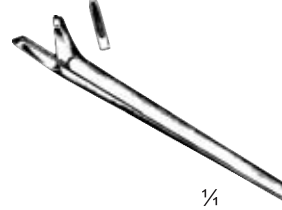

Hartmann
DC18-295-08
8.5 cm/3 1/2"
Punch action through-cutting,
also for foreign bodies

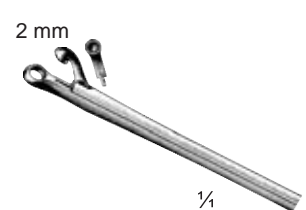

Hartmann-Hoffmann
DC18-297-08
8.5 cm/3 1/2"
Punch action through-cutting,
also for foreign bodies

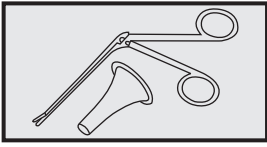

Chisels and Gouges, Ear Punches

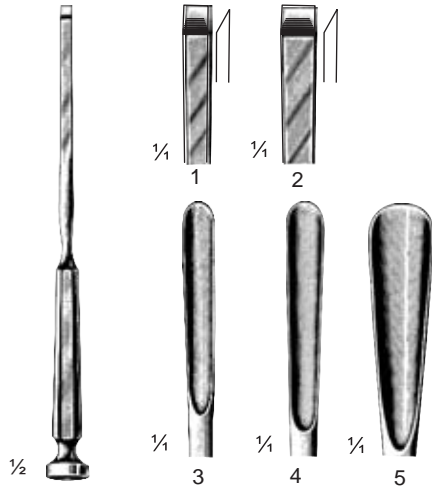

Fischer
12.5 cm /5"
width

Fig.	mm	
1	4	DC18-299-04
2	5	DC18-299-05
3	4	DC18-301-04
4	5	DC18-301-05
5	9	DC18-301-09

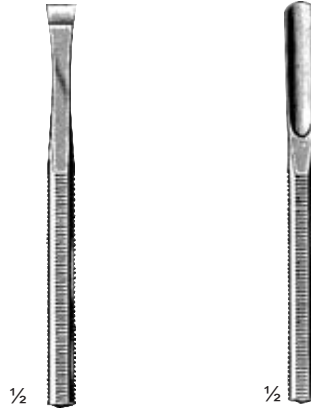

Schwartz
11 cm /4 1/2"

chisels	width	
	mm	gouges
DC18-303-03	3	DC18-305-03
DC18-303-04	4	DC18-305-04
DC18-303-05	5	DC18-305-05
DC18-303-06	6	DC18-305-06
DC18-303-08	8	DC18-305-08

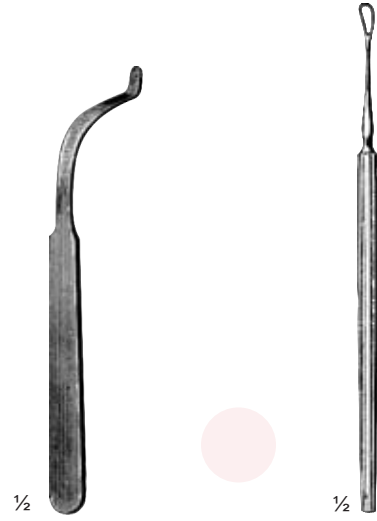

Stacke
DC18-307-12
12 cm /4 3/4"
Protector and Guide

Langenbeck
DC18-309-13
13 cm /5 1/4"



Citelli
DC18-311-17



Beyer
DC18-313-19

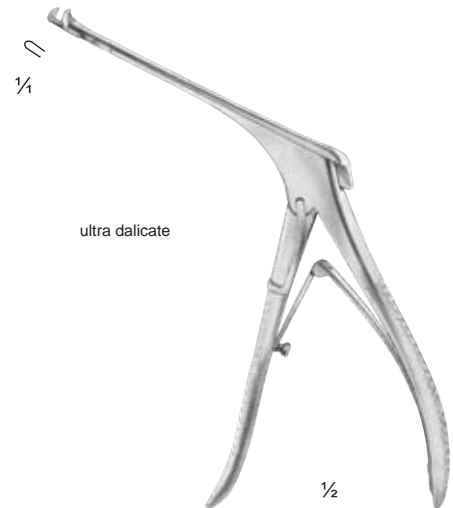

Beyer
DC18-315-14

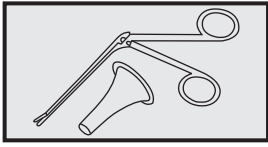

Knives, Perforators

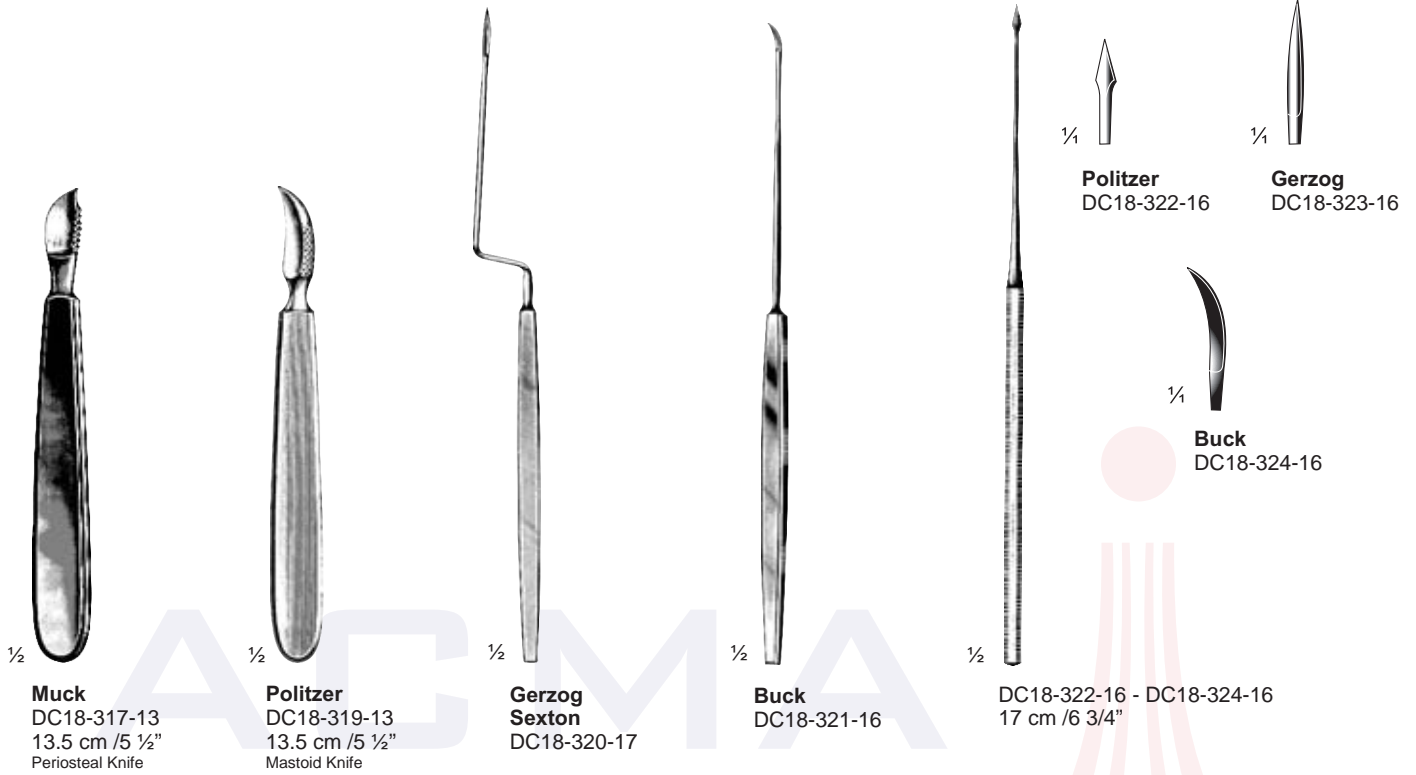

Instruments for Fenestration

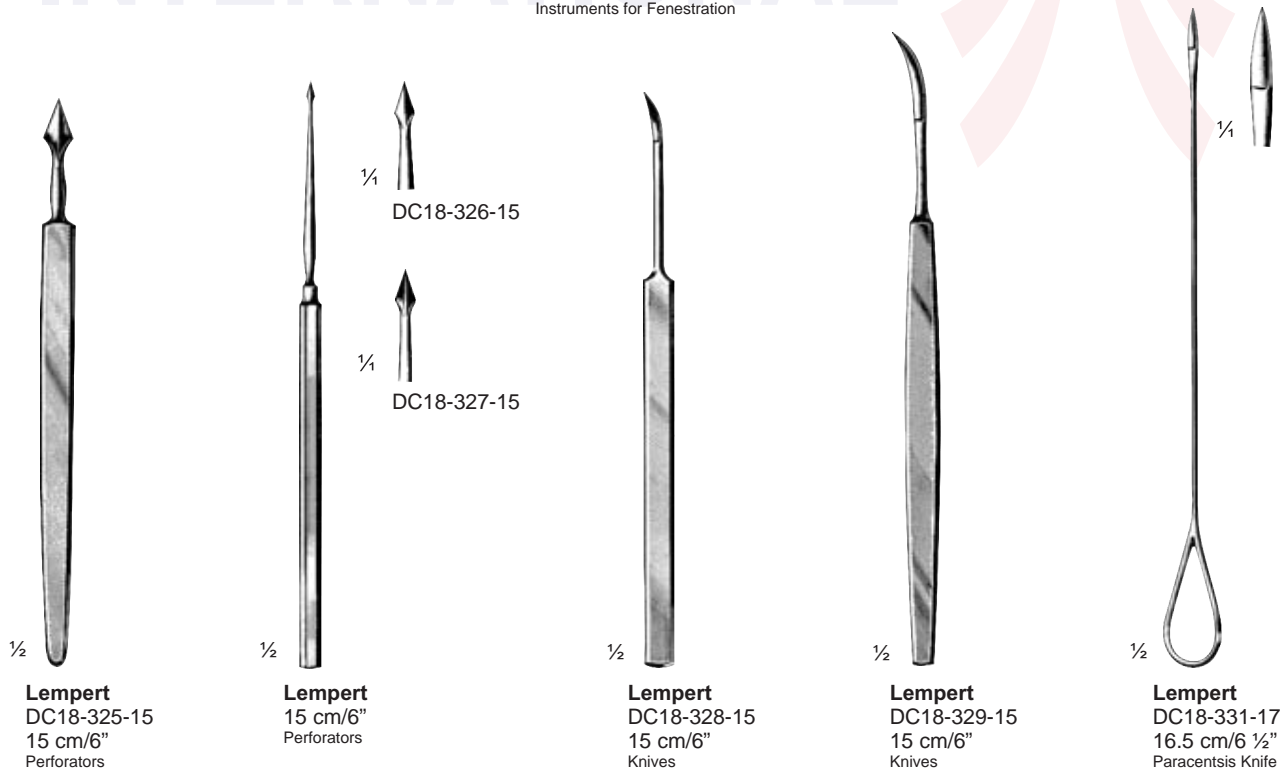

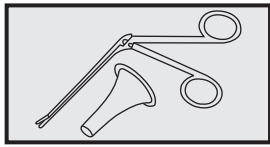

Instruments for Fenestration, Curettes and Spoons

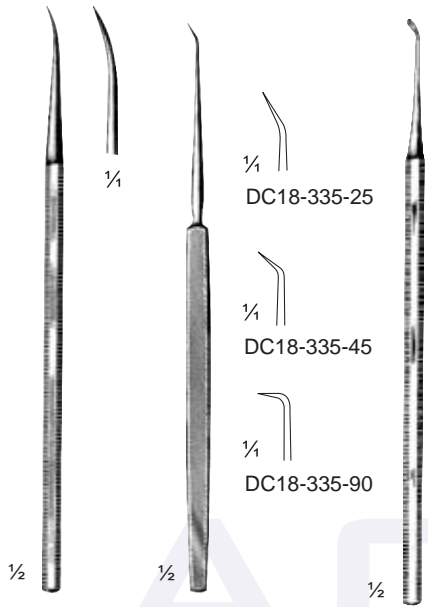

DC18-333-15
15 cm/6"
Fistula Probes

Shambaugh
15 cm/6"
Fistula Probes

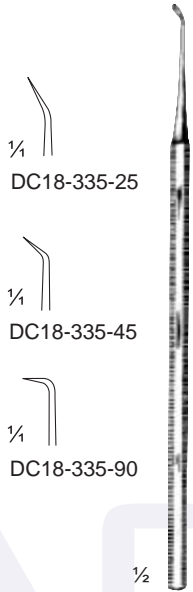

DC18-335-25

DC18-335-45

DC18-335-90

Lempert
16 cm/6 1/2"
Excavators



DC18-337-15
Lempert

DC18-339-15
Lempert

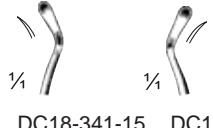

DC18-341-15

DC18-343-15



Lempert
19 cm/7 1/2"
Elevators

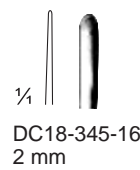

DC18-345-16
2 mm

DC18-347-16
2 mm



DC18-349-16
3 mm



Lempert
DC18-351-17
18 cm/7 1/4"
Elevators



Lempert
DC18-353-20
20.5 cm/5 1/4"
Elevators

DC18-355-10

DC18-355-20

DC18-355-30

DC18-355-40

DC18-355-50



Lempert
DC18-355-10-DC18-355-50
17.5 cm/7"
Sharp spoon



Bishop
sharp

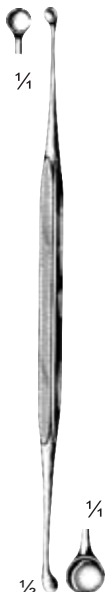

Jansen
DC18-359-15
sharp



House
DC18-361-15
15 cm /6"



Antoli-Candela
DC18-363-15
15 cm /6"



Barth
DC18-365-18
18 cm /7 1/4"
sharp

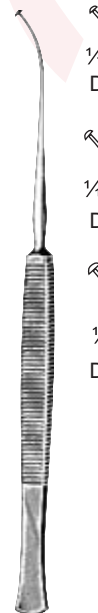

Yankauer
16 cm 6 1/2"

DC18-367-01

DC18-367-02

DC18-367-03

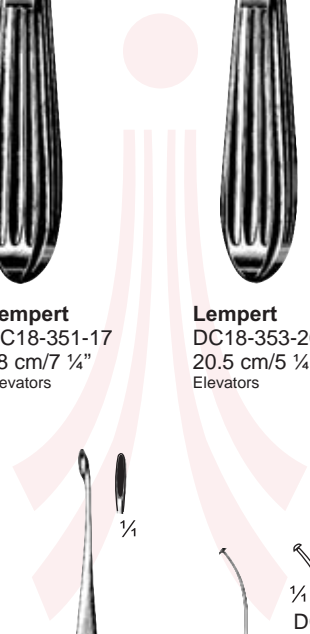

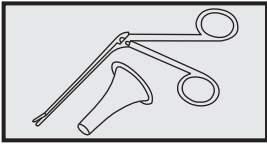

Roser
DC18-369-14
14 cm / 5 1/2"
blunt



Gross
DC18-371-12
12 cm / 4 3/4"
blunt / sharp



Gross
DC18-373-12
12 cm / 4 3/4"
blunt



Gross
DC18-375-12
12 cm / 4 3/4"
blunt



Gross
DC18-377-12
12 cm / 4 3/4"
blunt / sharp



Gross
DC18-379-12
12 cm / 4 3/4"

ACMA
INTERNATIONAL



DC18-381-01
16 cm / 5 1/2"

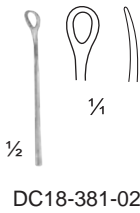

DC18-381-02



Billeau
16.5 cm / 6 1/2"
Loops

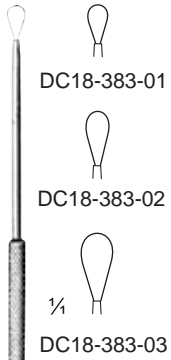

DC18-383-01

DC18-383-02

DC18-383-03



Moldenhauer
DC18-385-16
16.5 cm / 6 1/2"
Foreign Body Levers



Zaufal
DC18-387-16
16 cm / 6 1/2"
Foreign Body Levers

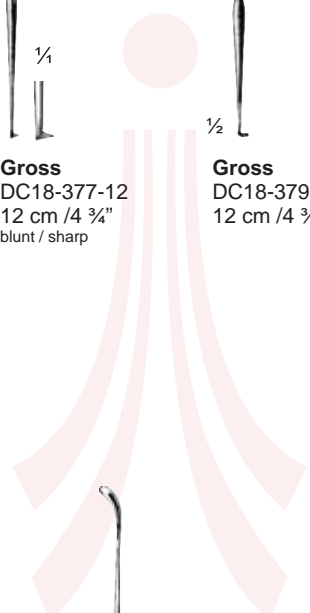

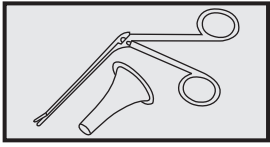

Circular Knives (Periosteals), Mobilization Chisels



DC18-391-01 16.5 cm/6½" DC18-391-02 16.5 cm/6½" DC18-391-03 16.5 cm/6½" DC18-391-04 16.5 cm/6½" DC18-391-05 16.5 cm/6½" DC18-391-06 16.5 cm/6½" DC18-391-07 16.5 cm/6½" DC18-391-08 16.5 cm/6½" DC18-391-09 16.5 cm/6½"

ALMA INTERNATIONAL

DC18-389-01 16 cm/6½"

Mobilization Chisels

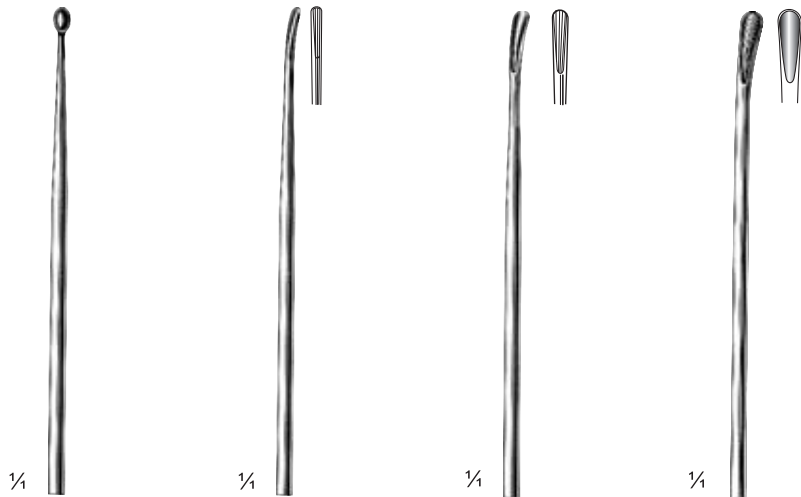

DC18-393-01 6.5 cm/2 ¾"

DC18-395-01 6.5 cm/2 ¾"

DC18-395-02 6.5 cm/2 ¾"

DC18-395-03 6.5 cm/2 ¾"

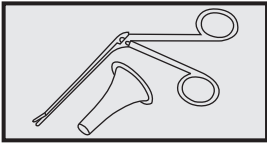

Hooklet

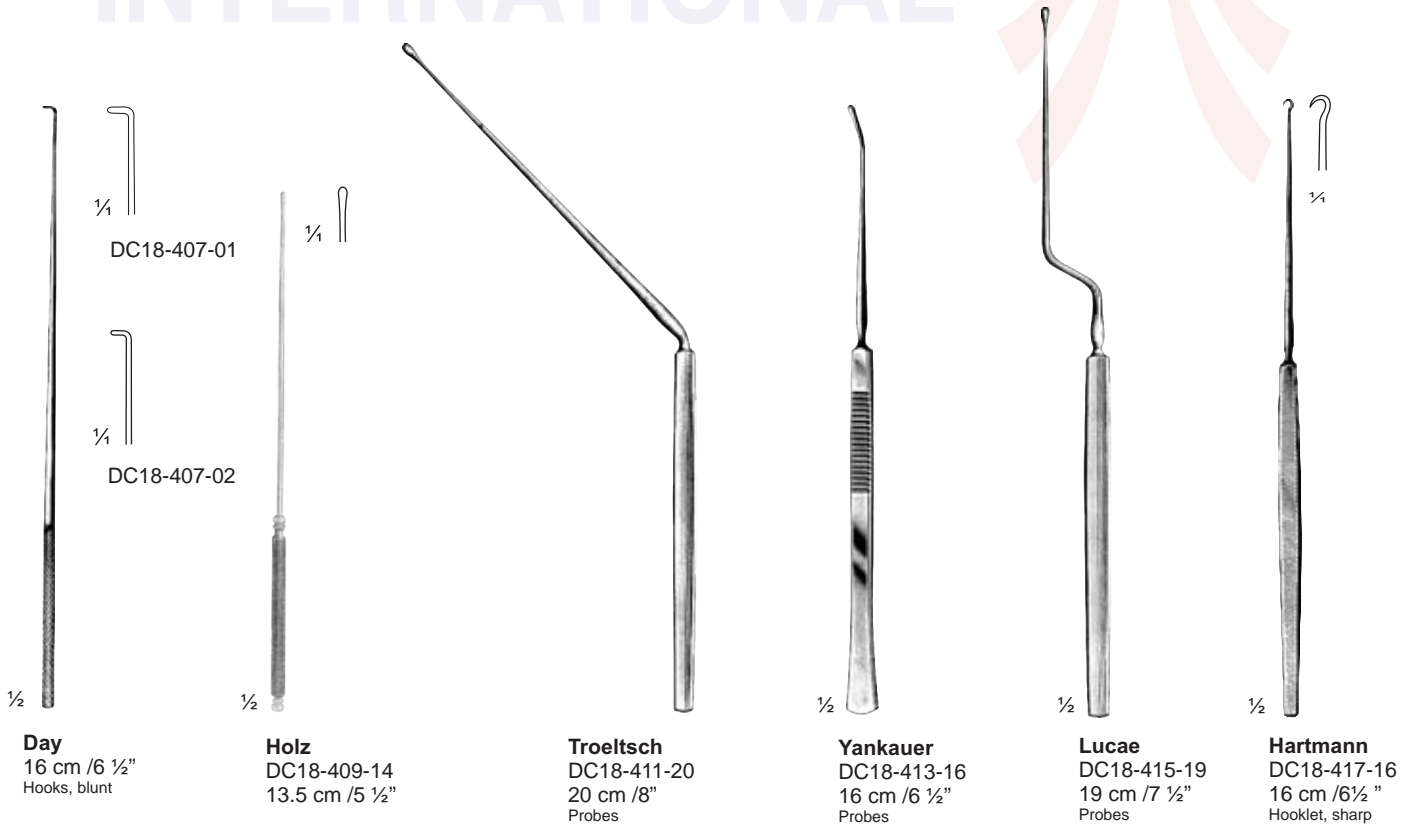
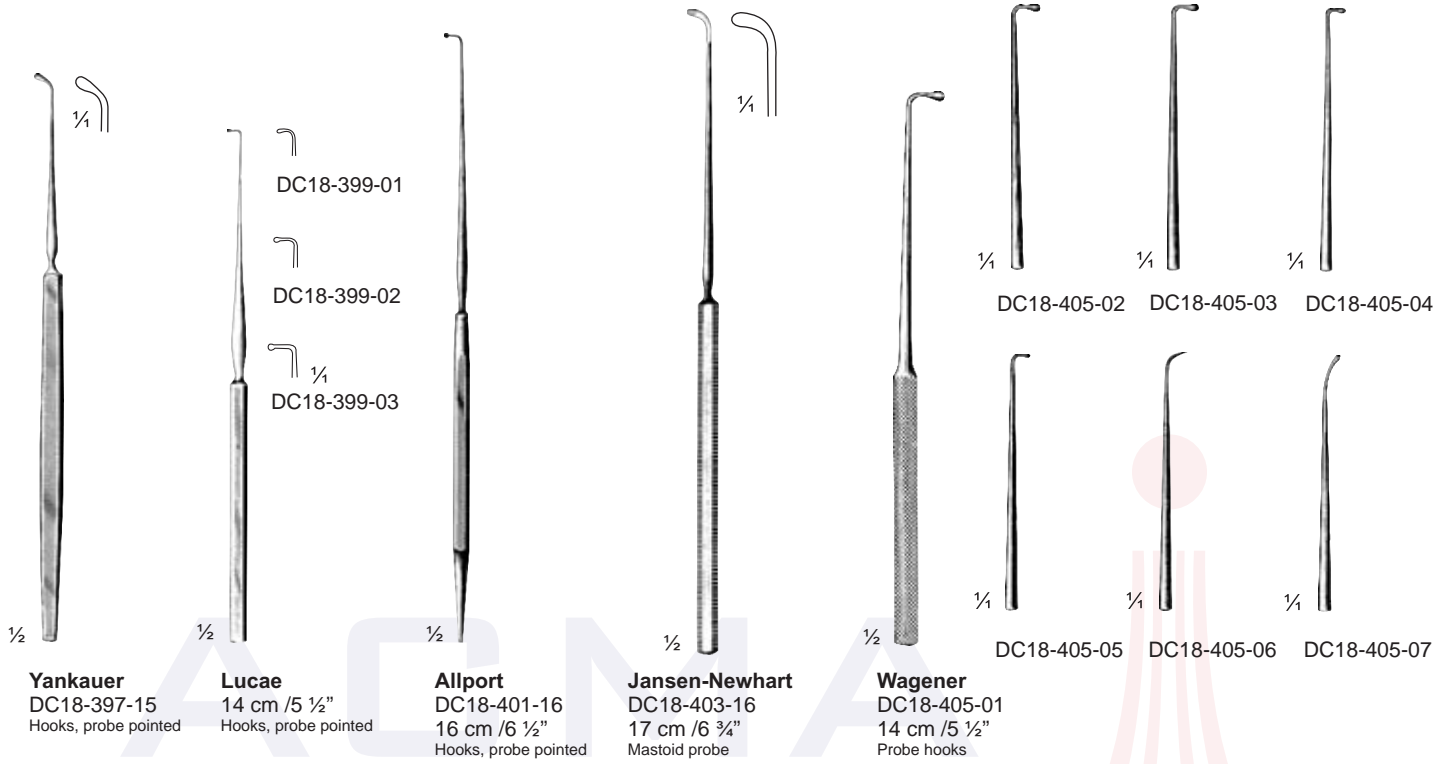

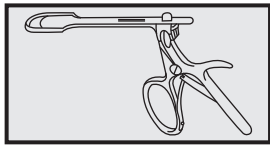

Tonsil Knives, Dissectors, Enucleator, Retractor etc.



Harris
DC18-451-26
26 cm/10 $\frac{1}{4}$ "
Tonsil Knife and Dissectoe

Carpenter
DC18-453-25
25 cm/10"
Tonsil Knife and Enucleartor

Carpenter
DC18-455-24
24 cm/9 $\frac{1}{2}$ "
Tonsil Knives
and Dissectors

Milette
DC18-457-26
26 cm/10 $\frac{1}{4}$ "
Tonsil Knives
and Dissectors

Hurd
DC18-459-22
22.5 cm/9"
Tonsil Dissector
and Retractor

Yankauer
DC18-461-21
21 cm/8 $\frac{1}{4}$ "
Tonsil Elevator

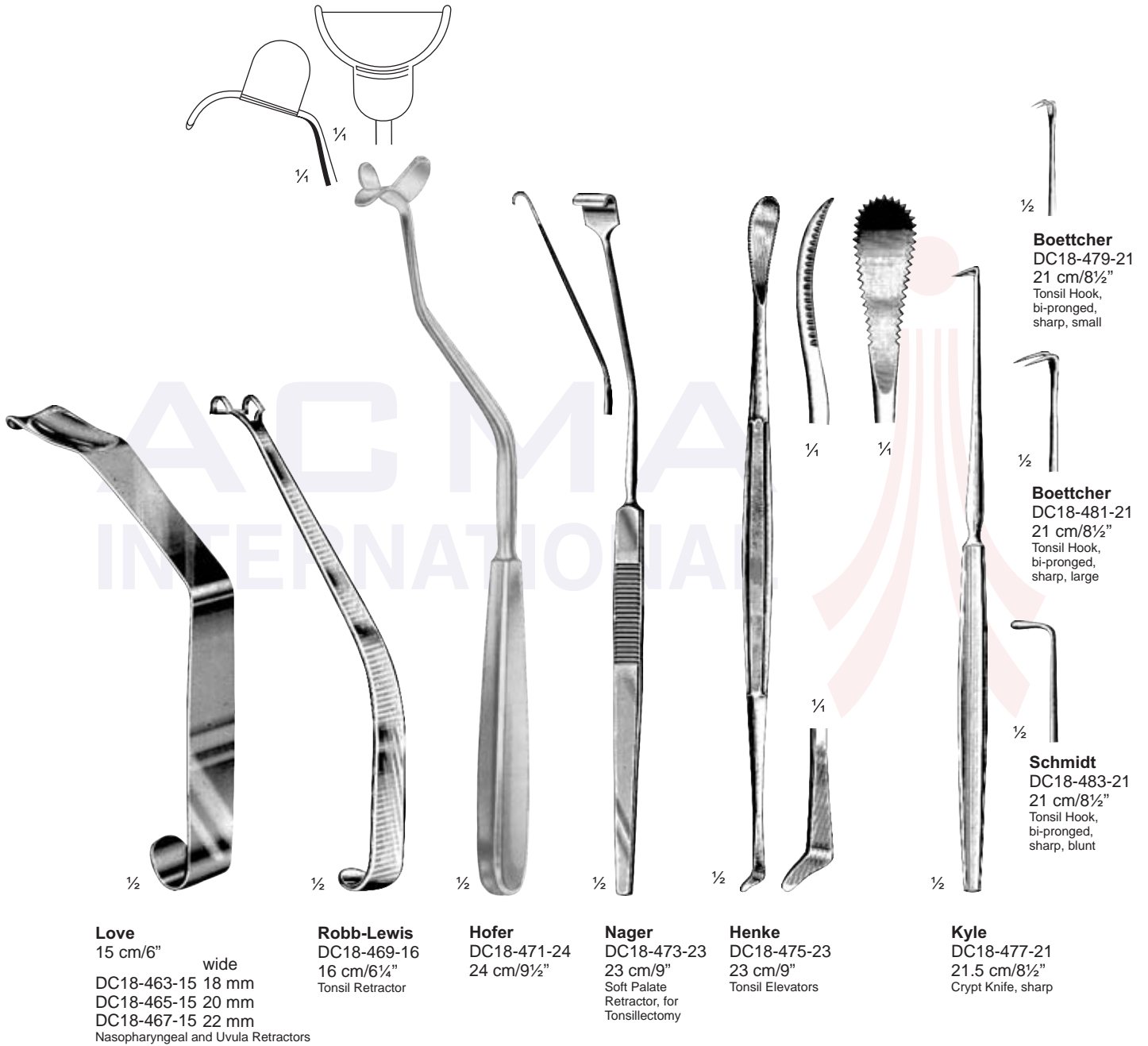
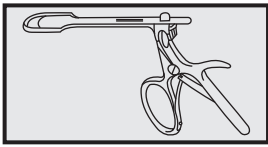

Love
15 cm/6" wide
DC18-463-15 18 mm
DC18-465-15 20 mm
DC18-467-15 22 mm
Nasopharyngeal and Uvula Retractors

Robb-Lewis
DC18-469-16
16 cm/6¼"
Tonsil Retractor

Hofer
DC18-471-24
24 cm/9½"

Nager
DC18-473-23
23 cm/9"
Soft Palate
Retractor, for
Tonsillectomy

Henke
DC18-475-23
23 cm/9"
Tonsil Elevators

Kyle
DC18-477-21
21.5 cm/8½"
Crypt Knife, sharp

Boettcher
DC18-479-21
21 cm/8½"
Tonsil Hook,
bi-pronged,
sharp, small

Boettcher
DC18-481-21
21 cm/8½"
Tonsil Hook,
bi-pronged,
sharp, large

Schmidt
DC18-483-21
21 cm/8½"
Tonsil Hook,
bi-pronged,
sharp, blunt

Tonsil Seizing Forceps

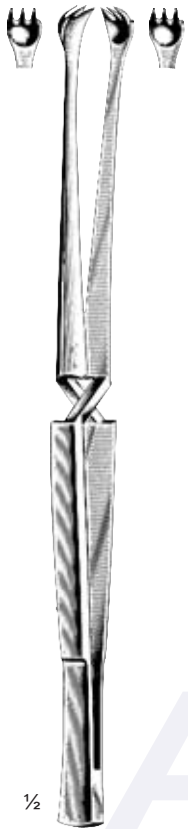
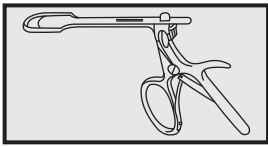

Marschik
DC18-485-22
22 cm/8 3/4"



1/4
DC18-491-19
straight



1/4
DC18-493-19
curved

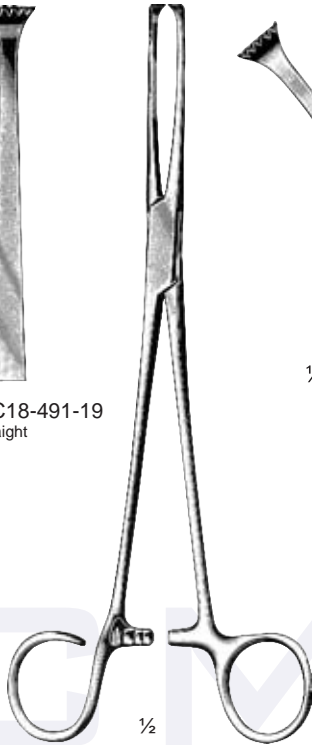

Colver
19 cm/7 1/2"



1/4
DC18-495-21
1 open ring
with screw



1/4
DC18-497-21
1 open ring
with screw

Tivnen-Tyding
DC18-495-21 - DC18-497-21
21 cm/8 1/4"



Ballenger
DC18-499-21
21.5 cm/8 1/2"



White
DC18-501-18 = 18 cm/7"
DC18-503-23 = 23 cm/9"

Tonsil Seizing and Haemostatic Forceps, Tonsil Snare

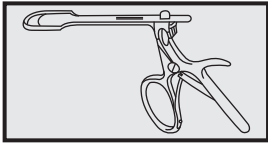

Blohmke
DC18-505-20
20 cm / 8"
Tonsil Seizing
Forceps

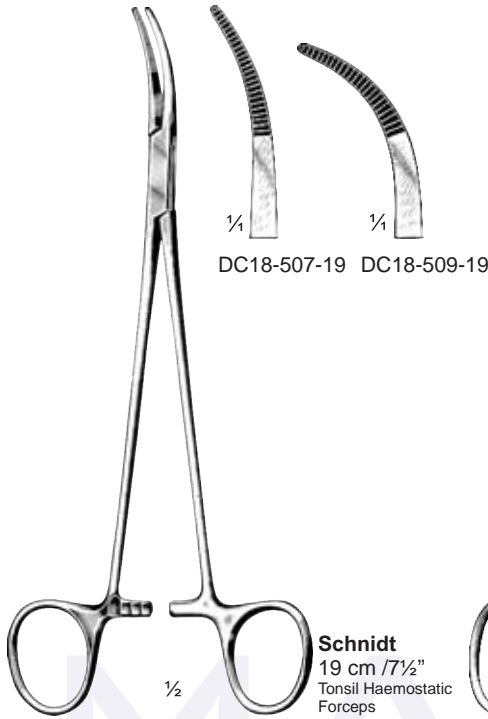

Schmidt
19 cm / 7½"
Tonsil Haemostatic
Forceps

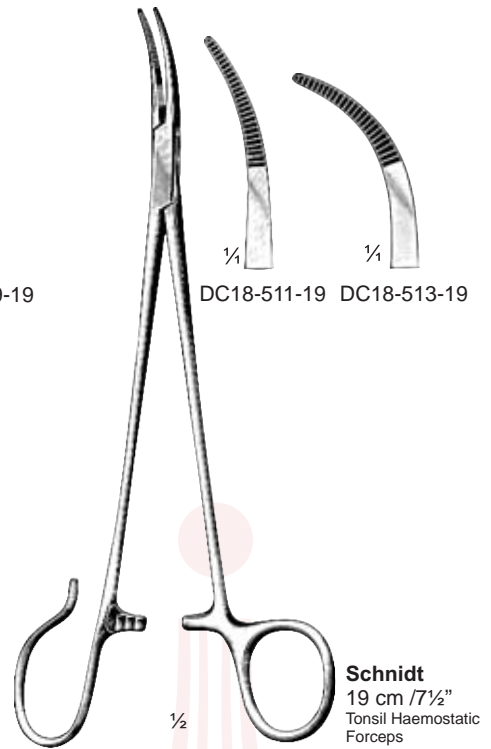

Schmidt
19 cm / 7½"
Tonsil Haemostatic
Forceps

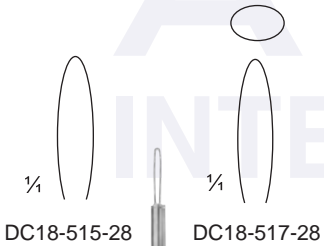

DC18-515-28

DC18-517-28



Eves
28 cm / 11"
Tonsil Snare



Eves
DC18-519-28
28 cm / 11"
Tonsil Snare



Bruenings
DC18-521-28
28 cm / 11"
Tonsil Snare



DC18-523-01
0.3 mm ø
Snare Wires, cut and ready for use,
in envelops of 1 dozen

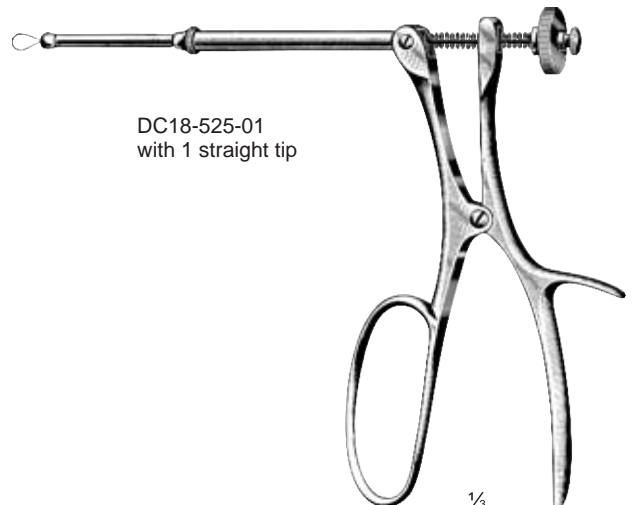

Brown
Tonsil Snare

DC18-525-01
with 1 straight tip

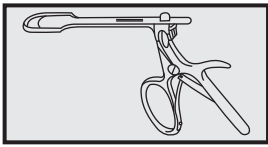

Laryngeal Mirrors, Laryngeal Polypus Forceps



DC18-527-08
DC18-527-10
DC18-527-12
DC18-527-14
DC18-527-16
DC18-527-18
DC18-527-20
DC18-527-22
DC18-527-24
DC18-527-26
DC18-527-28
DC18-527-30

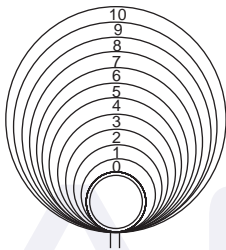

Fig. 00 = 8 mm ø
Fig. 0 = 10 mm ø
Fig. 1 = 12 mm ø
Fig. 2 = 14 mm ø
Fig. 3 = 16 mm ø
Fig. 4 = 18 mm ø
Fig. 5 = 20 mm ø
Fig. 6 = 22 mm ø
Fig. 7 = 24 mm ø
Fig. 8 = 26 mm ø
Fig. 9 = 28 mm ø
Fig. 10 = 30 mm ø



DC18-529-08
DC18-529-10
DC18-529-12
DC18-529-14
DC18-529-16
DC18-529-18
DC18-529-20
DC18-529-22
DC18-529-24
DC18-529-26
DC18-529-28
DC18-529-30



Michel
DC18-531-10 - DC18-531-18
25 cm / 10"



1/4
DC18-531-10



1/4
DC18-531-12



1/4
DC18-531-14



1/4
DC18-531-16



1/4
DC18-531-18

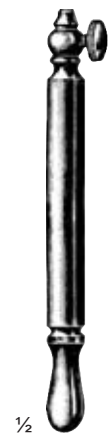

1/2
DC18-533-11

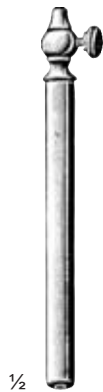

1/2
DC18-535-10

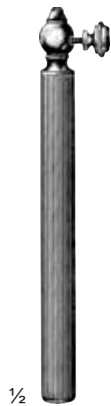

1/2
DC18-537-11



1/2
DC18-539-12

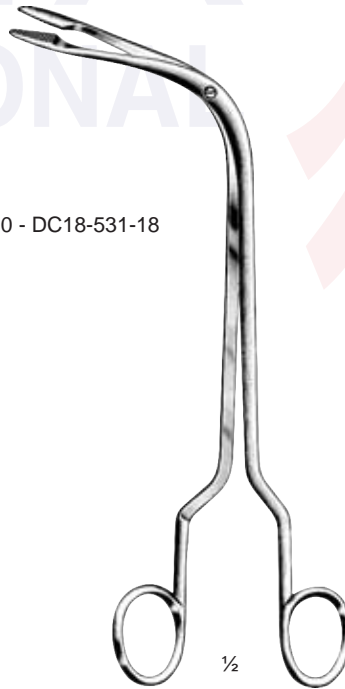

Fraenkel
DC18-541-18
18 cm / 7"



Fraenkel
DC18-543-19
19 cm / 7 1/2"

DC18-527-08 - DC18-527-30 - Laryngeal Mirrors with fixed handle
DC18-529-08 - DC18-529-30 - ditto, without handle
DC18-531-10 - DC18-531-18 - Metal Handle for laryngeal mirrors DC18-529-08 - DC18-529-30
DC18-541-18 - DC18-543-19 - Laryngeal Polypus Forceps

Laryngeal Polypus Forceps, Epiglottis Retractor, Tampon Forceps

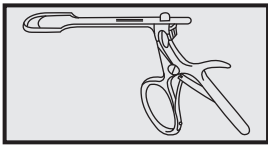

Jurasz
23 cm/9"
Laryngeal Polypus Forceps

Jackson
22 cm/8 3/4"
DC18-547-22
Applicator (Tampon)
Forceps, cross-action

Reichert
DC18-549-24
24 cm/9 1/2"
Epiglottis Retractor

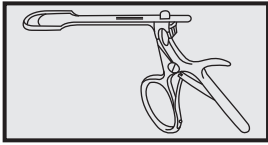

Chevalier- Jackson

N
Fig. mm ø 45-90 mm

0	4	DC18-551-04
1	5	DC18-551-05
2	6	DC18-551-06
3	7	DC18-551-07
4	8	DC18-551-08
5	9	DC18-551-09
6	10	DC18-551-10
7	11	DC18-551-11
8	12	DC18-551-12
9	13	DC18-551-13

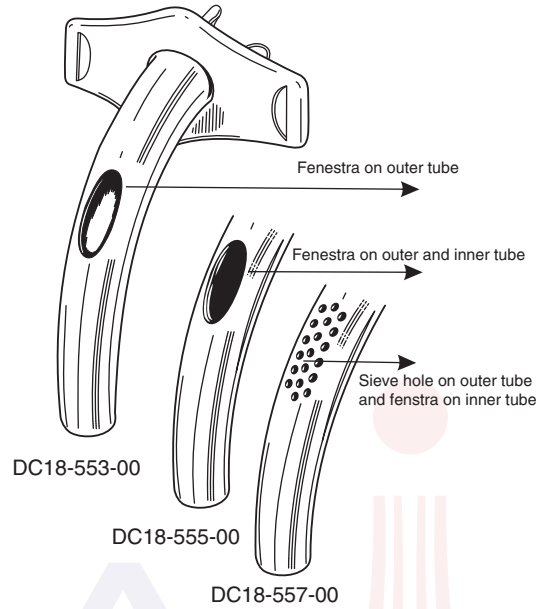

ACMA INTERNATIONAL

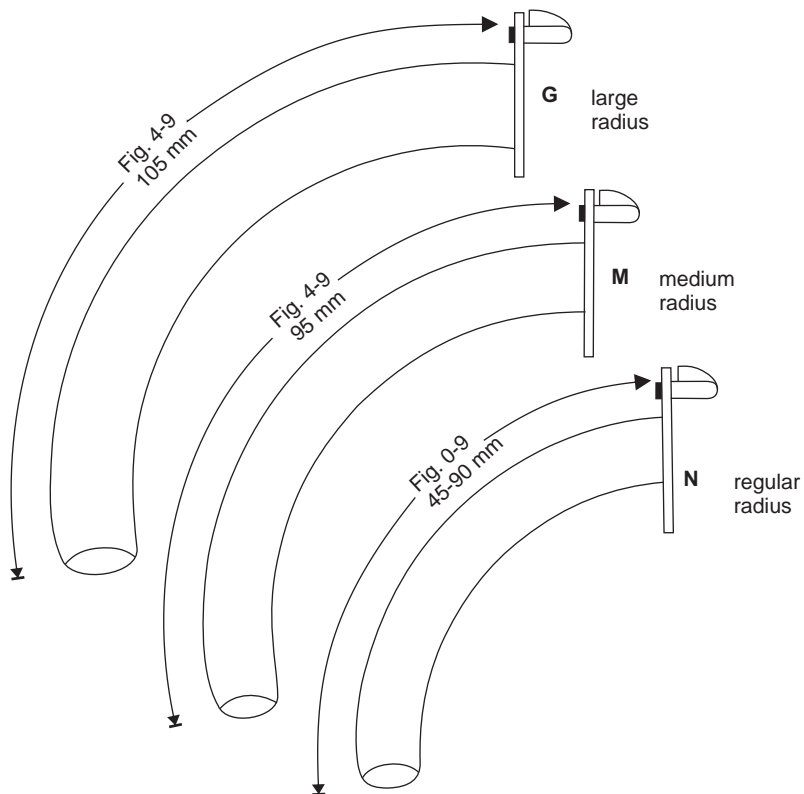

standard pattern

Luer	N	M	G	
Fig.	mm ø	45-90 mm	95 mm	105 mm
0	4	DC18-559-04		
1	5	DC18-559-05		
2	6	DC18-559-06		
3	7	DC18-559-07		
4	8	DC18-559-08	DC18-561-08	DC18-563-08
5	9	DC18-559-09	DC18-561-09	DC18-563-09
6	10	DC18-559-10	DC18-561-10	DC18-563-10
7	11	DC18-559-11	DC18-561-11	DC18-563-11
8	12	DC18-559-12	DC18-561-12	DC18-563-12
9	13	DC18-559-13	DC18-561-13	DC18-563-13

Trachea Retractors

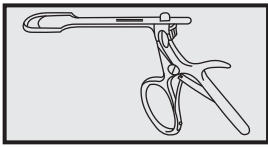

left



right

sharp

Bose
DC18-565-16
16 cm / 6 1/4"

Bose
DC18-567-16
16 cm / 6 1/4"

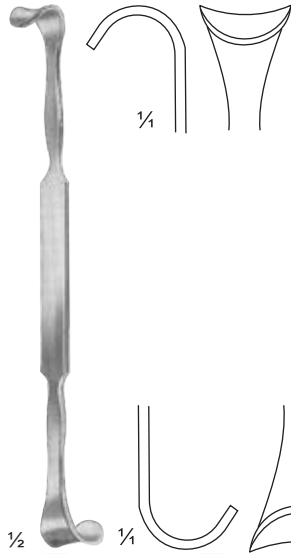

Rose
DC18-569-13
13 cm / 5"

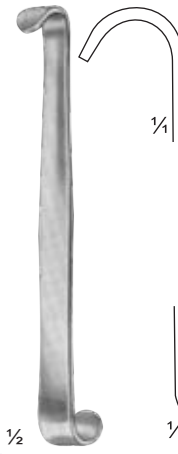

Luer
DC18-571-11
11 cm / 4 1/2"
Trachea Retractors



Jackson
DC18-573-15
15 cm / 6"
Trachea Tenaculum

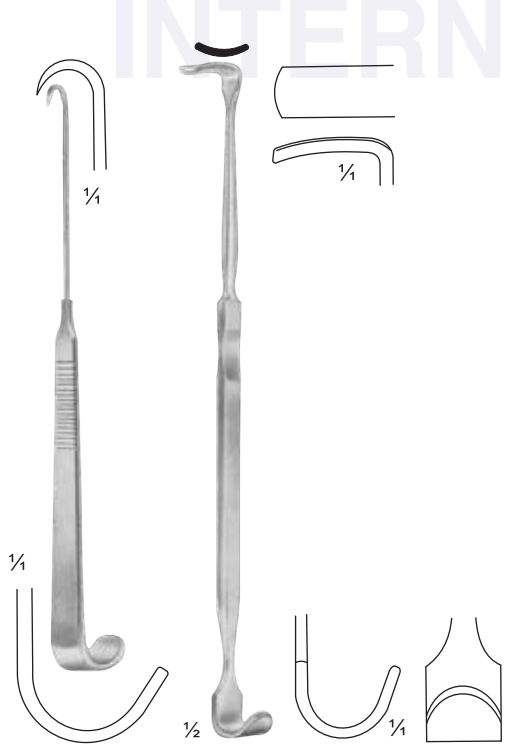

DC18-575-15
15 cm / 6"

Lukens
DC18-577-17
17 cm / 6 3/4"
Thymus Retractor,
double-ended

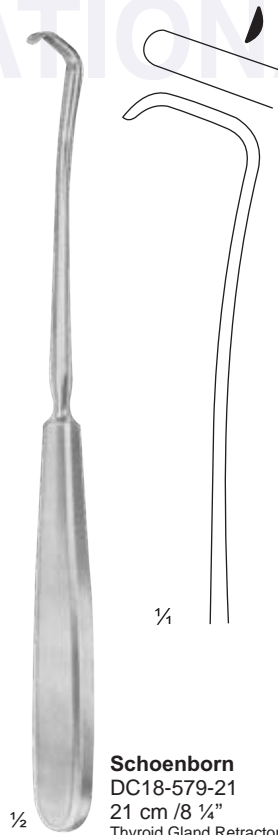

Schoenborn
DC18-579-21
21 cm / 8 1/4"
Thyroid Gland Retractor



Bose
DC18-581-07
7 cm / 2 3/4"



Iterson
Trachea Retractors

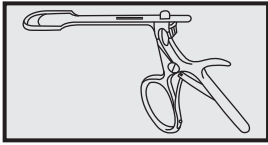

Trachea Trocars, Dilators, Punches, and Retractors

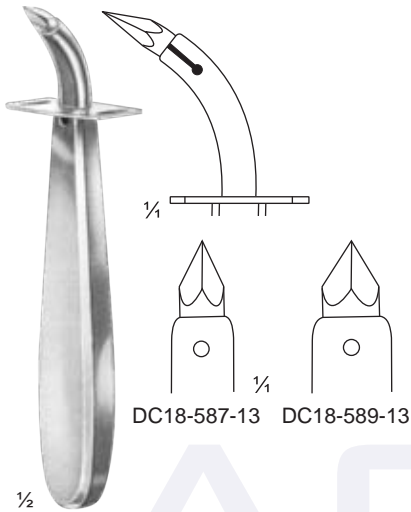

DC18-587-13 DC18-589-13

Uckermann

DC18-587-13 = 8 mm ø
DC18-589-13 = 10 mm ø
13 cm / 5"

Trachea Trocars for Inter- cricothyrotomy,
with stainless steel point, cannula of silver 835



Weerda

DC18-591-19
19 cm / 7 1/2"
Tracheotomy Spreader

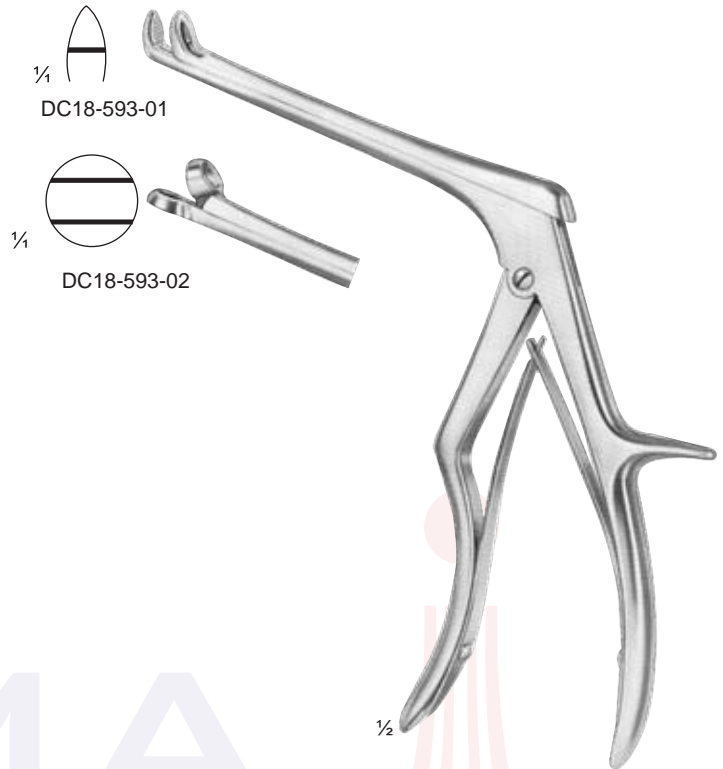

DC18-593-01

DC18-593-02

DC18-593-01 - DC18-593-02
Tracheotomy Punches

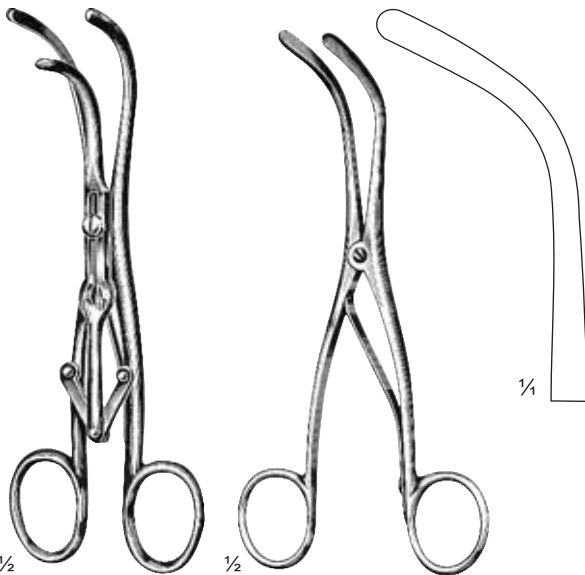

Laborde

DC18-595-14
14 cm / 5 1/2"
Trachea Dilators

Trousseau

DC18-597-14
14 cm / 5 1/2"
Trachea Dilators



Jakson

DC18-599-17
17 cm / 6 3/4"
Trachea Retractors, double-ended



Jakson

DC18-601-18
18 cm / 7"
blunt
Trachea Retractors, double-ended

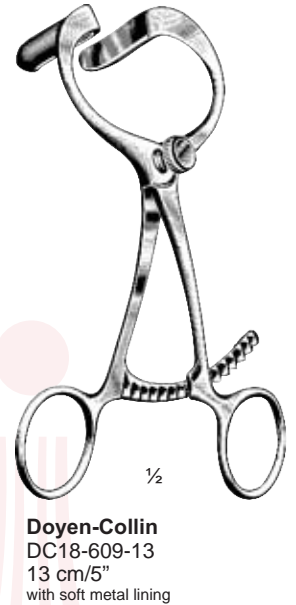
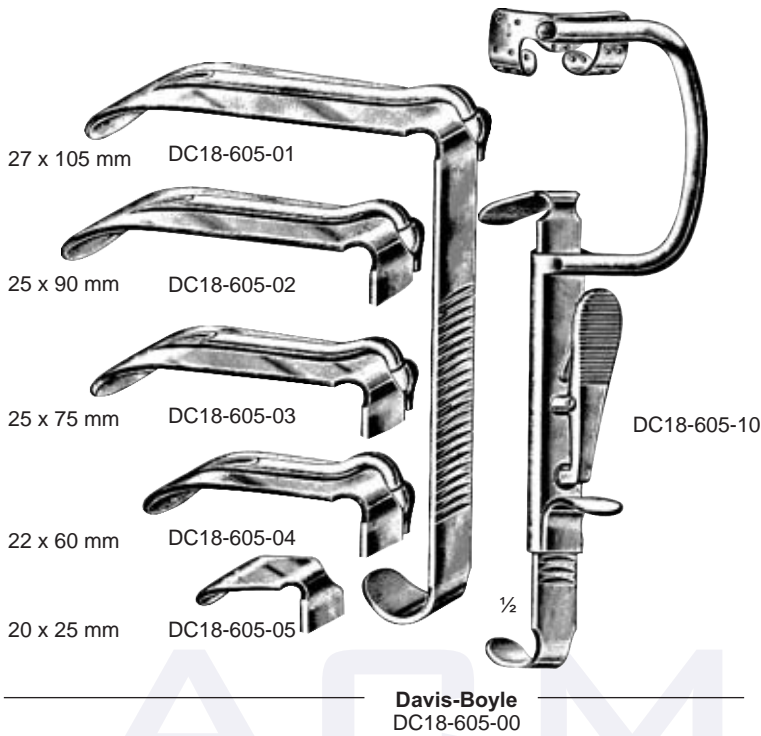
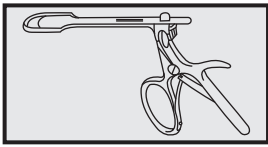

ACMA
INTERNATIONAL

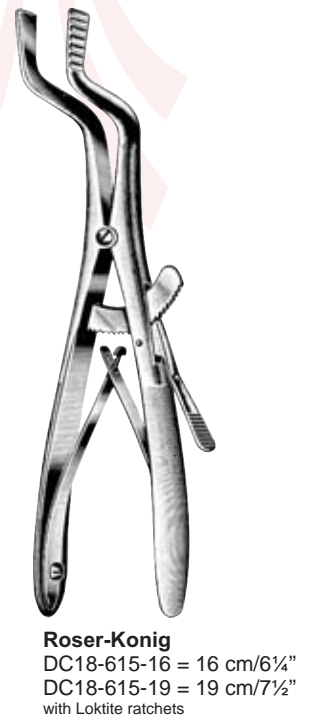
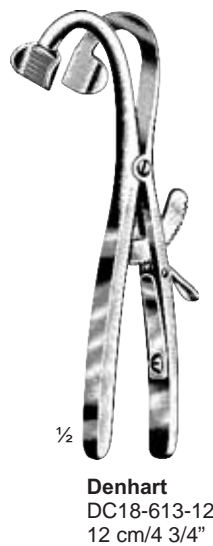

- DC18-605-00 - complete with frame (handle) and 5 interchangeable tongue depressors.
DC18-605-01 - 04 with 1 anaesthetic tube each
- DC18-605-01 - DC18-605-05 - Tongue Depressors only
- DC18-605-10 - Frame (Handle) only

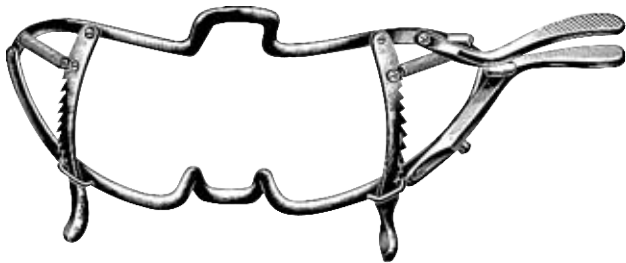
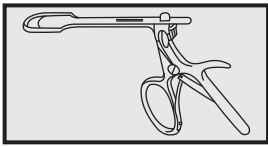

Whitehead

DC18-617-11 = 11 cm/4¼"
 DC18-617-13 = 13 cm/5"
 DC18-617-15 = 15 cm/6"
 with one lateral handle,
 without tongue depressor



Jennings

DC18-619-09 = 9 cm/3½"
 DC18-619-11 = 11 cm/4½"
 DC18-619-13 = 13 cm/5"
 DC18-619-15 = 15 cm/6"
 with one lateral handle,
 without tongue depressor, with Loktite ratchet

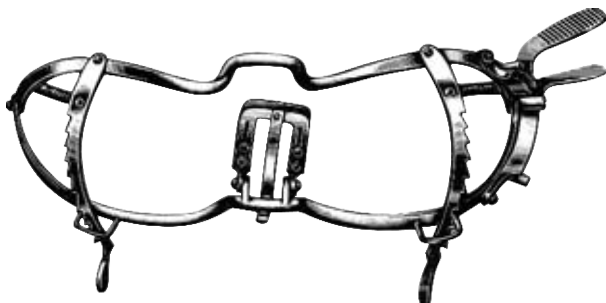

Whitehead

DC18-623-13
 13 cm/5"
 with one lateral handle,
 with tongue depressor

27 x 95 mm DC18-621-01

22 x 85 mm DC18-621-02

22 x 70 mm DC18-621-03

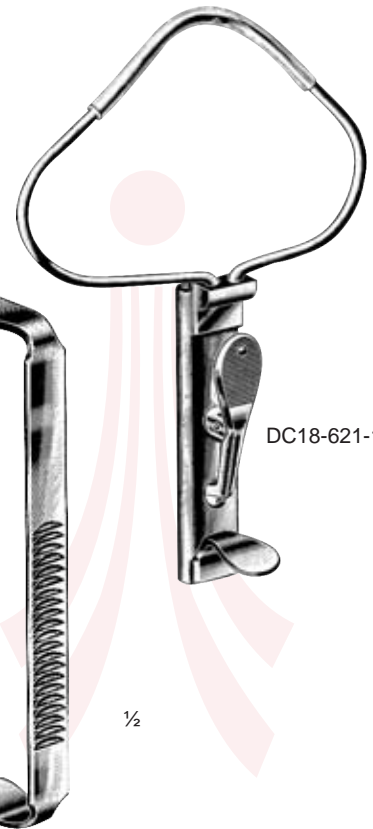

DC18-621-10

½

McIvor

DC18-621-00

DC18-621-00

complete with frame (handle) and 3 interchangeable tongue depressors, without anaesthetic tube

DC18-621-01 - DC18-621-03

Tongue Depressors only

DC18-621-10

Frame (Handle) only

Mouth Gags, Cheek and Lip Retractors

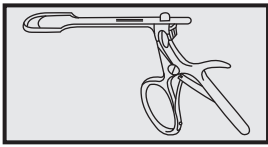

1/2

Kilner-Doughty
DC18-625-00
DC18-625-10



1/2
DC18-625-01
Fig. 1



1/2
DC18-625-02
Fig. 2



1/2
DC18-625-03
Fig. 3

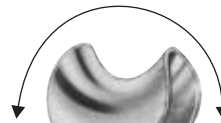

1/2

Martin-Simplex
DC18-627-11
11 cm/4 1/2"



Sternberg



Sternberg

	cm	in.	
DC18-629-12	12	4 3/4	DC18-631-12
DC18-629-14	14	5 1/2	DC18-631-14
DC18-629-16	16	6 1/4	DC18-631-16
DC18-629-16	18	7	



1/2

Mod. Martin
DC18-633-19
19 cm/7 1/2"

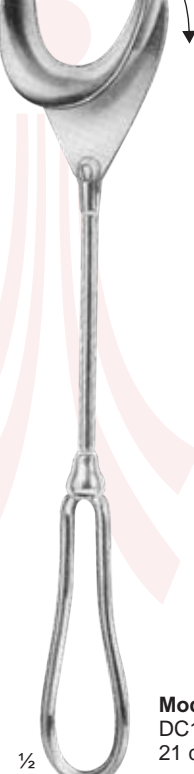

1/2

Mod. Martin
DC18-635-21
21 cm/8 1/4"

DC18-625-00

DC18-625-01
DC18-625-02
DC18-625-03

DC18-625-10

DC18-627-11

DC18-629-14 - DC18-631-16

DC18-633-19 - DC18-635-21

DC18-637-13

- Complete with Frame, 3 Tongue Depressors and 2 Adjustable Tooth Plates, exchangeable, and 1 Palatal Support for toothless
- Tongue Depressor Fig. 1, only
- ditto, Fig. 2 only
- ditto, Fig. 3 only
- Gag only
- Cheek Retractor
- Lip Retractors
- Cheek Retractors, with swivel blade
- Combined Cheek and Lip Retractor



1/2

Bishop
DC18-637-13
13 cm/5"

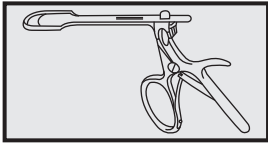

Tongue Depressor and Cotton Roll Holder



Moritz-Schmidt
DC18-639-19
19 cm/7½"
hollow
Tongue Depressors



Hartmann
DC18-641-15
15 cm/6"
Tongue Depressors



Tobold
DC18-643-14
14.5 cm/5½"
solid
Tongue Depressors



Tobold
DC18-647-14
14.5 cm/5½"
hollow
Tongue Depressors

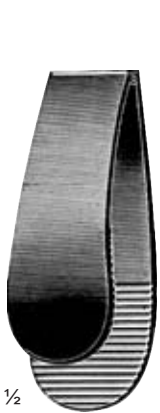

Tobold
DC18-649-02
12 cm/4¾"
folding type
Tongue Depressors



Andrew
DC18-651-11
11 cm/4½"

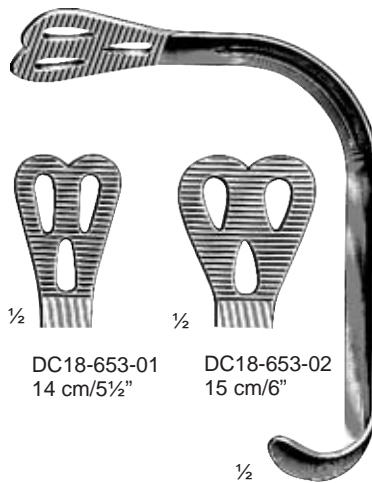

Wieder



DC18-653-01
14 cm/5½"



DC18-653-02
15 cm/6"

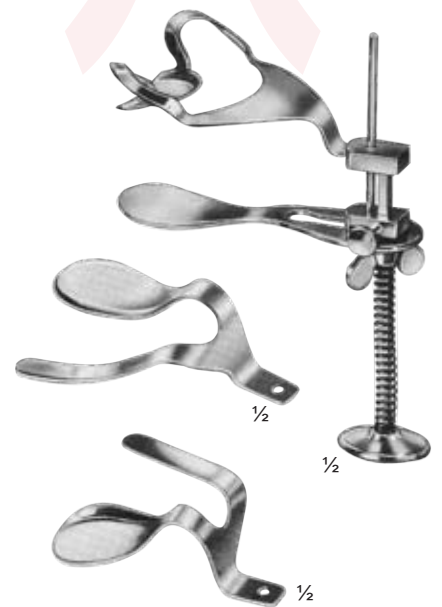

Martin-Zuwafix
DC18-655-00
Tongue Depressor and Cotton
Roll Holder, with Chin Holder

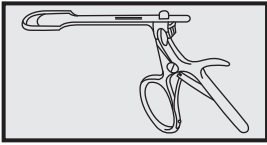

Tongue Depressors, Suction Tubes

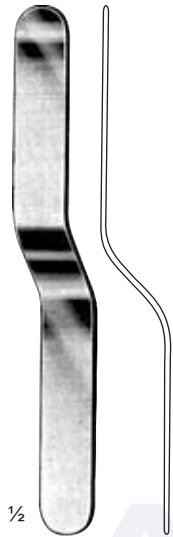

DC18-657-14
14.5 cm/5 3/4"

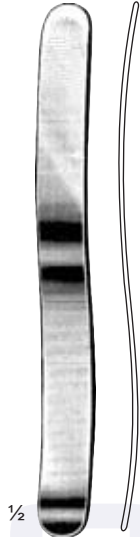

DC18-659-14
14.5 cm/5 3/4"



Doyen
DC18-661-13 = 13 cm/5"
DC18-661-16 = 16 cm/6 1/4"



Kroenig
DC18-663-15
15 cm/6"

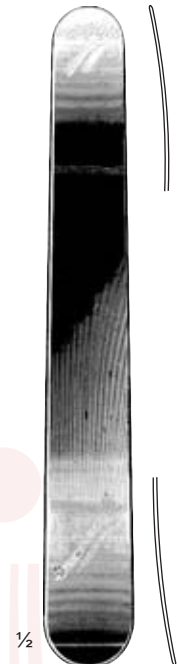

Mayo
DC18-665-17
17 cm/6 3/4"

ACMA INTERNATIONAL

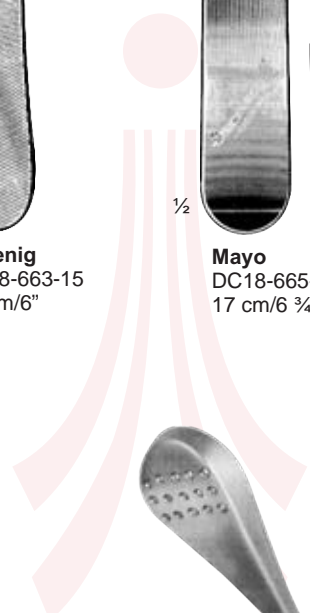

Bruenings
DC18-667-19
19 cm/7 1/2"



Collin
DC18-669-16
16.5 cm/6 1/2"



Mod. Martin
DC18-671-16
16.5 cm/6 1/2"



Frenzel
DC18-673-16
16.5 cm/6 1/2"



Tapia
DC18-675-19
19 cm/7 1/2"

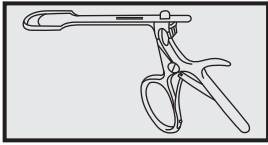

Tongue Holding Forceps

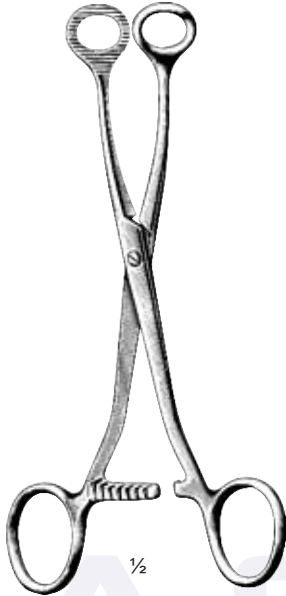

Collin
DC18-677-16
16 cm/6 1/4"

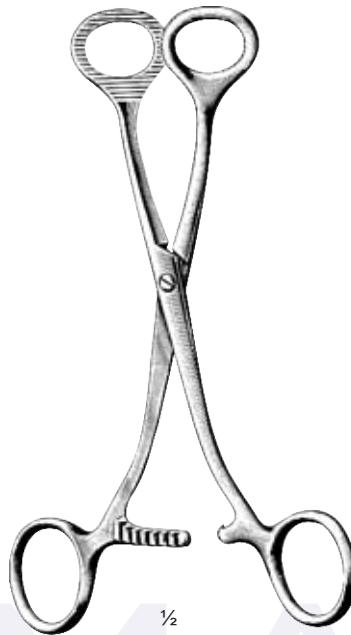

Collin
DC18-679-17 = 17 cm/6 3/4"
DC18-679-19 = 19 cm/7 1/2"



Guy
DC18-681-19
19 cm/7 1/2"



Mathieu
DC18-683-19
19 cm/7 1/2"



Young
DC18-685-17
17 cm/6 3/4"
with interchangeable toothed rubber jaws

DC18-687-02
pair
Rubber Jaws only