

8

Retractors

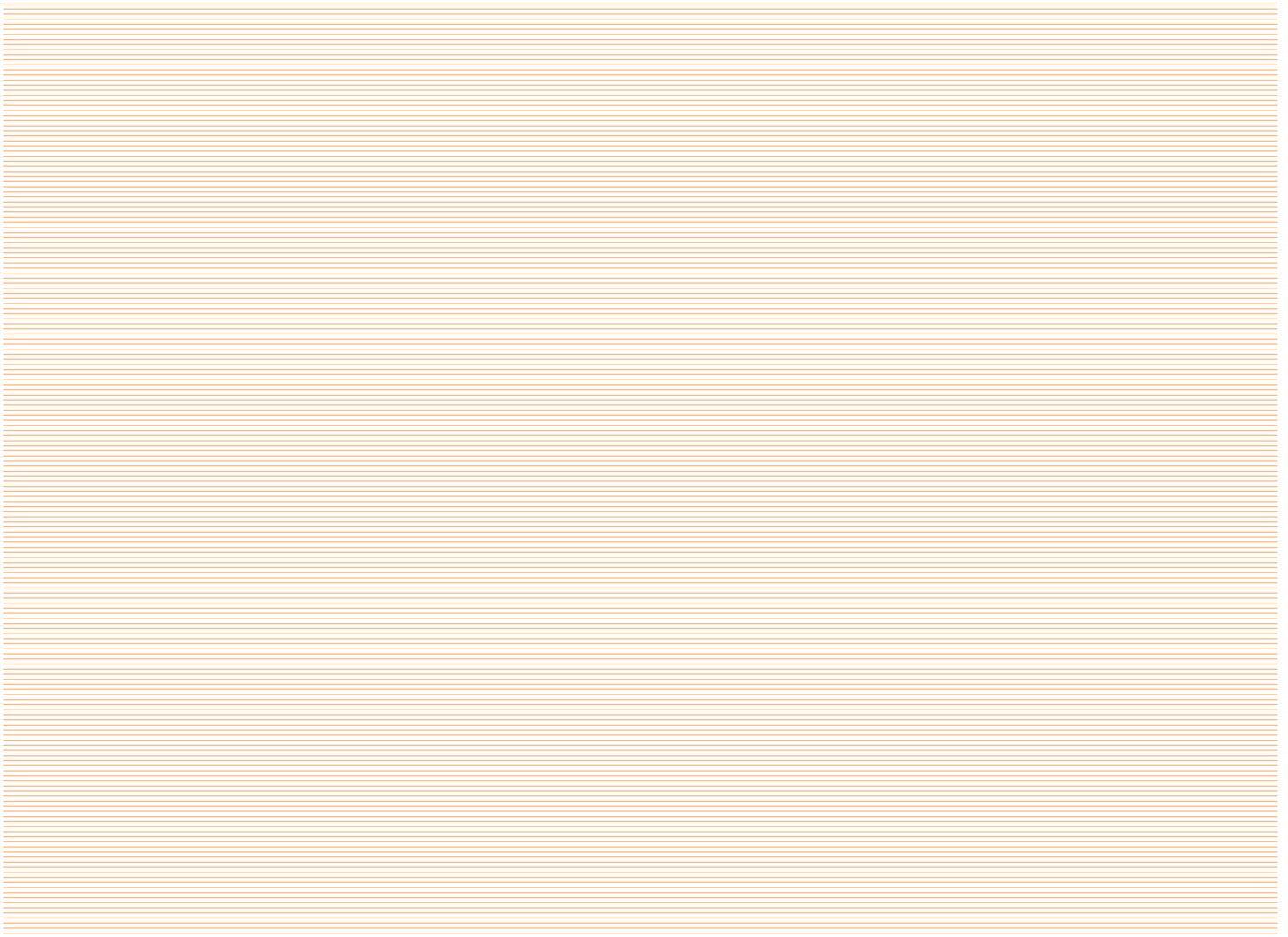

Retractors

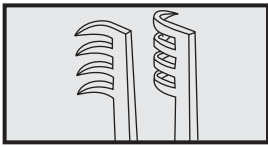

Fig. 2 = 22 X 15 mm
Fig. 1 = 19 X 15 mm

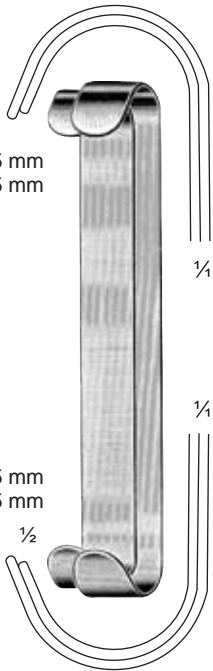

Fig. 1 = 19 X 15 mm
Fig. 2 = 22 X 15 mm

Parker
DC08-001-01 = Set
DC08-001-11 = Fig. 1
DC08-001-12 = Fig. 2
13.5 cm/5 1/4"

Fig. 2 = 27 X 25 mm
Fig. 1 = 24 X 25 mm



Parker
DC08-003-02 = Set
DC08-003-21 = Fig. 1
DC08-003-22 = Fig. 2
18 cm/7"

Fig. 1 = 26 X 25 mm
Fig. 2 = 29 X 25 mm

Fig. 2 = 25 X 24 mm
Fig. 1 = 21 X 24 mm

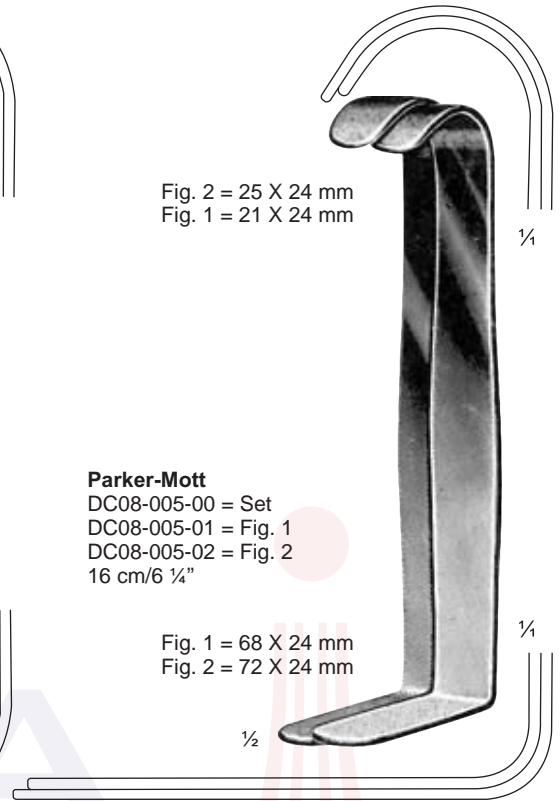

Parker-Mott
DC08-005-00 = Set
DC08-005-01 = Fig. 1
DC08-005-02 = Fig. 2
16 cm/6 1/4"

Fig. 1 = 68 X 24 mm
Fig. 2 = 72 X 24 mm

34 X 26 mm
52 X 33 mm

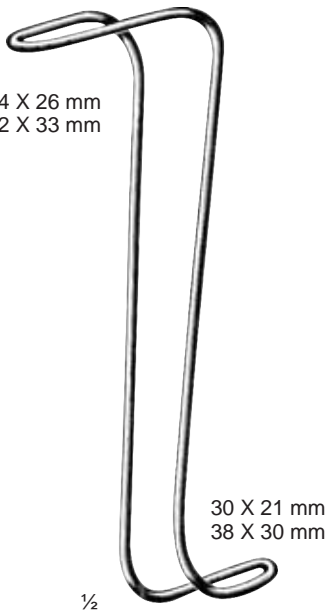

Collin-Hartmann
DC08-007-01 = 14 cm/5 1/2"
DC08-007-02 = 16 cm/6 1/4"

Fig. 1 = 24 X 20 mm
Fig. 2 = 29 X 26 mm
Fig. 3 = 35 X 29 mm
Fig. 4 = 27 X 24 mm

Fig. 1 = 30 X 28 mm
Fig. 2 = 36 X 36 mm
Fig. 3 = 38 X 43 mm
Fig. 4 = 42 X 28 mm

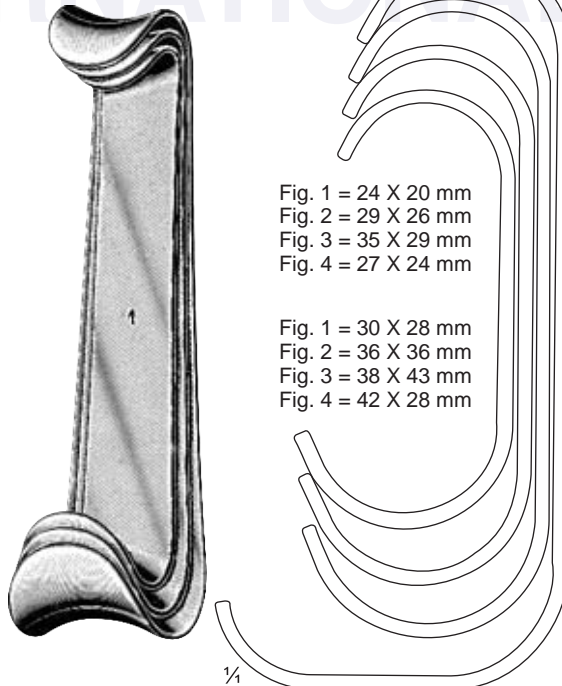

Roux
DC08-009-00 = Set Fig. 1-3
DC08-009-01 = Fig. 1 = 14 cm/5 1/2"
DC08-009-02 = Fig. 2 = 15 cm/6"
DC08-009-03 = Fig. 3 = 17 cm/6 3/4"
DC08-009-04 = Fig. 4 = 18 cm/7"

Fig. 1 = 24 X 20 mm
Fig. 2 = 29 X 26 mm
Fig. 3 = 35 X 39 mm
Fig. 4 = 27 X 24 mm

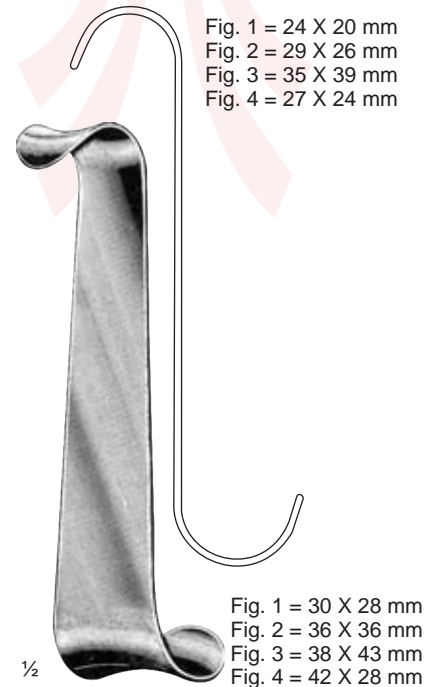

Roux-Magnus
DC08-011-00 = Set Fig. 1-3
DC08-011-01 = Fig. 1 = 14 cm/5 1/2"
DC08-011-02 = Fig. 2 = 15 cm/6"
DC08-011-03 = Fig. 3 = 17 cm/6 3/4"
DC08-011-04 = Fig. 4 = 18 cm/7"

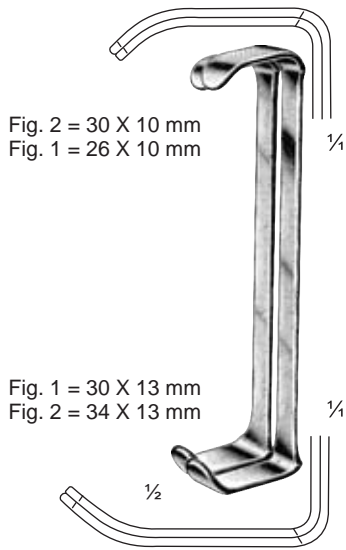

Fig. 2 = 30 X 10 mm
Fig. 1 = 26 X 10 mm

Fig. 1 = 30 X 13 mm
Fig. 2 = 34 X 13 mm

Farabeuf
DC08-013-00 = Set
DC08-013-01 = Fig. 1
DC08-013-02 = Fig. 2
12 cm/4 3/4"

Fig. 2 = 27 X 16 mm
Fig. 1 = 23 X 16 mm

Fig. 1 = 26 X 16 mm
Fig. 2 = 30 X 16 mm

Farabeuf
DC08-015-00 = Set
DC08-015-01 = Fig. 1
DC08-015-02 = Fig. 2
12 cm/4 3/4"

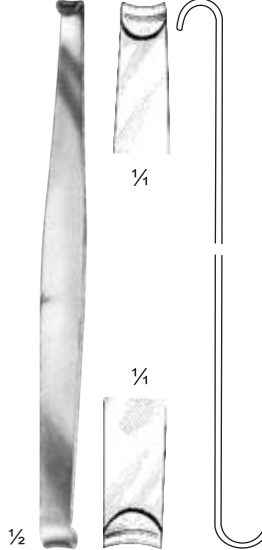
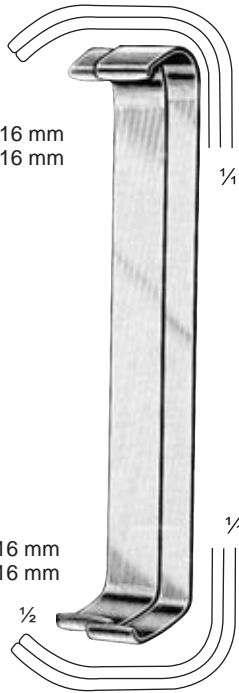

Mini-Roux
DC08-017-06

Baby-Roux
DC08-019-13
13 cm/5 1/4"

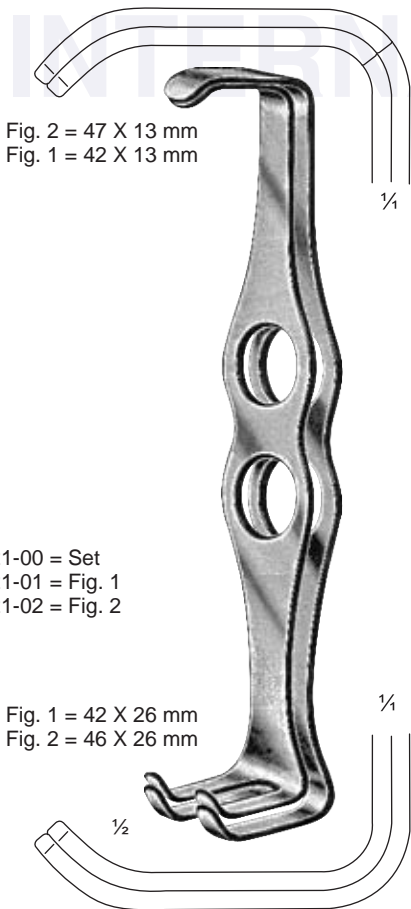

Fig. 2 = 47 X 13 mm
Fig. 1 = 42 X 13 mm

Mathieu
DC08-021-00 = Set
DC08-021-01 = Fig. 1
DC08-021-02 = Fig. 2
20 cm/8"

Fig. 1 = 42 X 26 mm
Fig. 2 = 46 X 26 mm

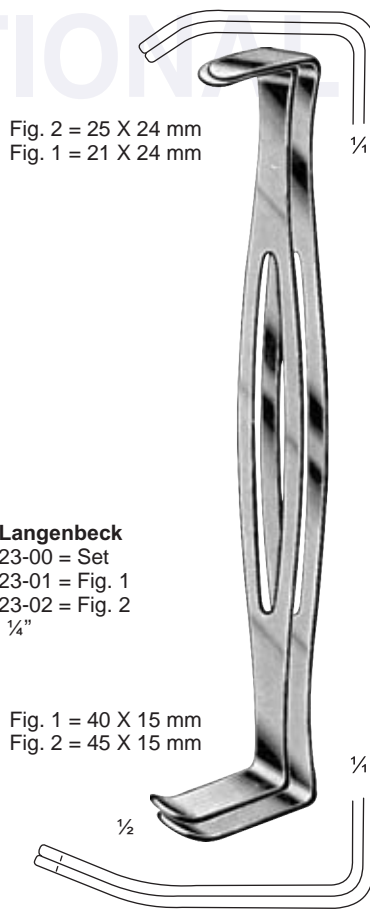

Fig. 2 = 25 X 24 mm
Fig. 1 = 21 X 24 mm

Parker-Langenbeck
DC08-023-00 = Set
DC08-023-01 = Fig. 1
DC08-023-02 = Fig. 2
21 cm/8 1/4"

Fig. 1 = 40 X 15 mm
Fig. 2 = 45 X 15 mm



37 X 40 mm

Goelet
DC08-025-00
19 cm/7 1/2"

30 X 31 mm

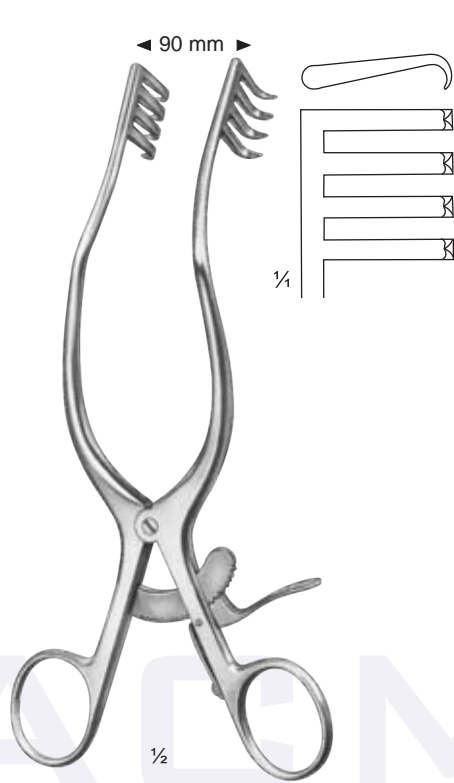
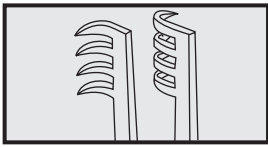

Anderson-Adson
DC08-027-20
19.5 cm/8"

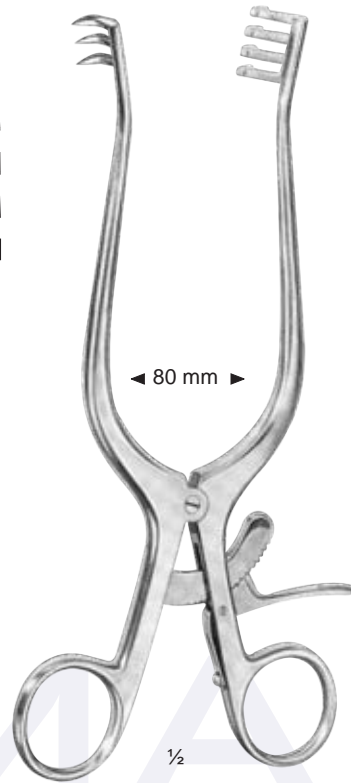

Weitlaner
DC08-029-20
20 cm/8"

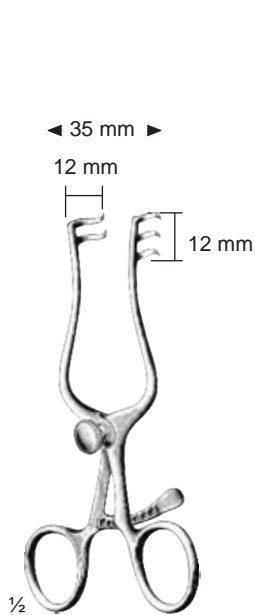
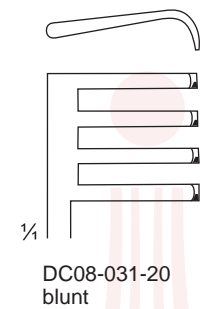
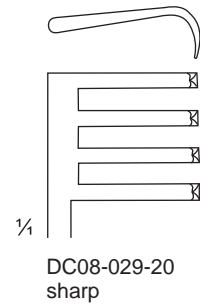

Weitlaner
DC08-033-10 sharp
DC08-035-10 blunt
10.5cm/4 1/4"

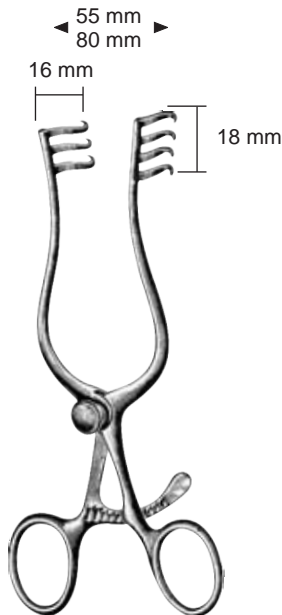

Weitlaner

	sharp	cm	in.	blunt
DC08-037-13		13.0	5	DC08-039-13
DC08-037-16		16.5	6 1/2	DC08-039-16

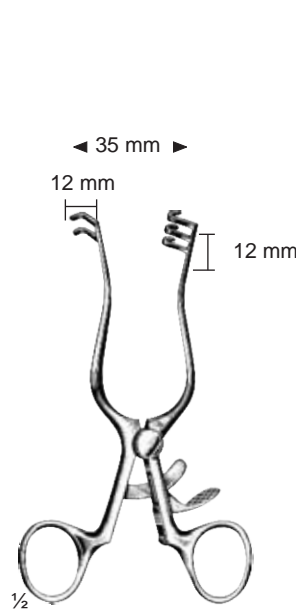

Weitlaner-Loktite
DC08-041-10 sharp
DC08-043-10 blunt
10.5cm/4 1/4"

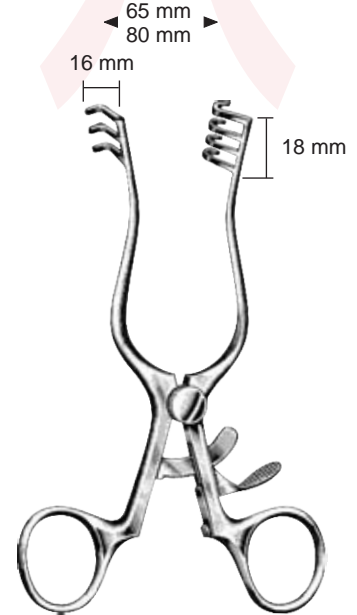

Weitlaner-Loktite

	sharp	cm	in.	blunt
DC08-045-13		13.0	5	DC08-047-13
DC08-045-16		16.5	6 1/2	DC08-047-16

Retractors

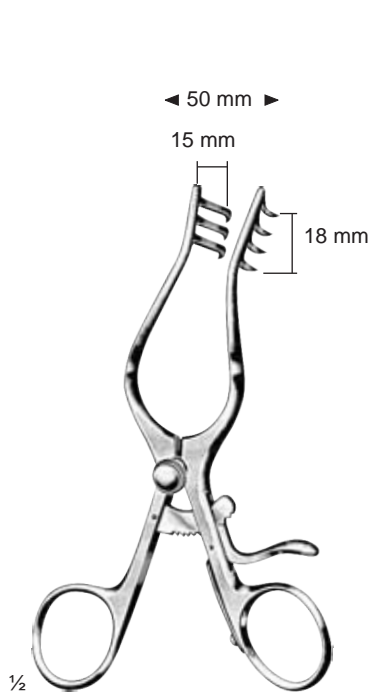
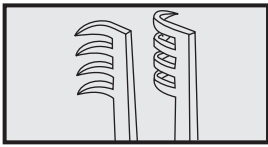

Weitlaner-Wullstein
DC08-049-13 sharp
DC08-051-13 blunt
13 cm/5"

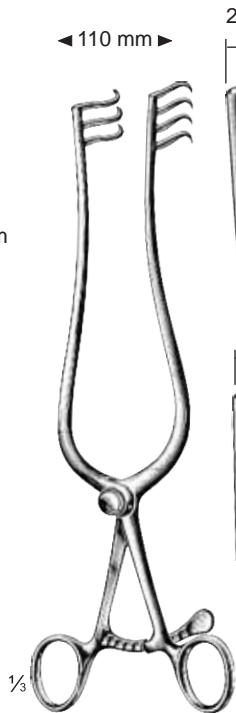

Weitlaner
DC08-053-26 sharp
DC08-055-26 blunt
26 cm/10 1/4"

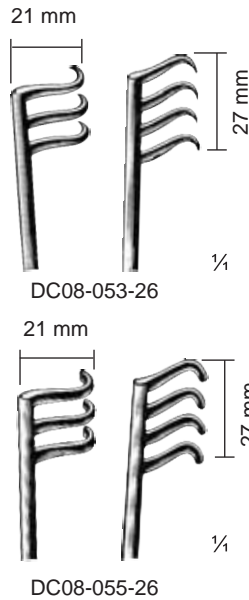

DC08-053-26

DC08-055-26

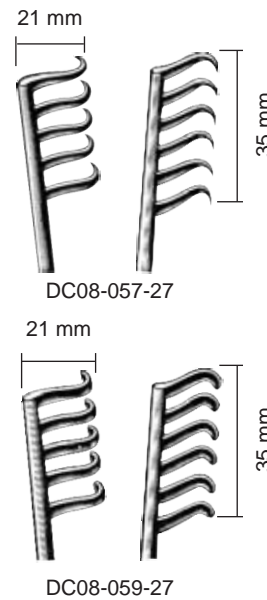

DC08-057-27

DC08-059-27

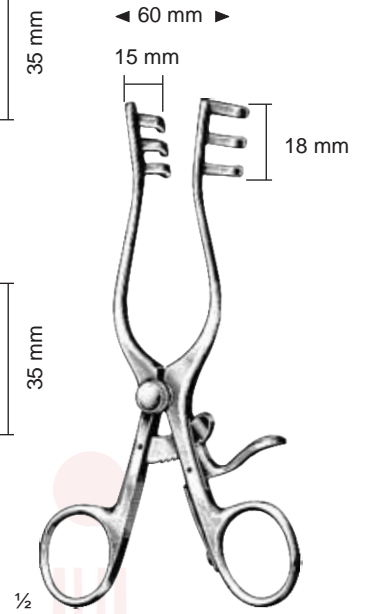

Milligan
13 cm/5"
DC08-061-13 blunt

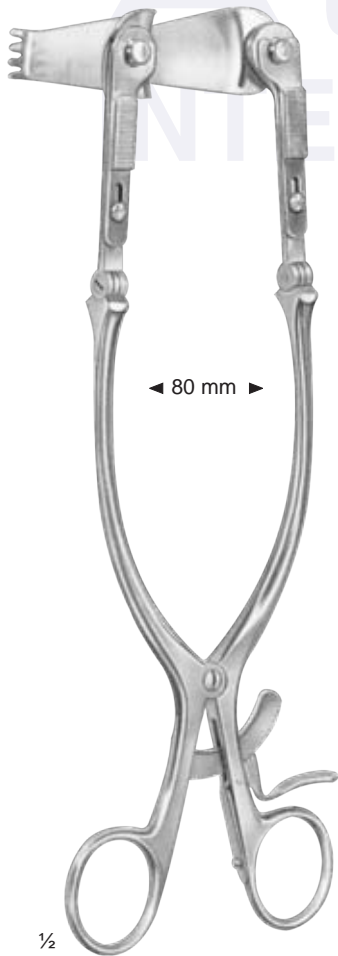

Cloward

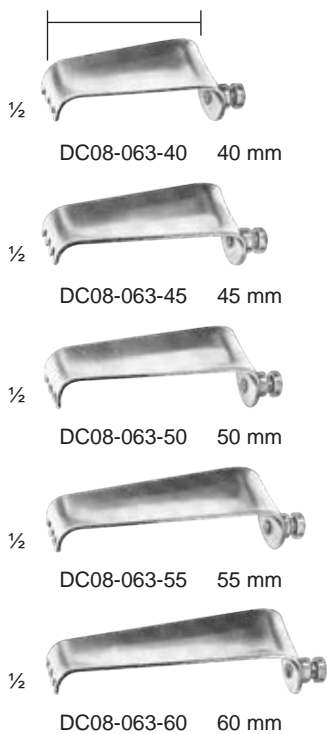

DC08-063-40 40 mm

DC08-063-45 45 mm

DC08-063-50 50 mm

DC08-063-55 55 mm

DC08-063-60 60 mm

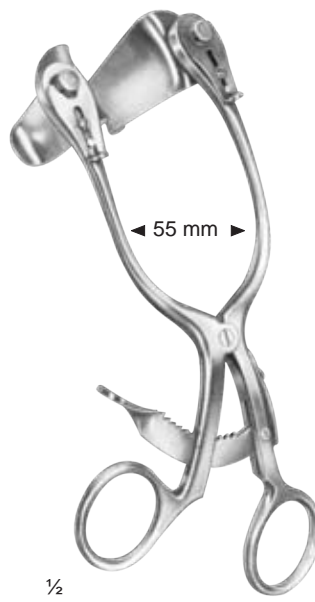

Cloward

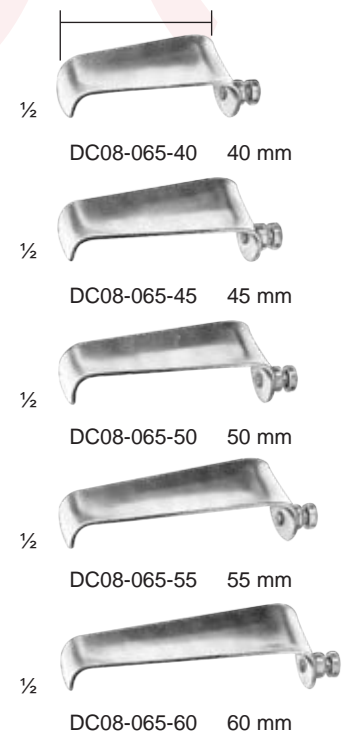

DC08-065-40 40 mm

DC08-065-45 45 mm

DC08-065-50 50 mm

DC08-065-55 55 mm

DC08-065-60 60 mm

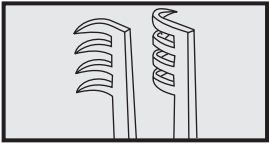

Adson
26.5 cm/10 1/2"

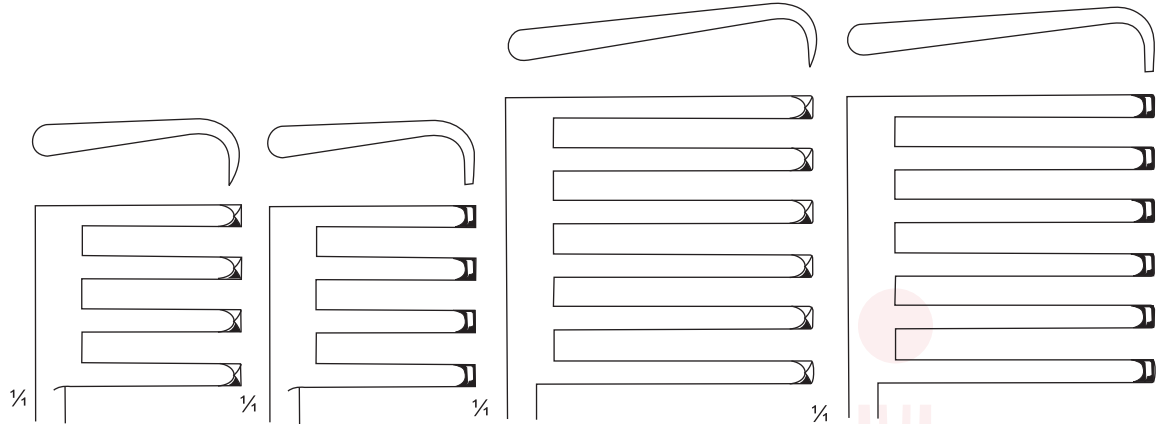

DC08-067-26
sharp
3 : 4 teeth

DC08-069-26
blunt
3 : 4 teeth

DC08-071-26
blunt
5 : 6 teeth

DC08-073-26
blunt
5 : 6 teeth



Weitlaner-Baby
DC08-075-13
13 cm/5"

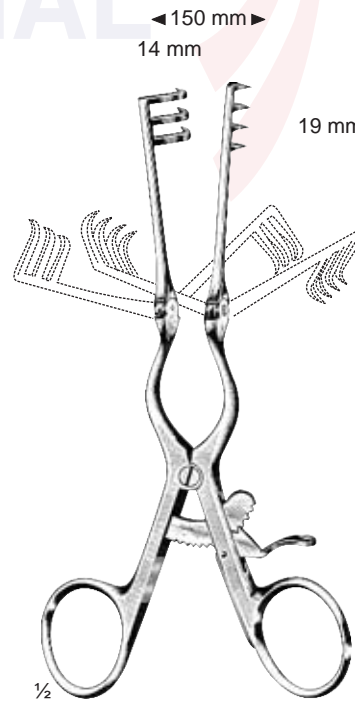

Adson-Baby
DC08-077-16 sharp
DC08-079-16 blunt
16 cm/6 1/2"

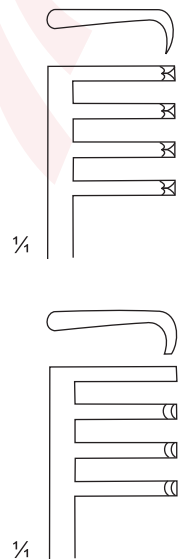



Retractors

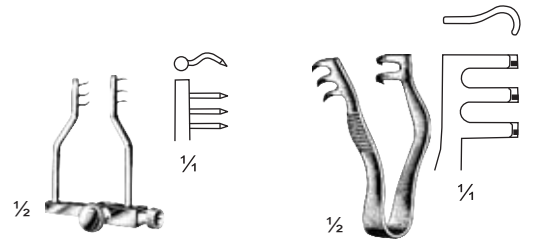

Logan
DC08-081-04
4 cm/1 1/2"

Finsen
DC08-082-05 sharp
DC08-083-05 blunt
5 cm/2"



Adson
DC08-084-32
32 cm/12 1/2"



Beckmann-Eaton
DC08-085-32
32 cm/12 1/2"

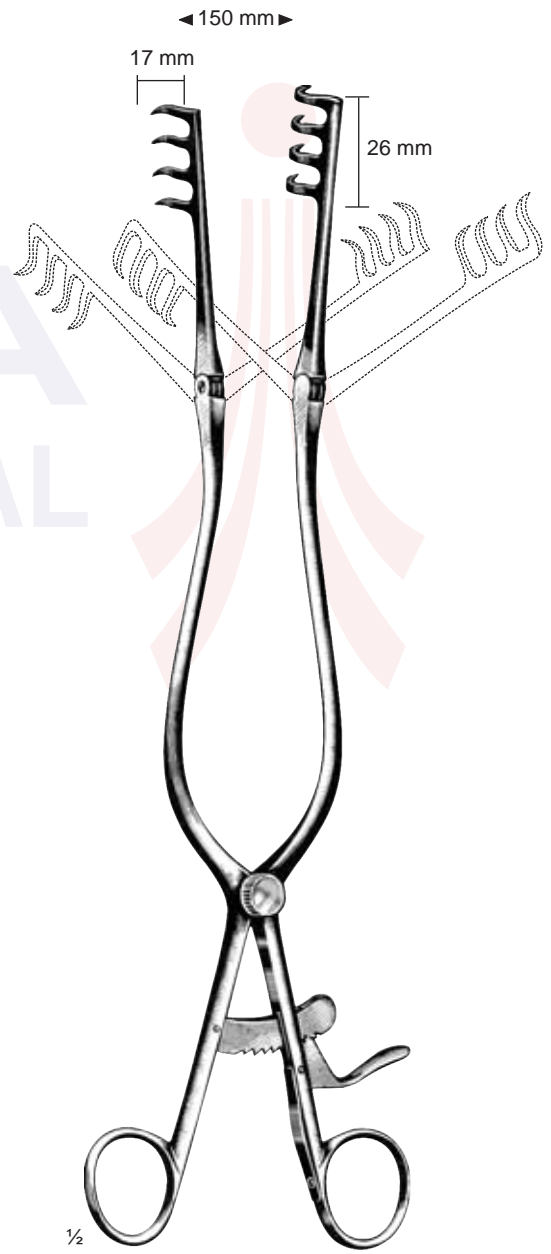

Beckmann
DC08-086-31
31 cm/12 1/4"

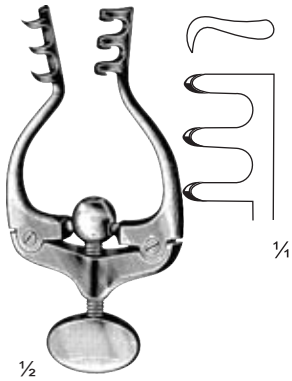
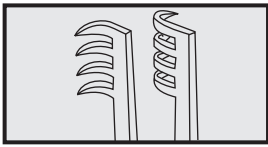

Jansen
DC08-087-10
10 cm/4"
sharp

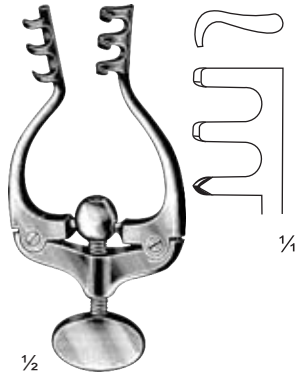

Jansen
DC08-088-10
10 cm/4"
with 1 sharp and
2 blunt prongs each

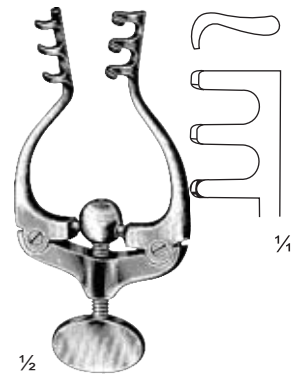

Jansen
DC08-089-10
10 cm/4"
blunt

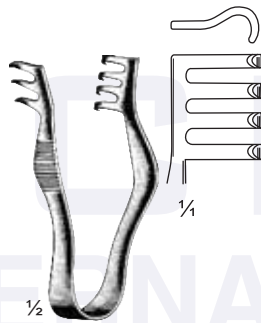

Finsen
DC08-090-07 sharp
DC08-091-07 blunt
7 cm/2 3/4"

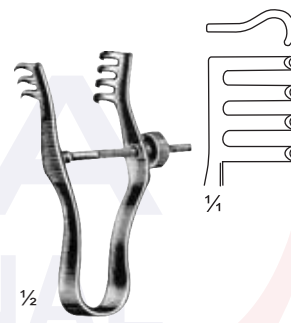

Finsen-Mod. Martin
DC08-093-07 sharp
DC08-095-07 blunt
7 cm/2 3/4"

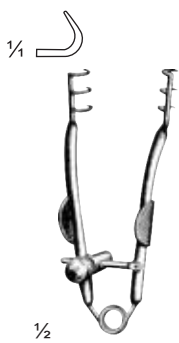

Buckley

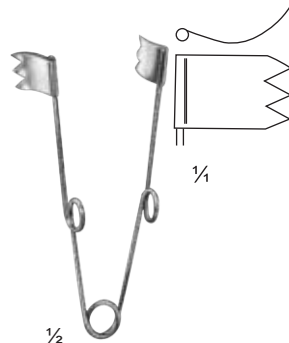

Alm

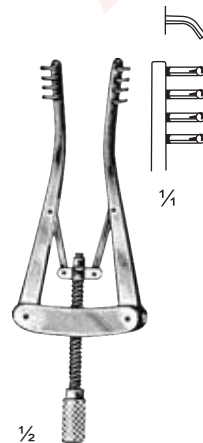

Semi-sharp



Blunt

cm	in.	Sharp	Sharp	Blunt	Semi-sharp	Blunt
6	2 1/4	DC08-097-06				
7	2 3/4		DC08-101-07	DC08-103-07		
8	3 1/4		DC08-099-08			
10	4		DC08-101-10	DC08-103-10	DC08-105-10	DC08-107-10

Abdominal Retractors

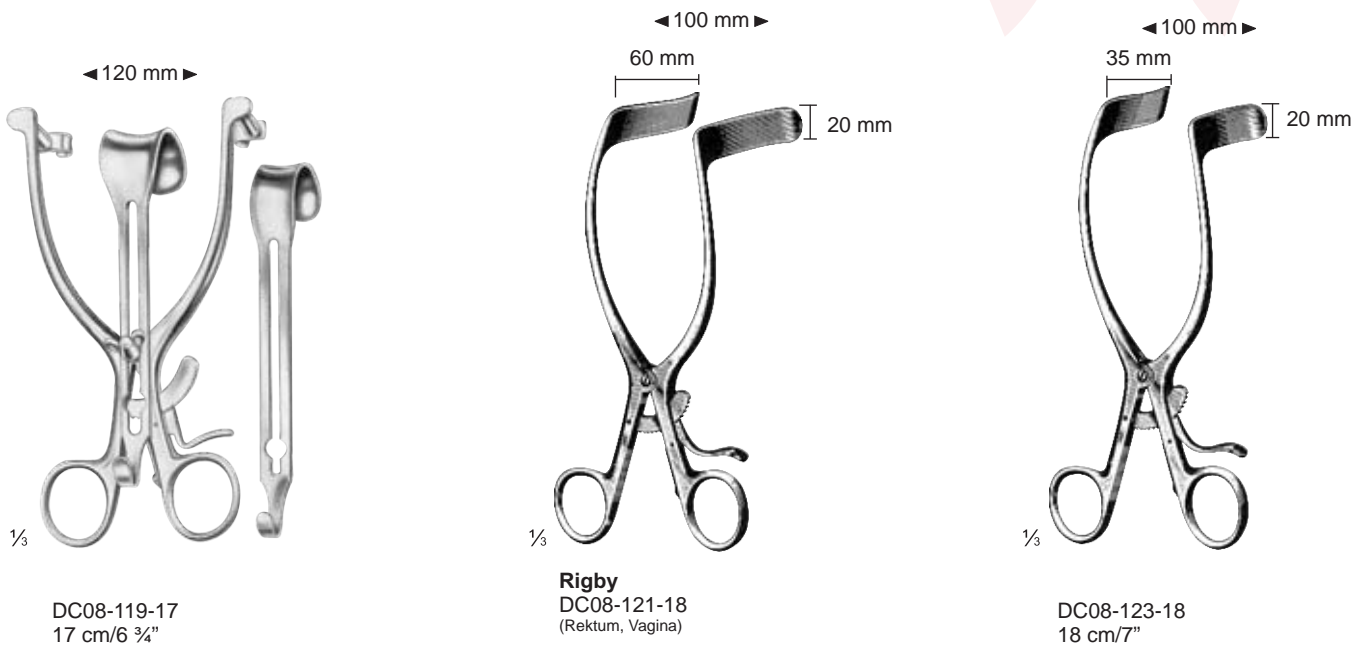
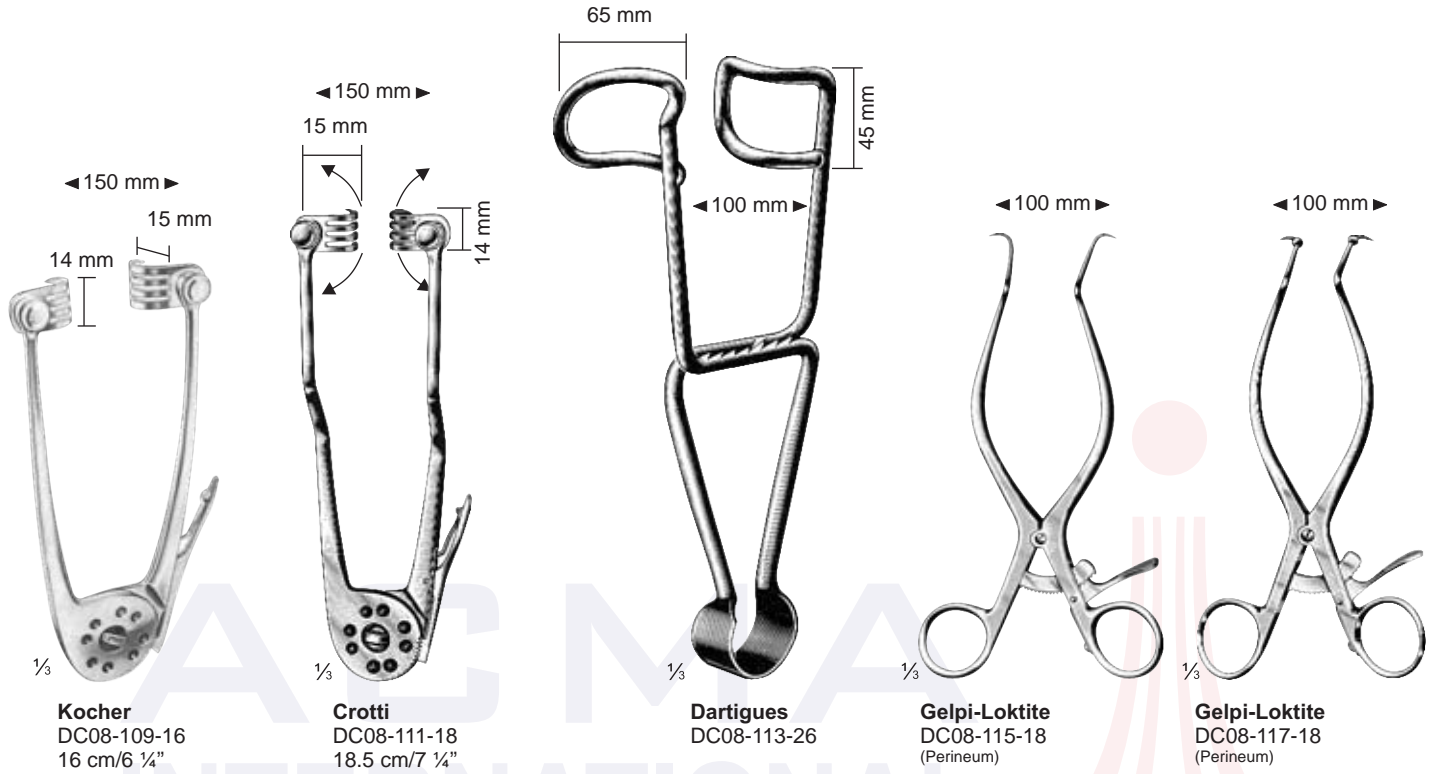
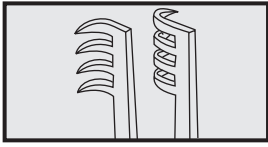

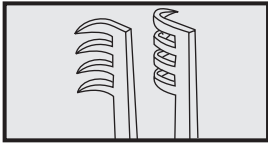

Abdominal Retractors

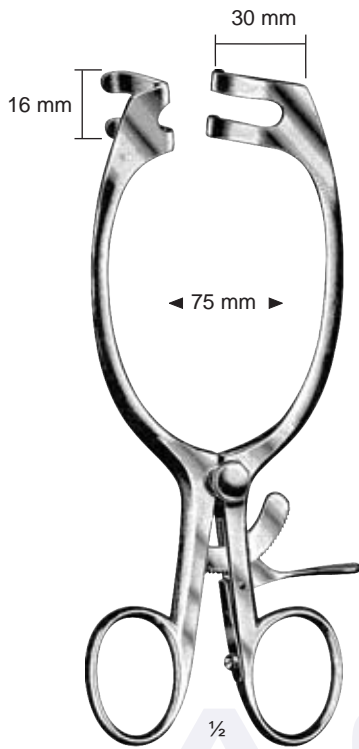

Mayo-Adams
DC08-125-17



Houzel
DC08-127-16

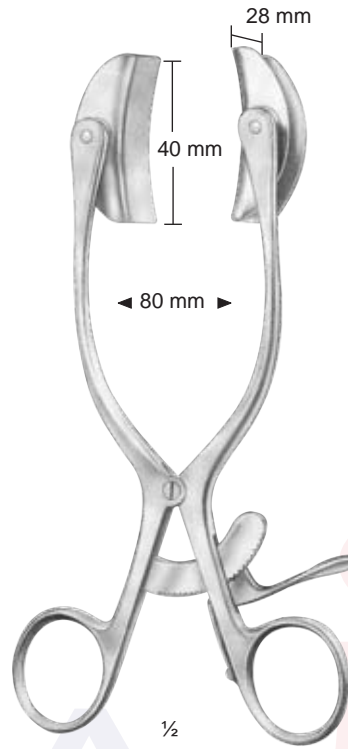

Baby-Collin
DC08-129-00
complete, with 2 pairs of blades

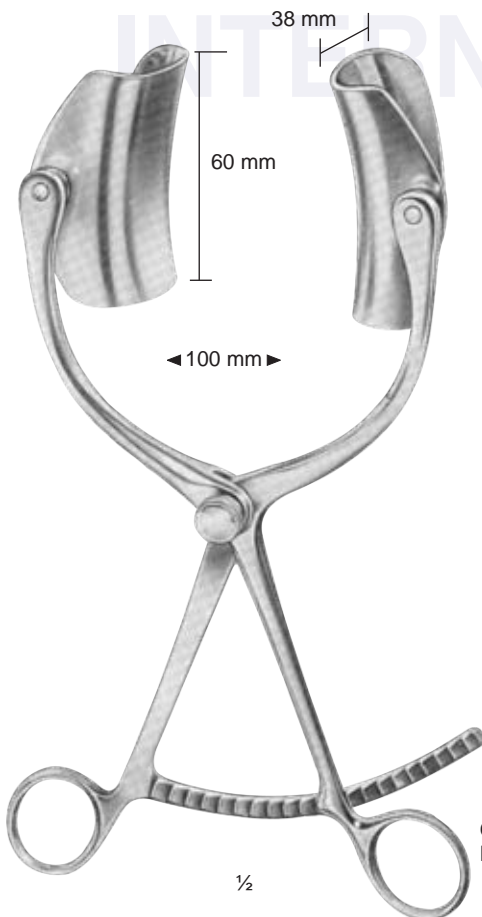
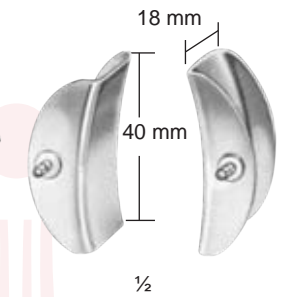
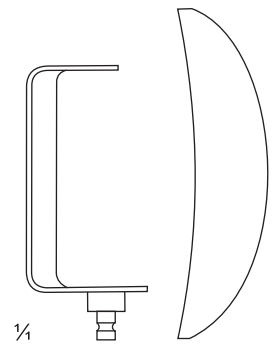

Collin
DC08-131-22

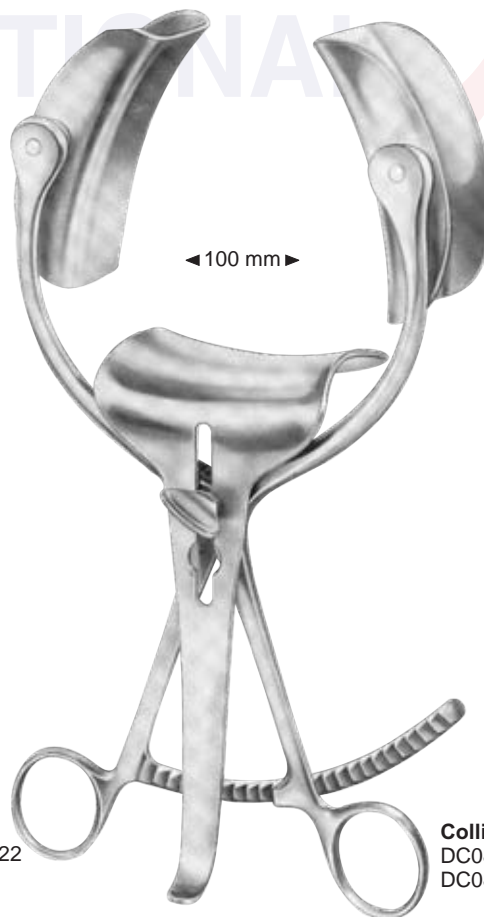

Collin
DC08-133-00 = 38 X 60 mm/38 X 55 mm
DC08-135-00 = 38 X 80 mm/50 X 75 mm

Measurements see below

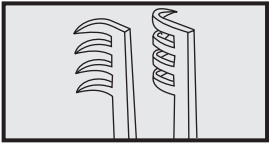

Exchangeable Blades

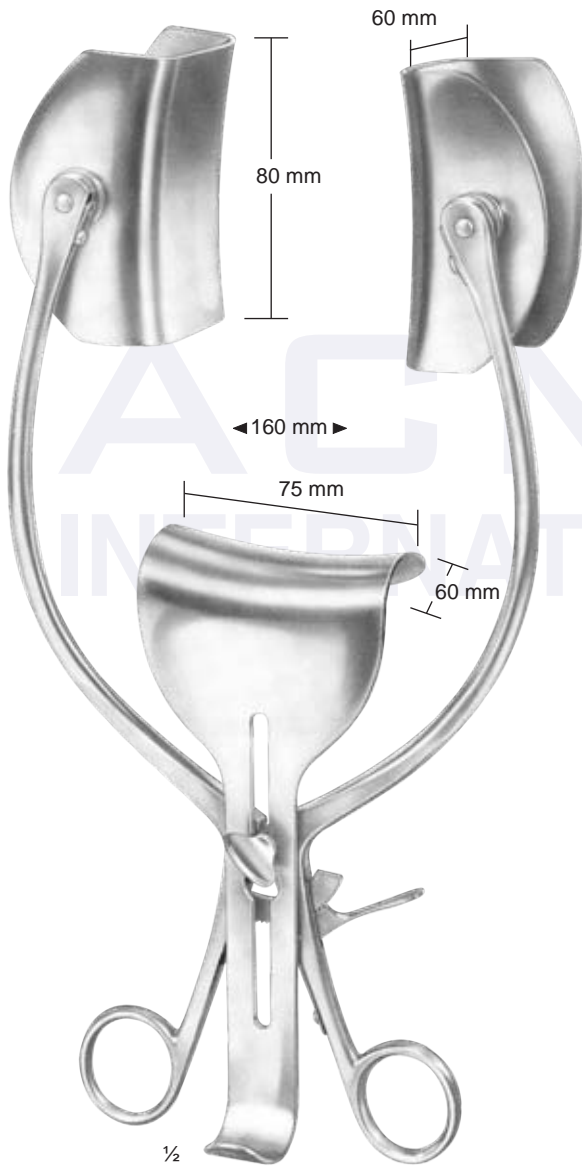

Collin-Loktite
DC08-137-00

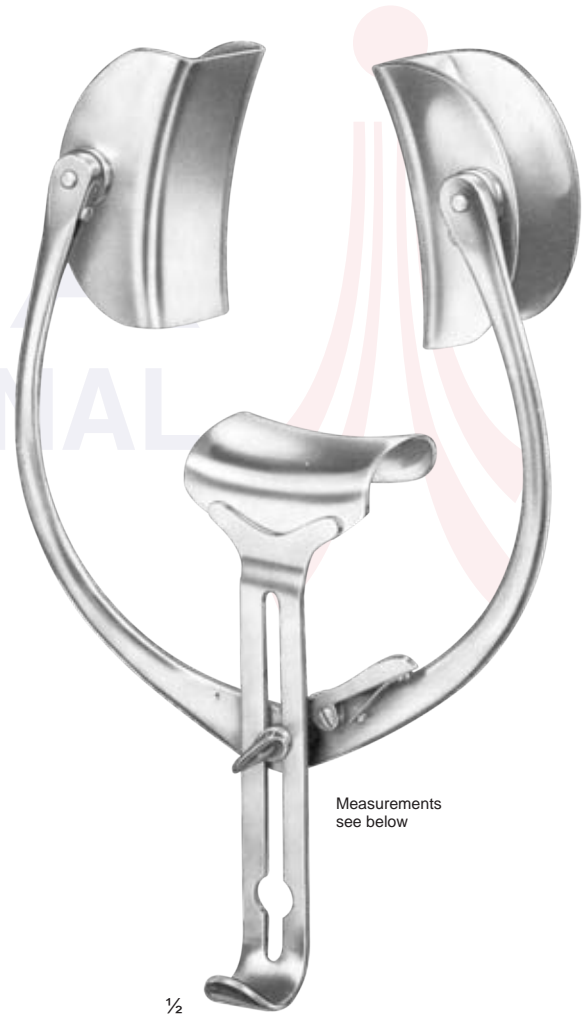

Measurements
see below

Robin-Masse	Lateral Blades	Central Blades	Opening width
DC08-139-00	= 40 X 80 mm/40 X 55 mm		160 mm

Ricard			
DC08-141-00	= 80 X 90 mm/80 X 90 mm		300 mm

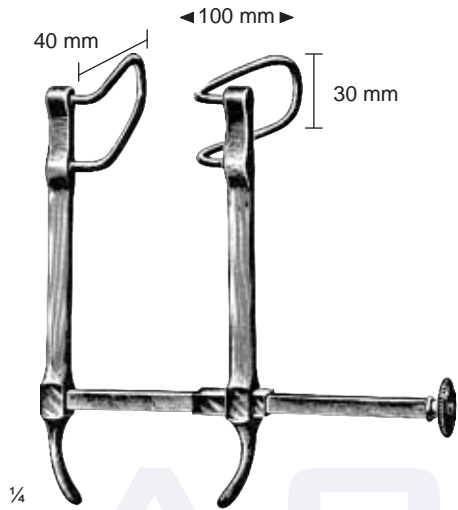
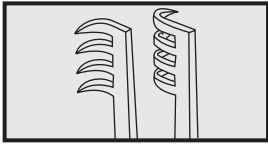

Gosset
DC08-143-00

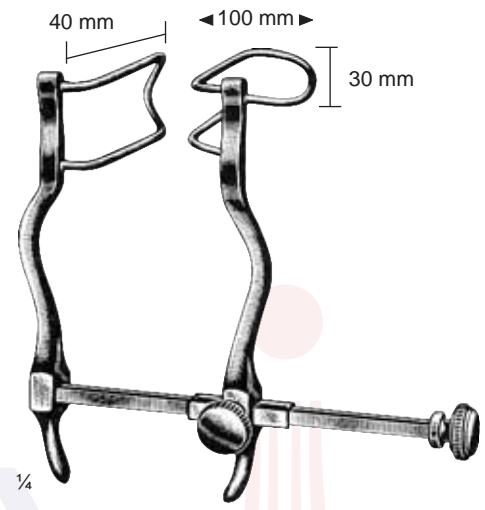

Gosset
DC08-145-00

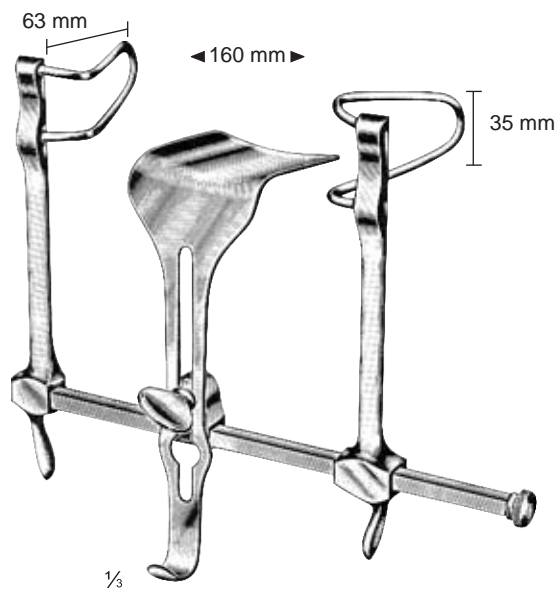

Gosset
DC08-147-00

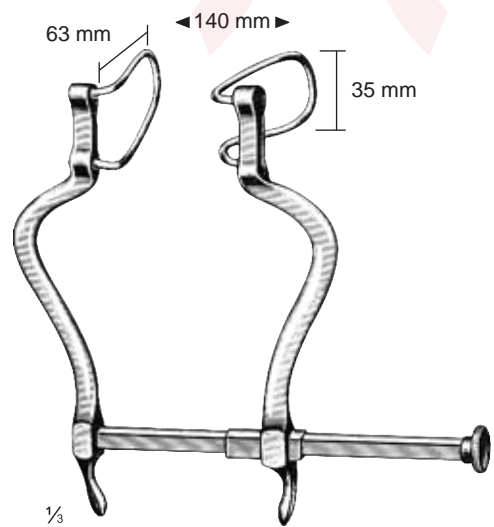

Gosset
DC08-149-00

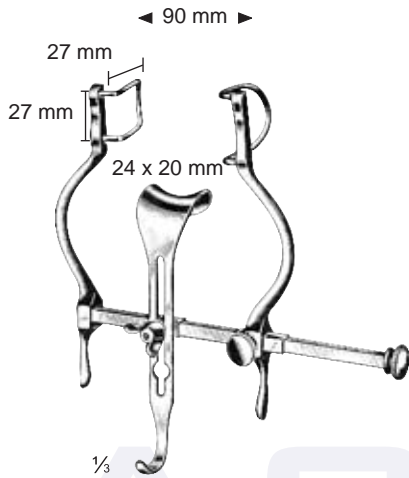
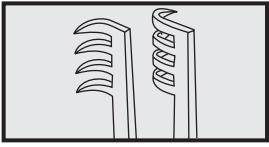

Balfour-Baby
DC08-151-00

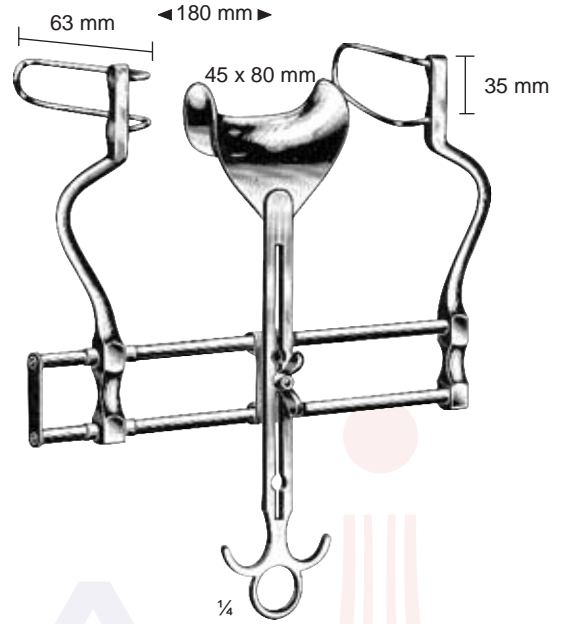

Balfour
DC08-153-00

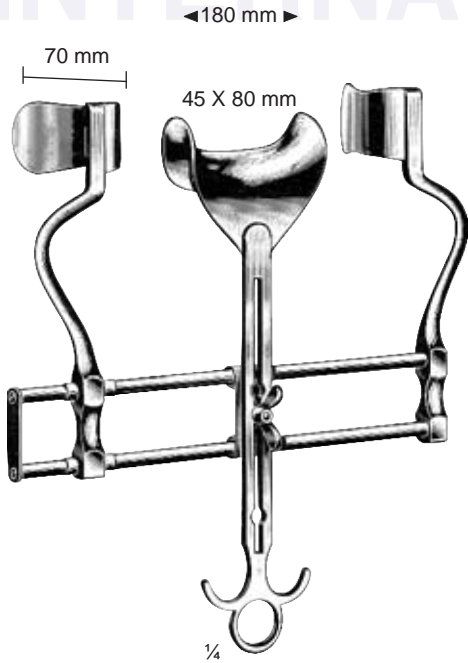

Balfour
DC08-155-00

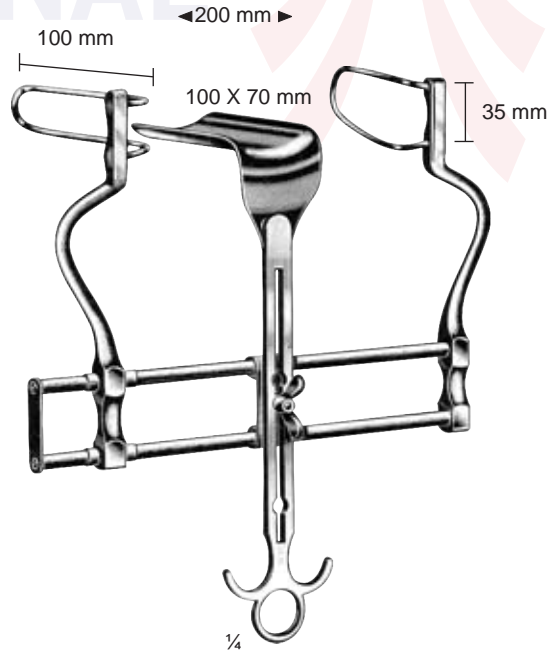

Balfour
DC08-157-00

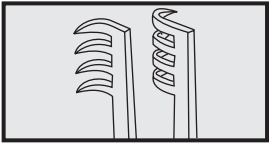

Abdominal Retractors

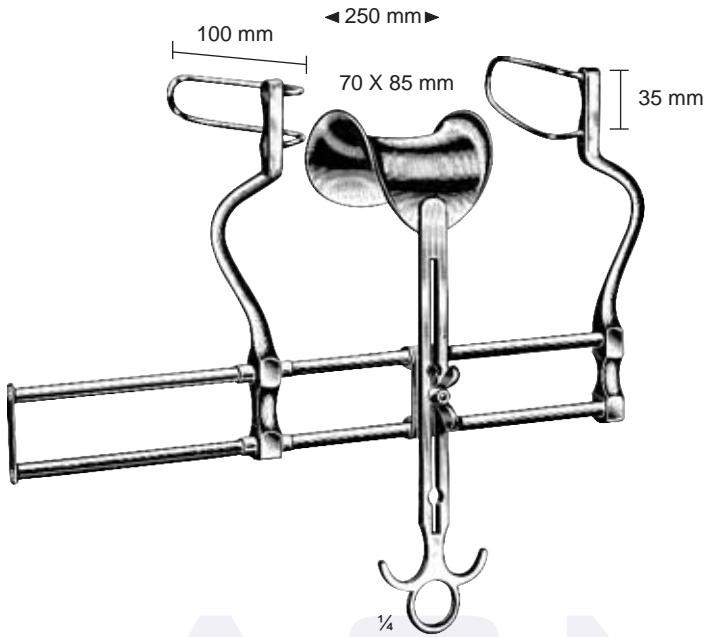

Balfour
DC08-159-00

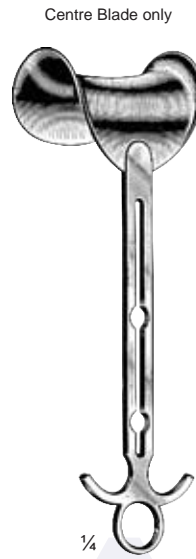

Balfour
DC08-161-01 = 45 X 80 mm
DC08-161-02 = 70 X 85 mm
DC08-161-03 = 80 X 90 mm



Doyen
DC08-163-02 = 55 X 095 mm
DC08-163-02 = 55 X 105 mm
DC08-163-03 = 55 X 115 mm
DC08-163-04 = 55 X 125 mm

ACMA
INTERNATIONAL

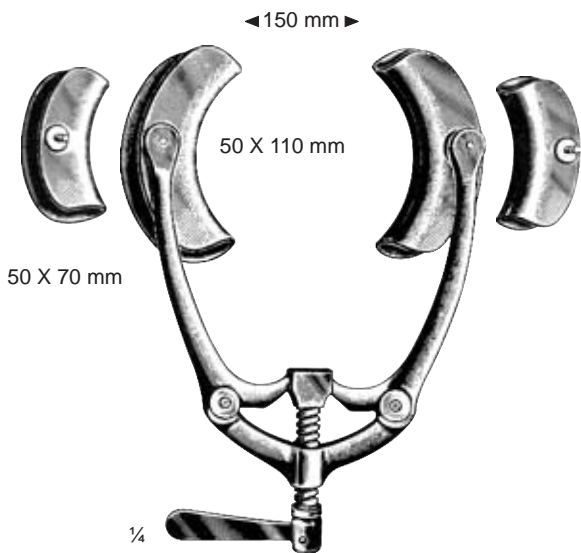

Qyervain
DC08-165-00

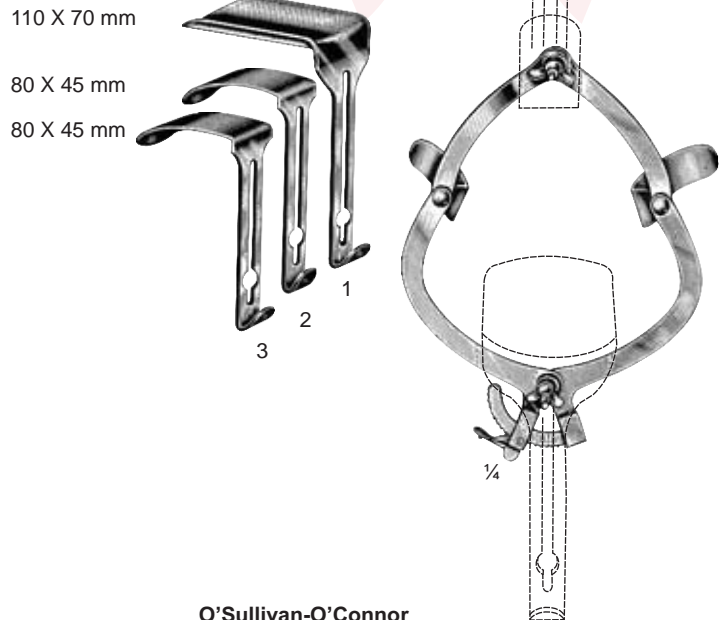

O'Sullivan-O'Connor
DC08-167-00

Abdominal Retractors

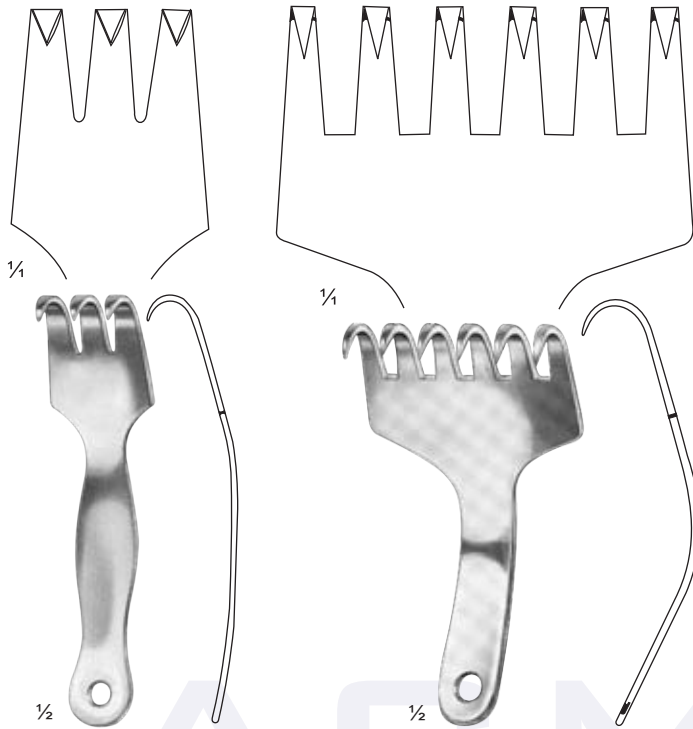

DC08-169-03
10.5 cm/4 1/4"
10 X 22 mm

DC08-169-06
10.5 cm/4 1/4"
15 X 55 mm

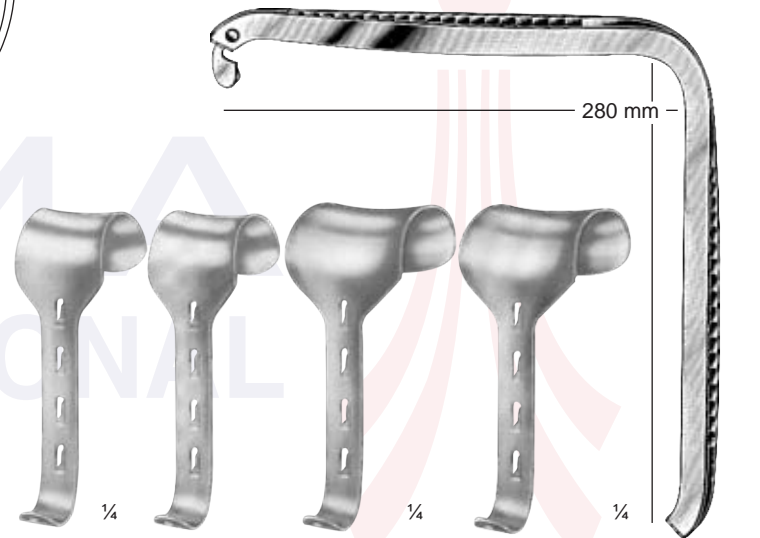

DC08-175-40
40 x 55 mm

DC08-175-50
50 x 65 mm

DC08-173-28

Kirschner
DC08-173-00

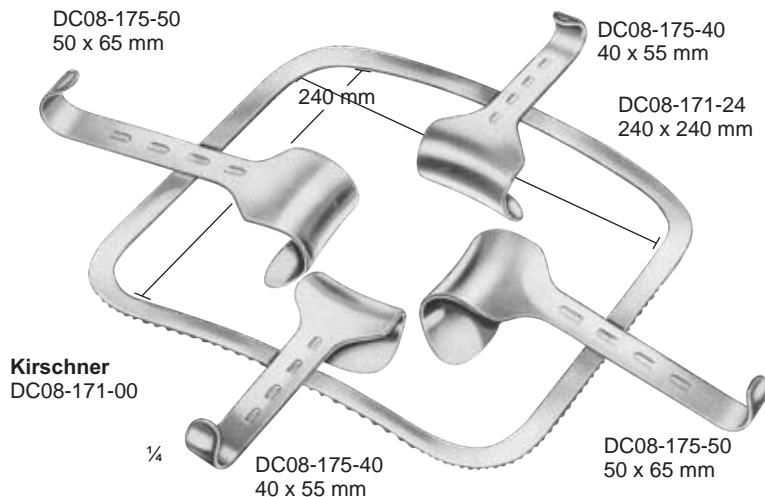

Kirschner
DC08-171-00

DC08-175-50
50 x 65 mm

DC08-175-40
40 x 55 mm

DC08-171-24
240 x 240 mm

DC08-175-40
40 x 55 mm

DC08-175-50
50 x 65 mm

- DC08-171-00 - Kirschner Abdominal Retractor, complete, consisting of:**
 DC08-171-24 - Frame, rigid, 240 x 240 mm
 DC08-175-40 - 2 Hook-on Retractors, 40 x 55 mm
 DC08-175-50 - 2 ditto, 50 x 65 mm
 DC08-171-24 - Frame only, rigid, 240 x 240 mm
DC08-173-00 - Kirschner Abdominal Retractor, folding, large size, complete, consisting of:

- DC08-173-28 - 1 Frame, folding type, large size, 280 x 280 mm
 DC08-175-40 - 2 Hook-on Retractors, 40 x 55 mm
 DC08-175-50 - 2 ditto, 50 x 65 mm
 DC08-173-28 - Frame only, folding type, 280 x 280 mm

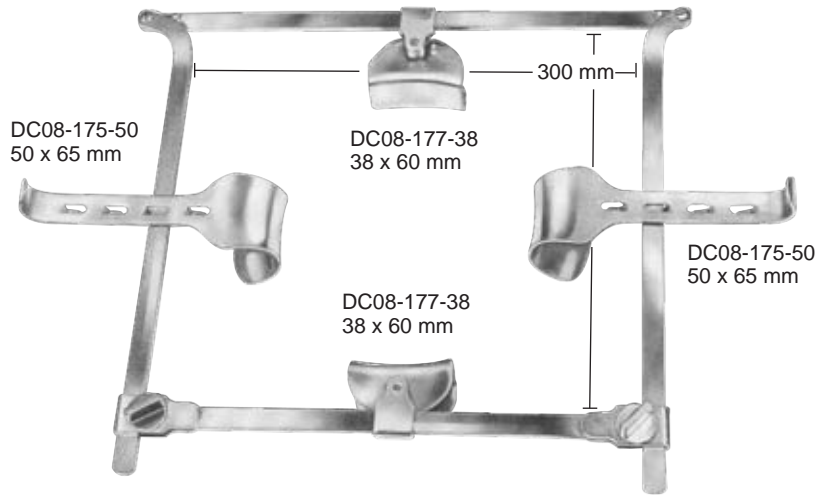
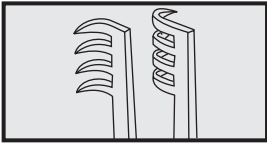

Franz (complete)
 DC08-179-00 with 4 blades
 DC08-181-00 with 8 blades

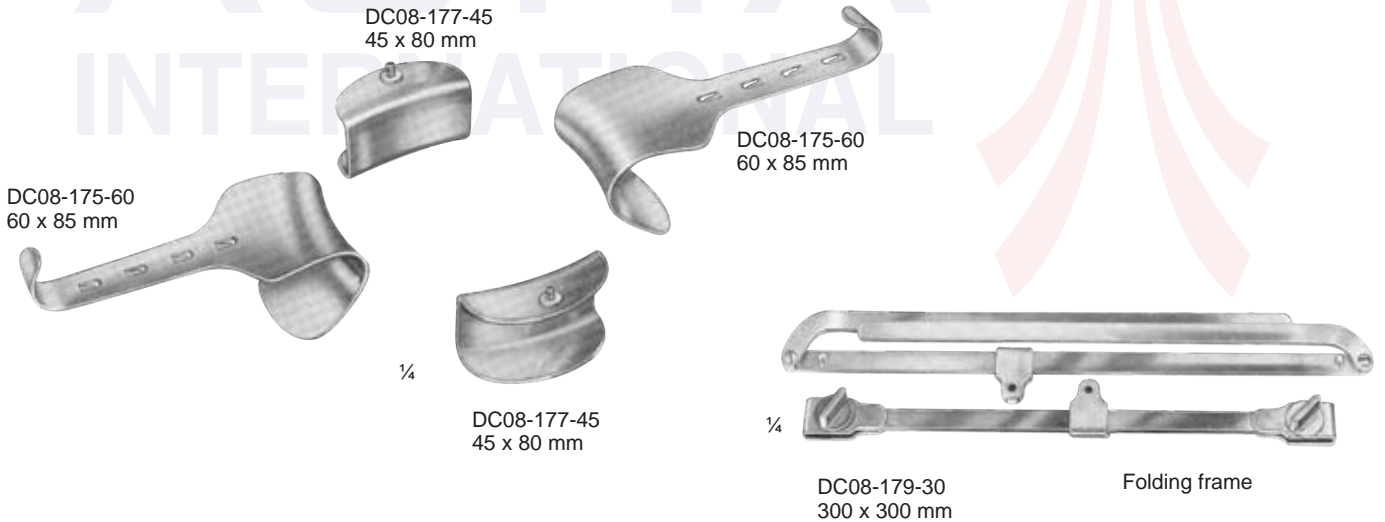

- DC08-179-00** - Franz Abdominal Retractor, folding, complete, consisting of:
- DC08-179-30 - 1 frame, folding, 300 x 300 mm
 - DC08-175-50 - 2 hook-on retractors, 50 x 65 mm
 - DC08-177-38 - 2 exchangeable blades 38 x 6 mm
 - DC08-179-30 - Frame, folding, only, 300 x 300 mm

- DC08-181-00** - Franz Abdominal Retractor, folding, complete, consisting of:
- DC08-179-30 - 1 frame, folding, 300 x 300 mm
 - DC08-175-50 - 2 hook-on retractors, 50 x 65 mm
 - DC08-175-60 - 2 ditto, 60 x 85 mm
 - DC08-177-38 - 2 exchangeable blades, 38 x 60 mm
 - DC08-177-45 - 2 ditto, 45 x 80 mm

Abdominal Retractors, Retractors

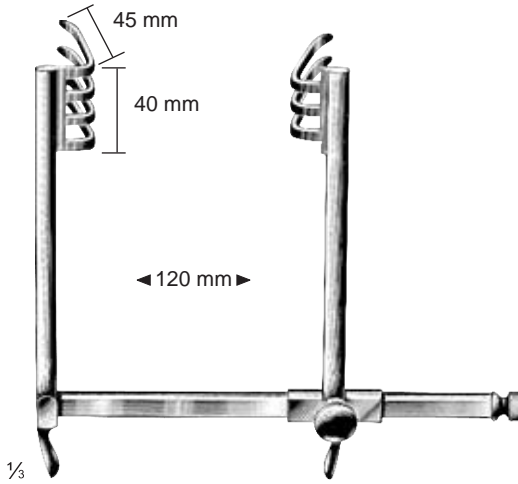
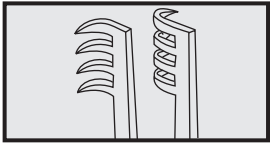

Temple-Fay
DC08-183-00

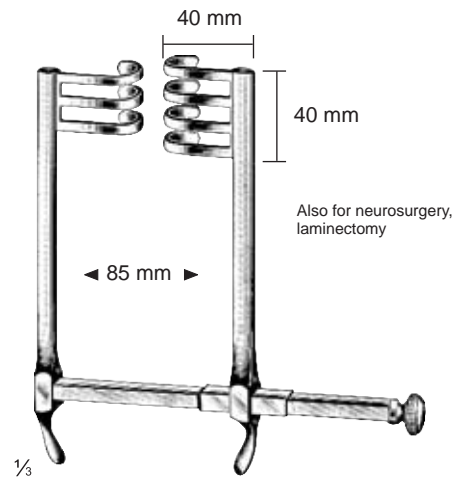

Frazier
DC08-185-00

Also for neurosurgery,
laminectomy



Doyen
DC08-187-25
25 cm/10"



Kocher
DC08-189-22
22 cm/9"



Kocher

	Total length cm	in.	Blade mm
DC08-191-01	25	10	80 X 45
DC08-191-02	25	10	80 X 55
DC08-191-03	25	10	80 X 65



Tuffier
DC08-193-23
23 cm/9"

Abdominal Retractors, Retractors

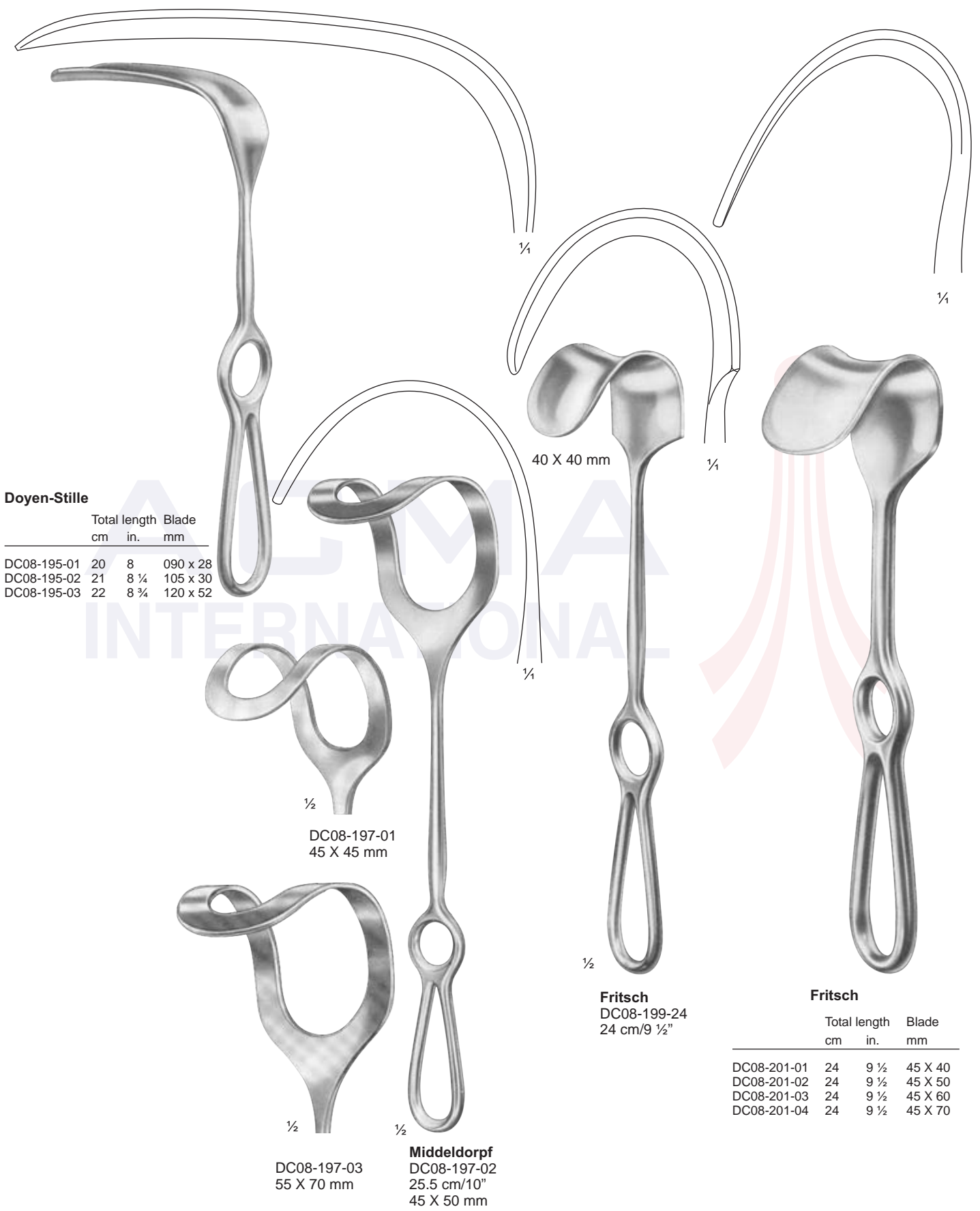
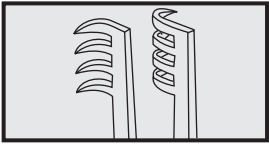

Doyen-Style

	Total length		Blade mm
	cm	in.	
DC08-195-01	20	8	090 x 28
DC08-195-02	21	8 ¼	105 x 30
DC08-195-03	22	8 ¾	120 x 52

DC08-197-01
45 X 45 mm

DC08-197-03
55 X 70 mm

Middeldorpf
DC08-197-02
25.5 cm/10"
45 X 50 mm

40 X 40 mm

Fritsch
DC08-199-24
24 cm/9 ½"

Fritsch

	Total length		Blade mm
	cm	in.	
DC08-201-01	24	9 ½	45 X 40
DC08-201-02	24	9 ½	45 X 50
DC08-201-03	24	9 ½	45 X 60
DC08-201-04	24	9 ½	45 X 70

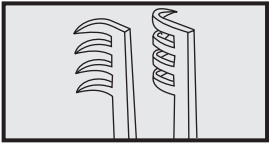

1/2
DC08-203-03
19 cm/7 3/4"



1/2
28 cm/11 1/4"

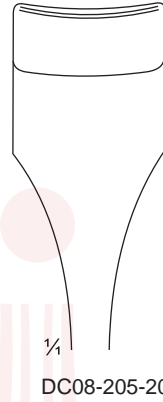

1/4
DC08-205-20

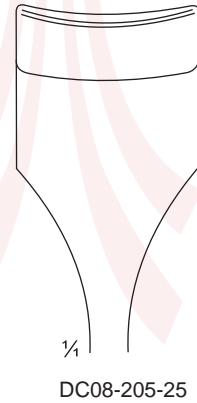

1/4
DC08-205-25

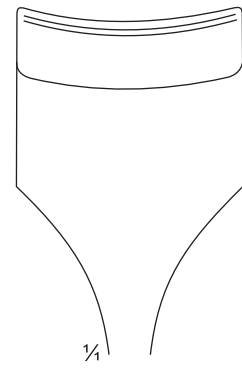

1/4
DC08-205-30

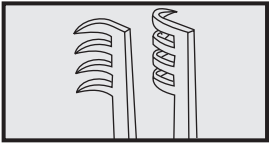

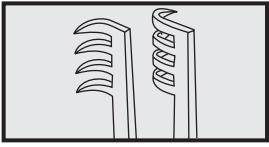

DC08-215-02
75 X 90 mm

1/2

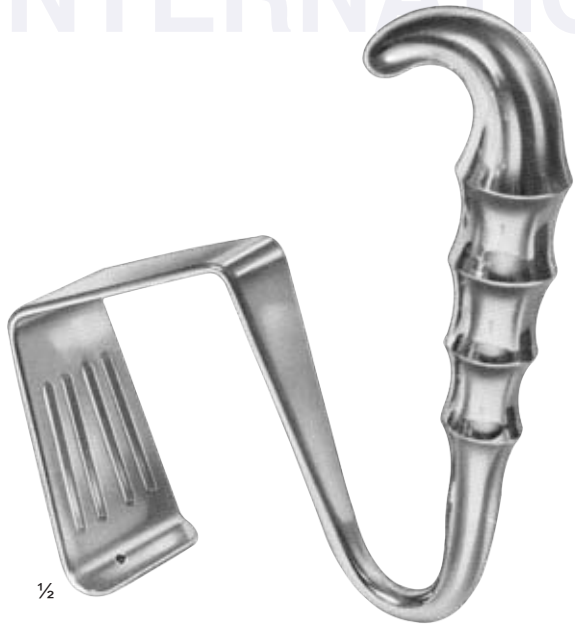

DC08-215-01
75 X 50 mm

1/2

Davidson
16 cm/6 1/4"
(Scapula)

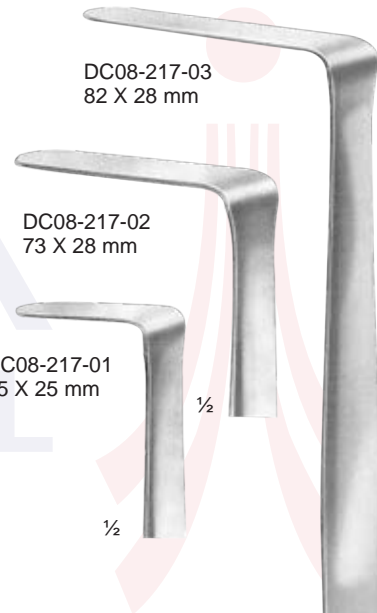

DC08-217-03
82 X 28 mm

DC08-217-02
73 X 28 mm

DC08-217-01
45 X 25 mm

1/2

1/2

1/2

Heaney
27 cm/10 1/2"

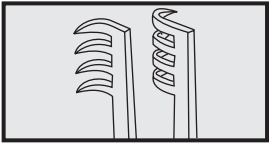

Retractors

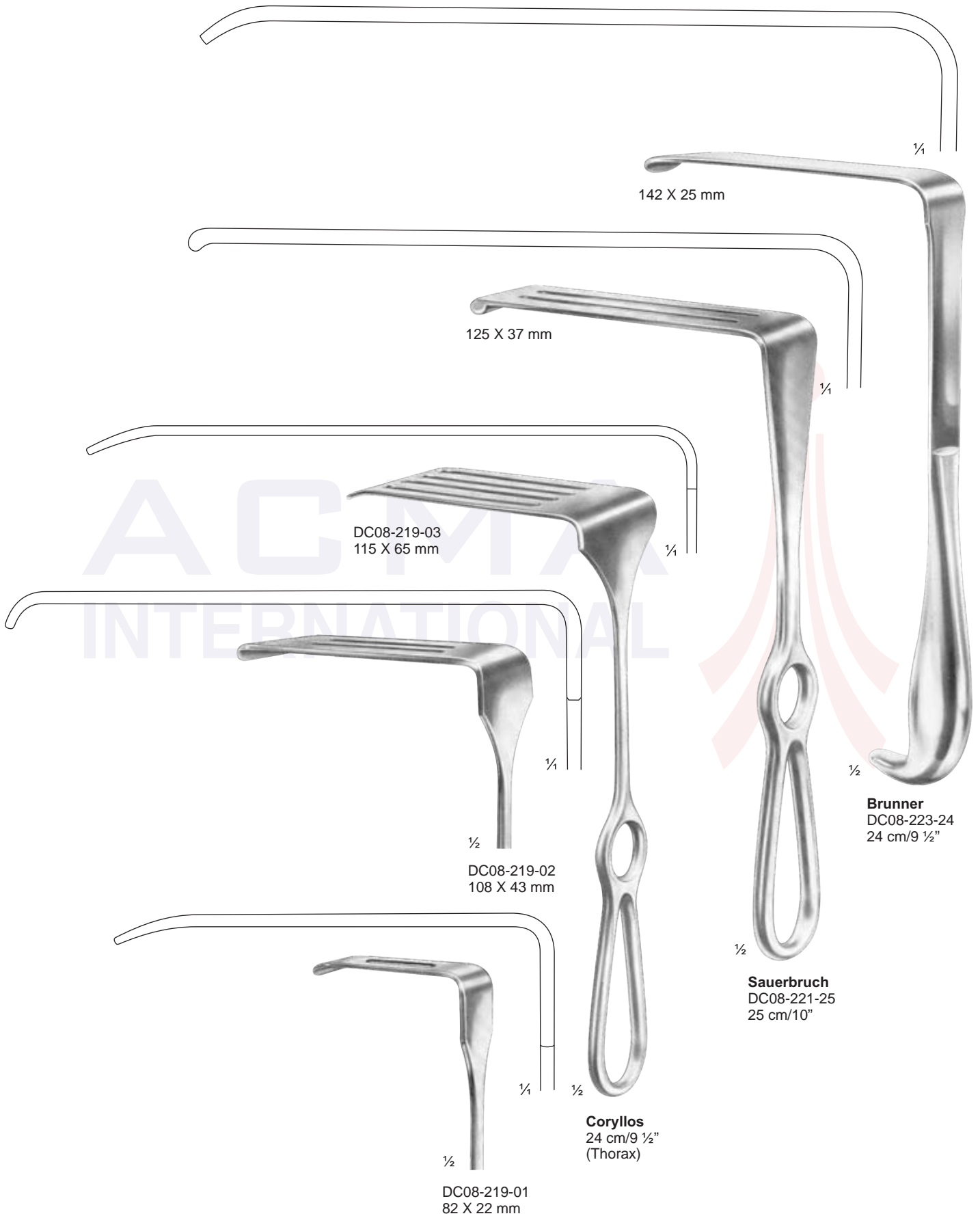

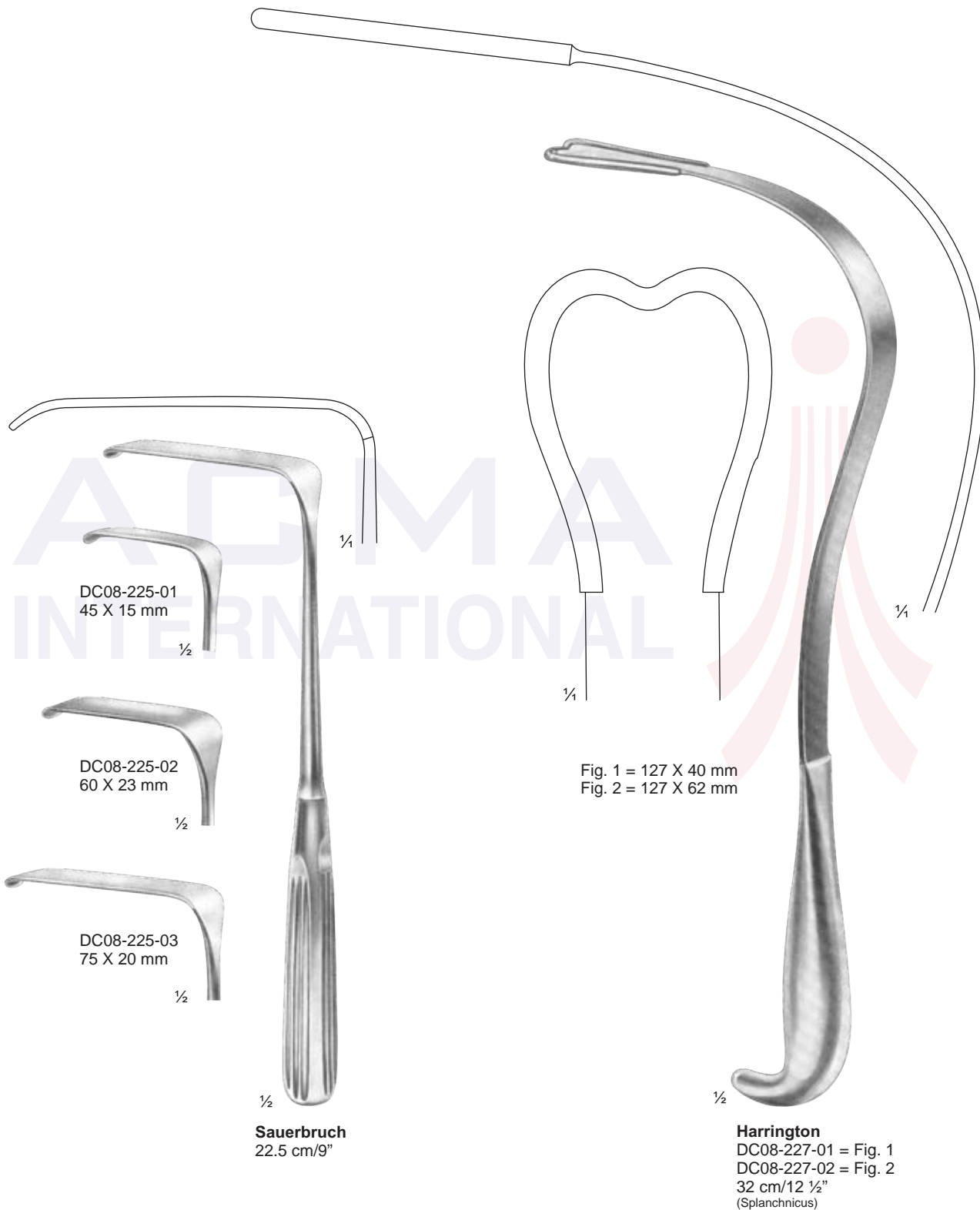
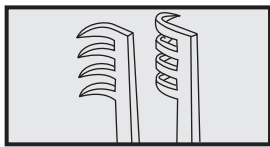

DC08-225-01
45 X 15 mm

DC08-225-02
60 X 23 mm

DC08-225-03
75 X 20 mm

Sauerbruch
22.5 cm/9"

Fig. 1 = 127 X 40 mm
Fig. 2 = 127 X 62 mm

Harrington
DC08-227-01 = Fig. 1
DC08-227-02 = Fig. 2
32 cm/12 1/2"
(Splanchnicus)

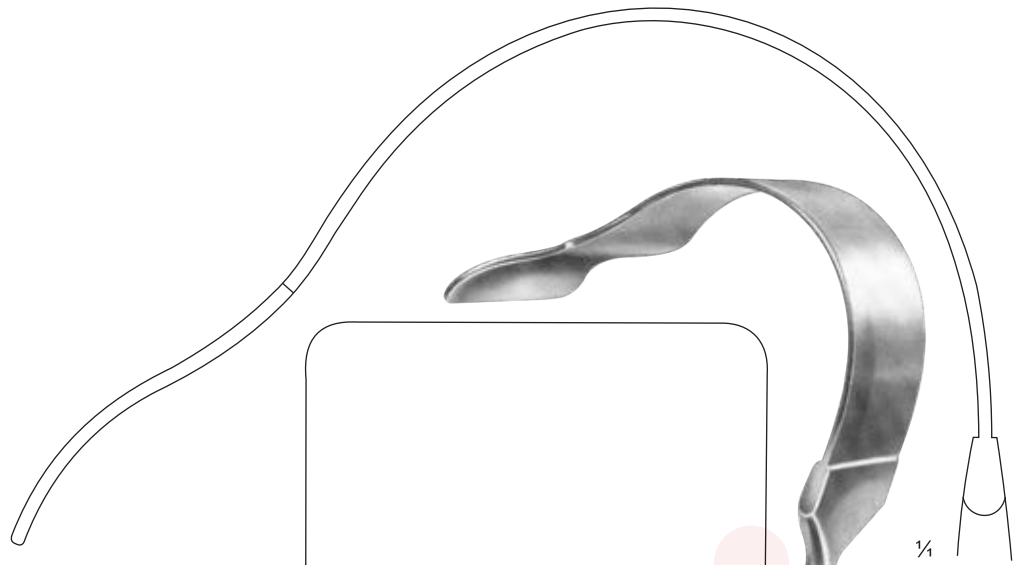
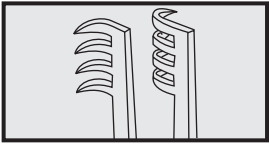

1/4



1/4

1/2

1/4

1/2

1/2

Polloson
DC08-229-27
27 cm/10 3/4"

Polloson
DC08-231-27
27 cm/9 3/4"

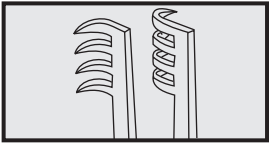

Retractors

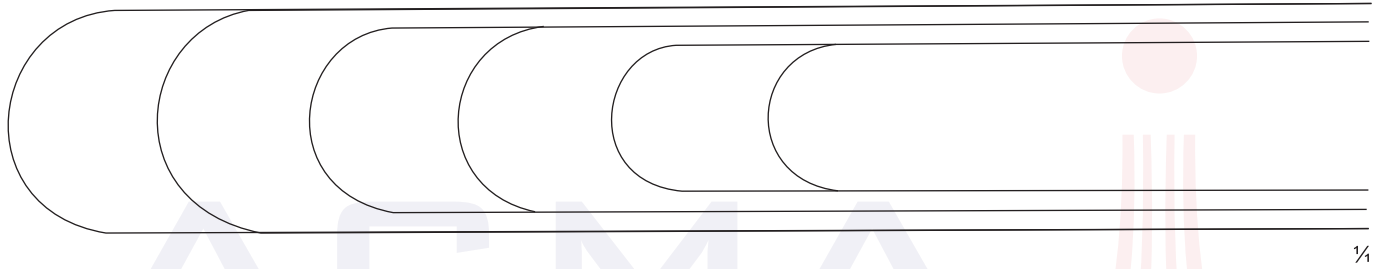
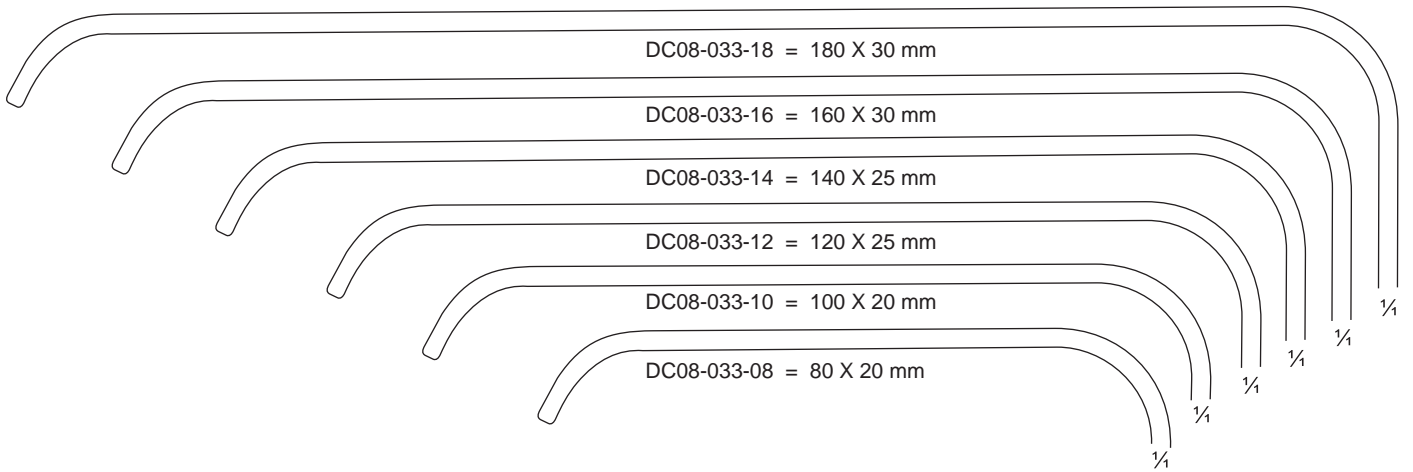

ACMA
INTERNATIONAL

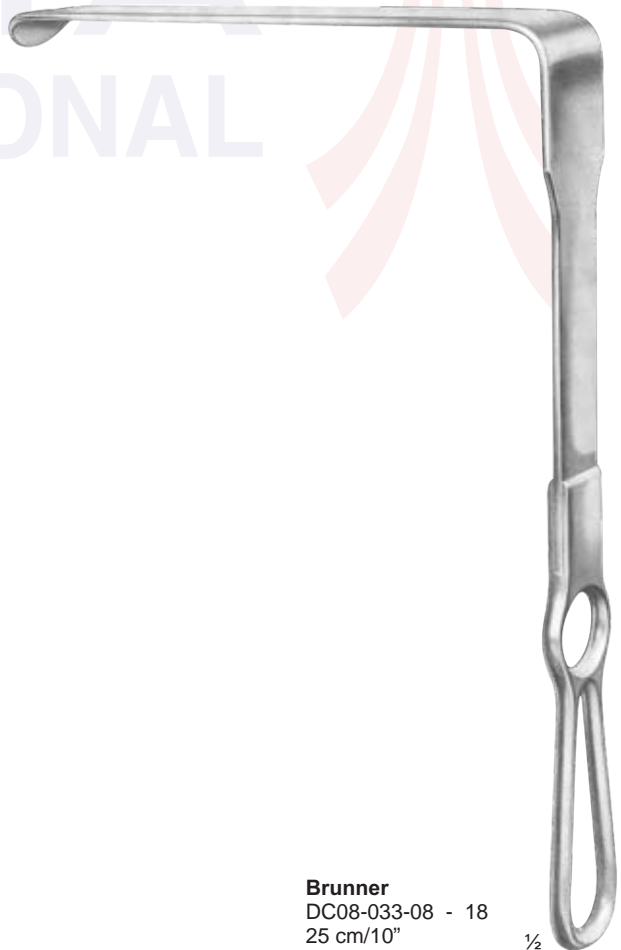

Brunner
DC08-033-08 - 18
25 cm/10"

1/2

Abdominal and Vaginal Retractors

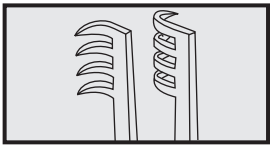

115 x 27mm
115 x 22mm

105 x 27mm

95 x 20mm



Simon
DC08-239-22 = 115 x 22mm
DC08-239-27 = 115 x 27mm
28cm/11"

Martin
DC08-237-27
105 x 27mm
26cm/10 1/4"

Modell Tübingen
DC08-235-95
95 x 20mm
28cm/11"



DC08-241-18 180 x 30mm

DC08-241-16 160 x 30mm

DC08-241-14 140 x 30mm

DC08-241-13 130 x 30mm

DC08-241-12 120 x 25mm

DC08-241-10 100 x 25mm

DC08-241-08 80 x 20mm



1/2

Brunner
25cm/10"

ACMA
INTERNATIONAL

1/4

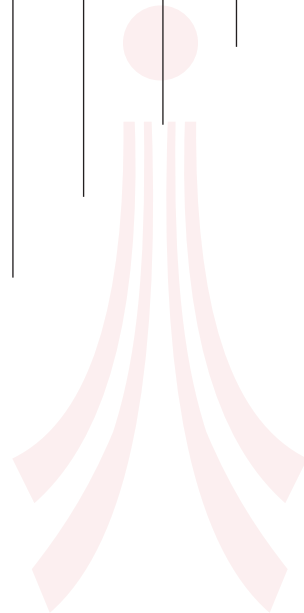

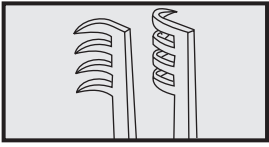

Retractors



$\frac{1}{2}$
Hösel
25cm/10"



DC08-243-62
60 x 20 mm

$\frac{1}{4}$



DC08-243-83
80 x 30 mm

$\frac{1}{4}$

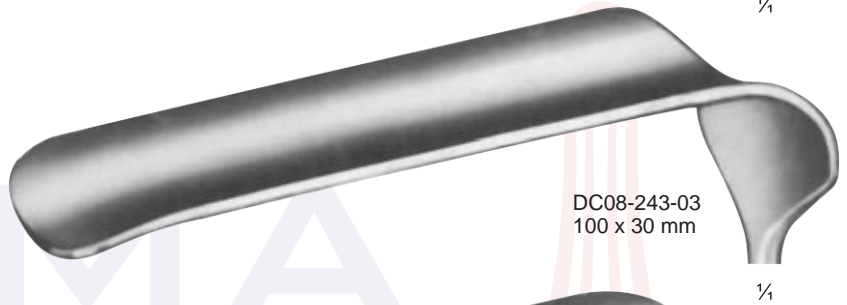

DC08-243-03
100 x 30 mm

$\frac{1}{4}$

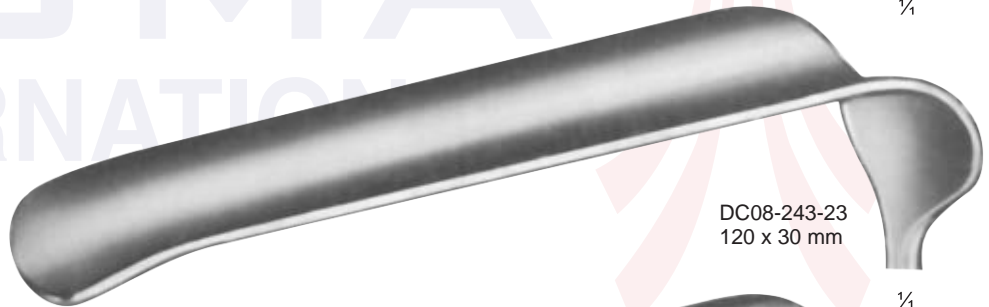

DC08-243-23
120 x 30 mm

$\frac{1}{4}$



DC08-243-43
140 x 30 mm

$\frac{1}{4}$



DC08-243-44
140 x 40 mm

$\frac{1}{4}$

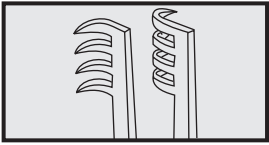

Retractors, Lung Spatulas



Deaver
DC08-245-07
30 cm/12"



Deaver
DC08-245-08
30 cm/12"



Deaver
DC08-245-09
30 cm/12"

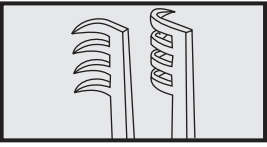

1/2
Deaver
DC08-247-01
18 cm/7"

1/2
Deaver
DC08-247-02
21.5 cm/8 1/2"

1/2
Deaver
DC08-247-03
23 cm/9"

1/2
Deaver
DC08-247-04
30 cm/12"

1/2
Deaver
DC08-247-05
33 cm/13"

1/2
Deaver
DC08-247-06
36 cm/14"

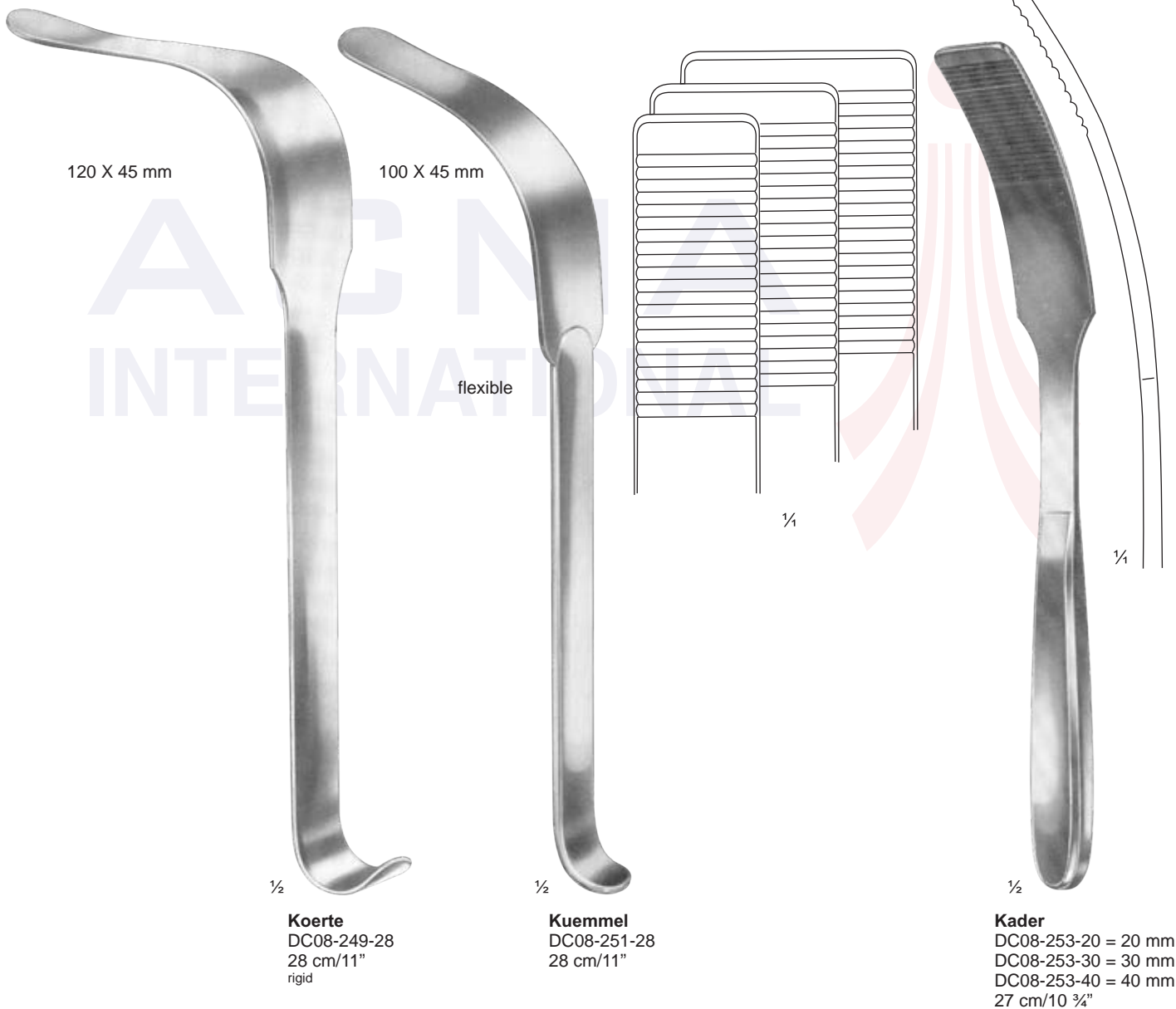
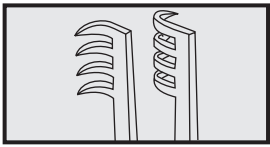

120 X 45 mm

100 X 45 mm

flexible

1/2

1/2

1/4

1/4

Koerte
DC08-249-28
28 cm/11"
rigid

Kuemmel
DC08-251-28
28 cm/11"

Kader
DC08-253-20 = 20 mm
DC08-253-30 = 30 mm
DC08-253-40 = 40 mm
27 cm/10 3/4"

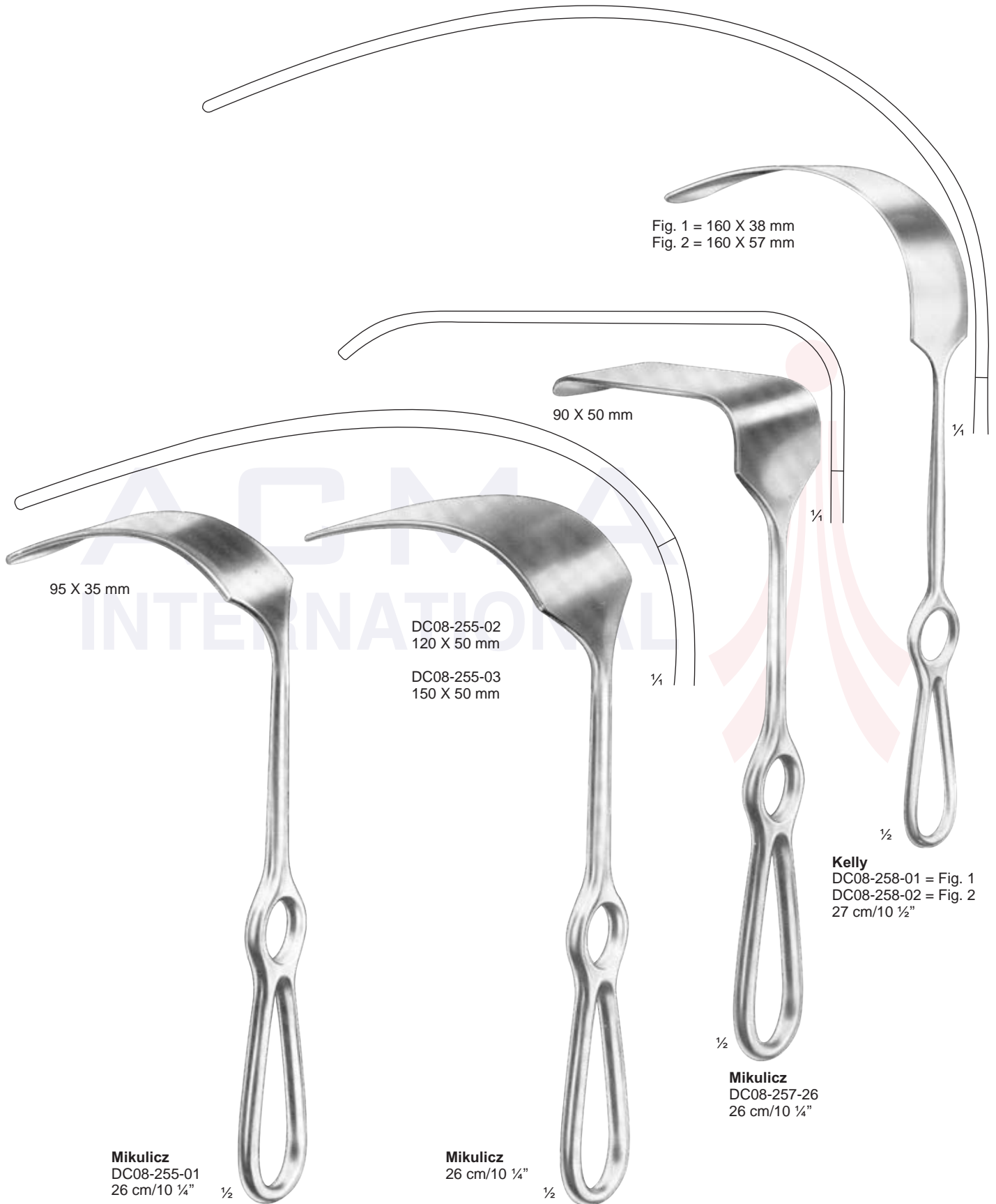
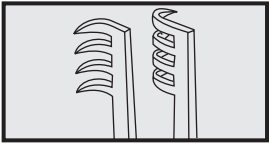

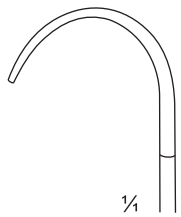

¼

14 X 17 mm



½

DC08-259-01
DC08-261-01
21.5 cm/8 ½"

20 X 22 mm



½

DC08-259-02
DC08-261-02
22 cm/8 ¾"

26 X 30 mm



½

DC08-259-03
DC08-261-03
23.5 cm/9 ¼"



Middeldorpf
DC08-259-01-
DC08-261-03

49 X 38 mm
28 X 20 mm

Fig. 1 ▶



36 X 28 mm
63 X 49 mm

Richardson-Eastman
DC08-263-00 = Set 1 + 2
DC08-263-01 = Fig. 1 = 26 cm/10 ¼"
DC08-263-02 = Fig. 2 = 28 cm/11"

◀ Fig. 2



½

Richardson
24 cm/9 ½"



28 X 20 mm

DC08-265-01



36 X 28 mm

DC08-265-02



44 X 38 mm

DC08-265-03

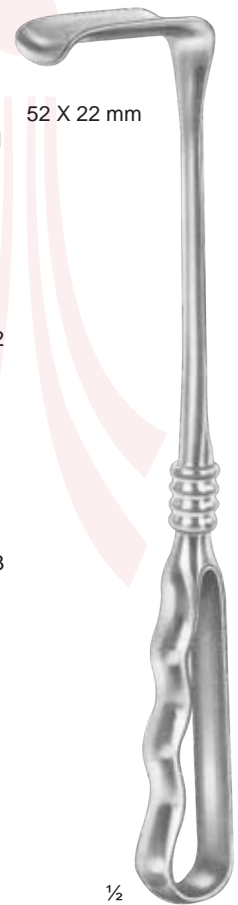

½

Richardson
DC08-267-24
24 cm/9 ½"

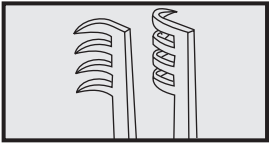

65 X 50 mm

1/2

Kelly
DC08-269-26
26 cm/10 1/4"



15-345-21 = 60 X 20 mm

1/4



1/2

DC08-271-01 = 35 X 7 mm

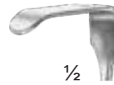

1/2

DC08-271-02 = 35 X 10 mm



1/2

DC08-271-03 = 35 X 15 mm

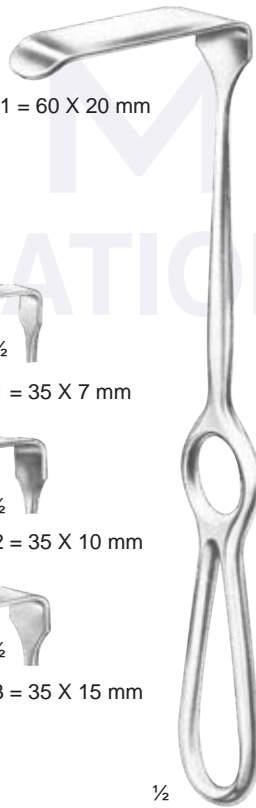

1/2

Langenbeck
21 cm/8 1/4"

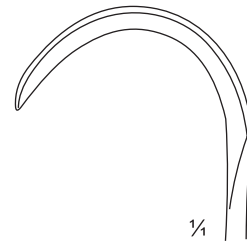

1/4



1/2

Kocher
DC08-273-01 = 40 X 10 mm
DC08-273-02 = 40 X 15 mm
DC08-273-03 = 40 X 20 mm
22 cm/8 3/4"



Middeldorpf
DC08-275-01-
DC08-275-03



Zenker
DC08-277-35
25 cm/10"

Zenker
DC08-277-60
26 cm/10 1/2"

Zenker
DC08-277-75
27.5 cm/11"

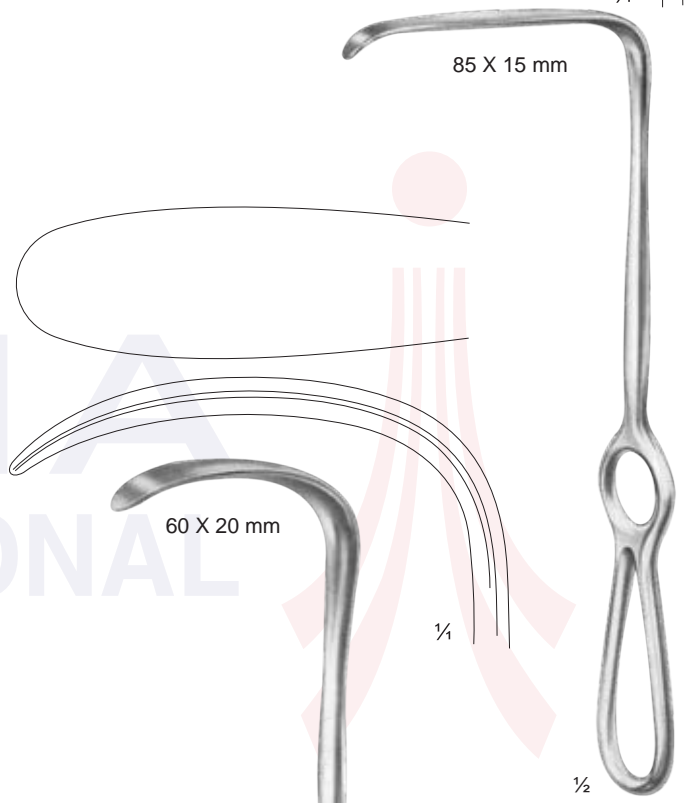
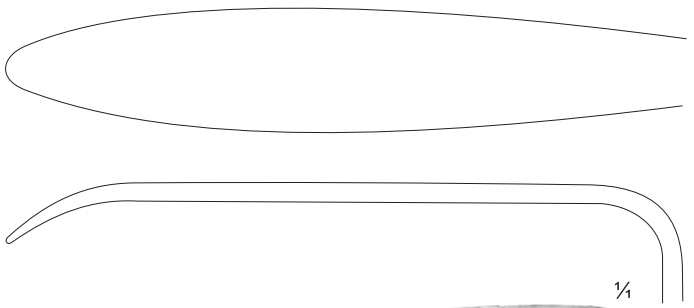
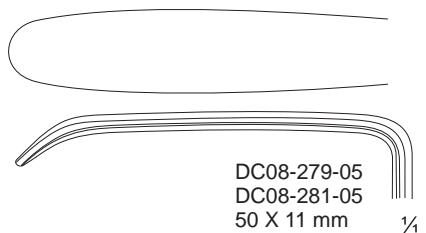
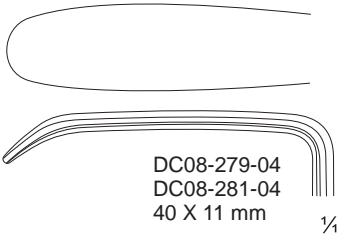
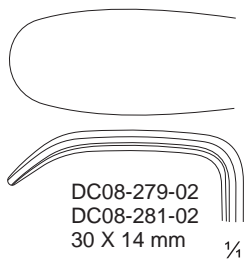
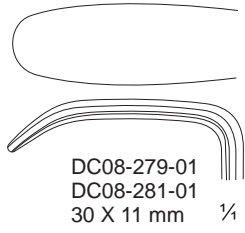
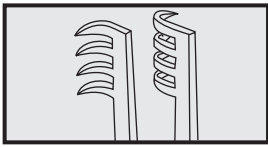

Langenbeck
DC08-279-01 - DC08-279-05
22 cm/8 1/2"



Langenbeck
DC08-281-01 - DC08-281-05
21 cm/8 1/4"



Langenbeck
DC08-283-21
21 cm/8 1/4"

Langenbeck
DC08-285-20
21 cm/8 1/2"

Retractors

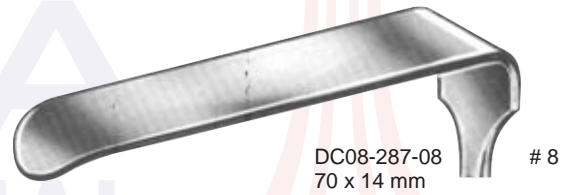
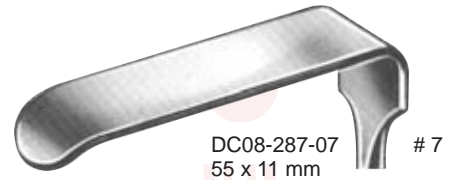
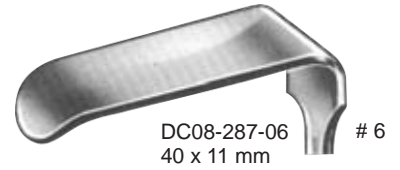
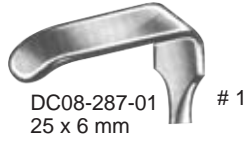
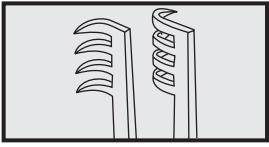

½
Kocher-Langenbeck
21.5cm/8 ½"

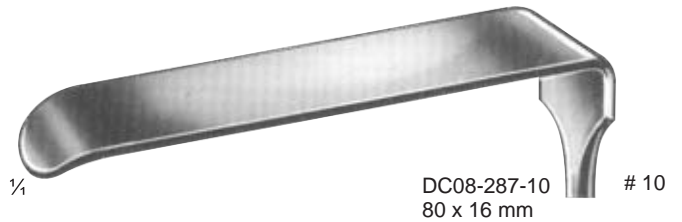
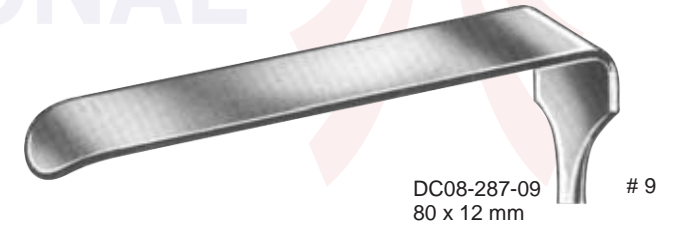

also available in special sizes

Retractors

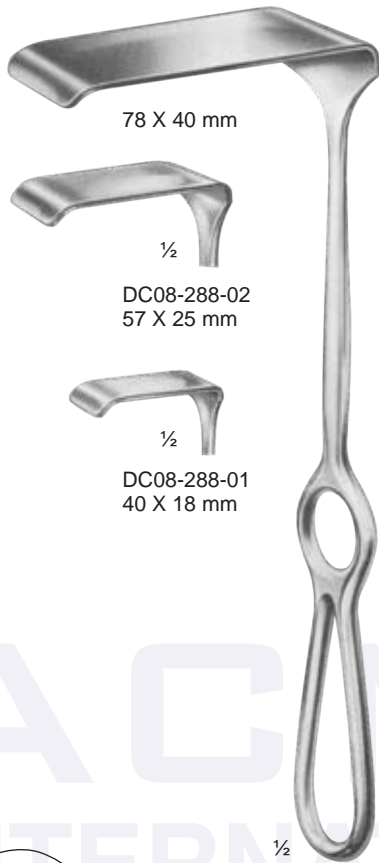
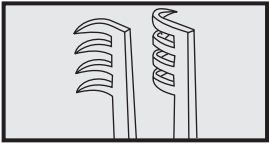

78 X 40 mm

1/2

DC08-288-02
57 X 25 mm

1/2

DC08-288-01
40 X 18 mm

1/2

DC08-288-03
23 cm/9 1/4"



DC08-289-01
40 X 12 mm 1/2

DC08-289-02
55 X 11 mm 1/2

1/2

Kocher
21 cm/8 1/4"

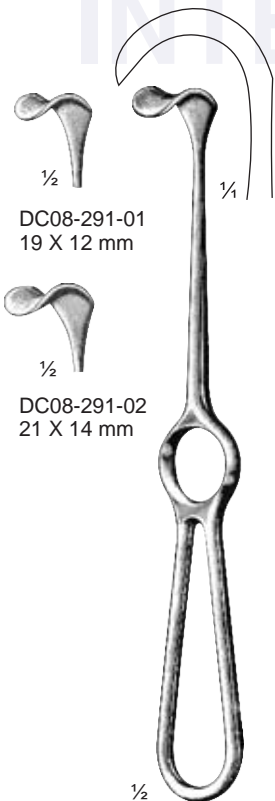

1/2

DC08-291-01
19 X 12 mm

1/2

DC08-291-02
21 X 14 mm

1/2

Kocher
19 cm/7 1/2"

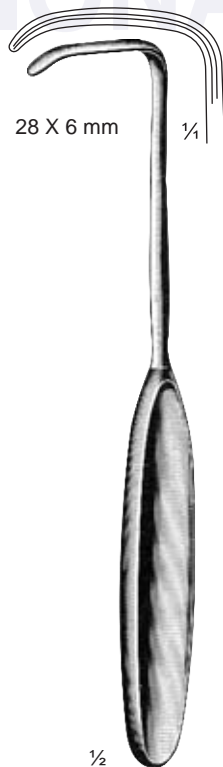

28 X 6 mm 1/4

1/2

Lahey
DC08-293-19
19 cm/7 1/2"



12 X 14 mm 1/4

1/2

Little
DC08-295-20
20 cm/8"

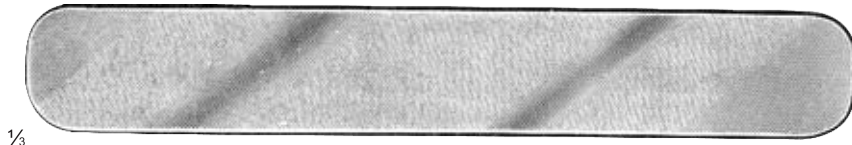
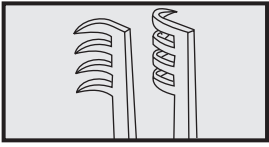

1/3

Flexible

DC08-297-01 = 33 cm/13" 30 mm
DC08-297-02 = 33 cm/13" 40 mm
DC08-297-03 = 33 cm/13" 50 mm



1/3

Haberer

DC08-299-00 = 20 cm/8" 17/25 mm
DC08-299-01 = 28 cm/11" 25/30 mm
DC08-299-02 = 30 cm/12" 37/45 mm



1/3

DC08-301-12 = 200 X 12mm
DC08-301-17 = 200 X 17mm
DC08-301-25 = 250 X 25mm

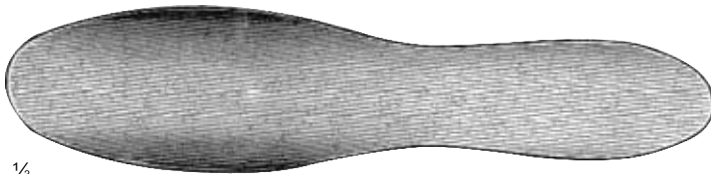

1/3

Reverdin

DC08-303-29
29 cm/11 1/2"

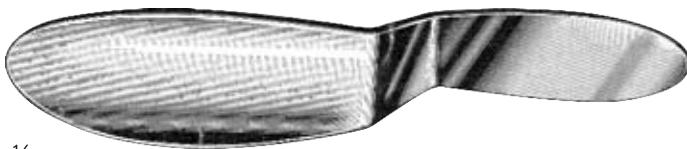

1/3

Reverdin

DC08-305-28
28 cm/11"



1/3

DC08-307-28
28 cm/11"
scoop 50X 45 mm

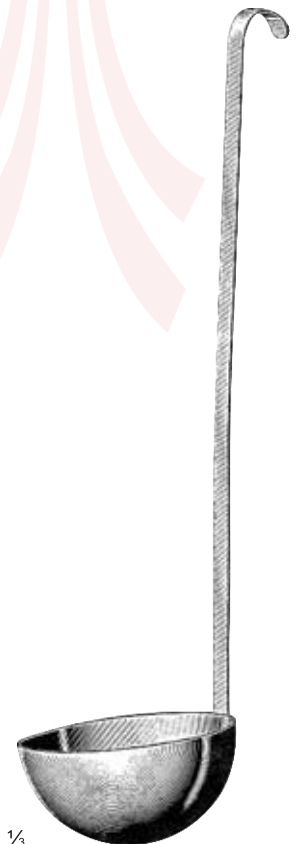

1/3

DC08-309-33
33 cm/13"
85 mm ø
100 ccm

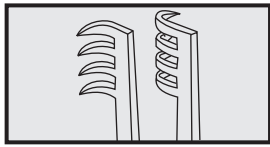

Fine Wound and Skin Retractors

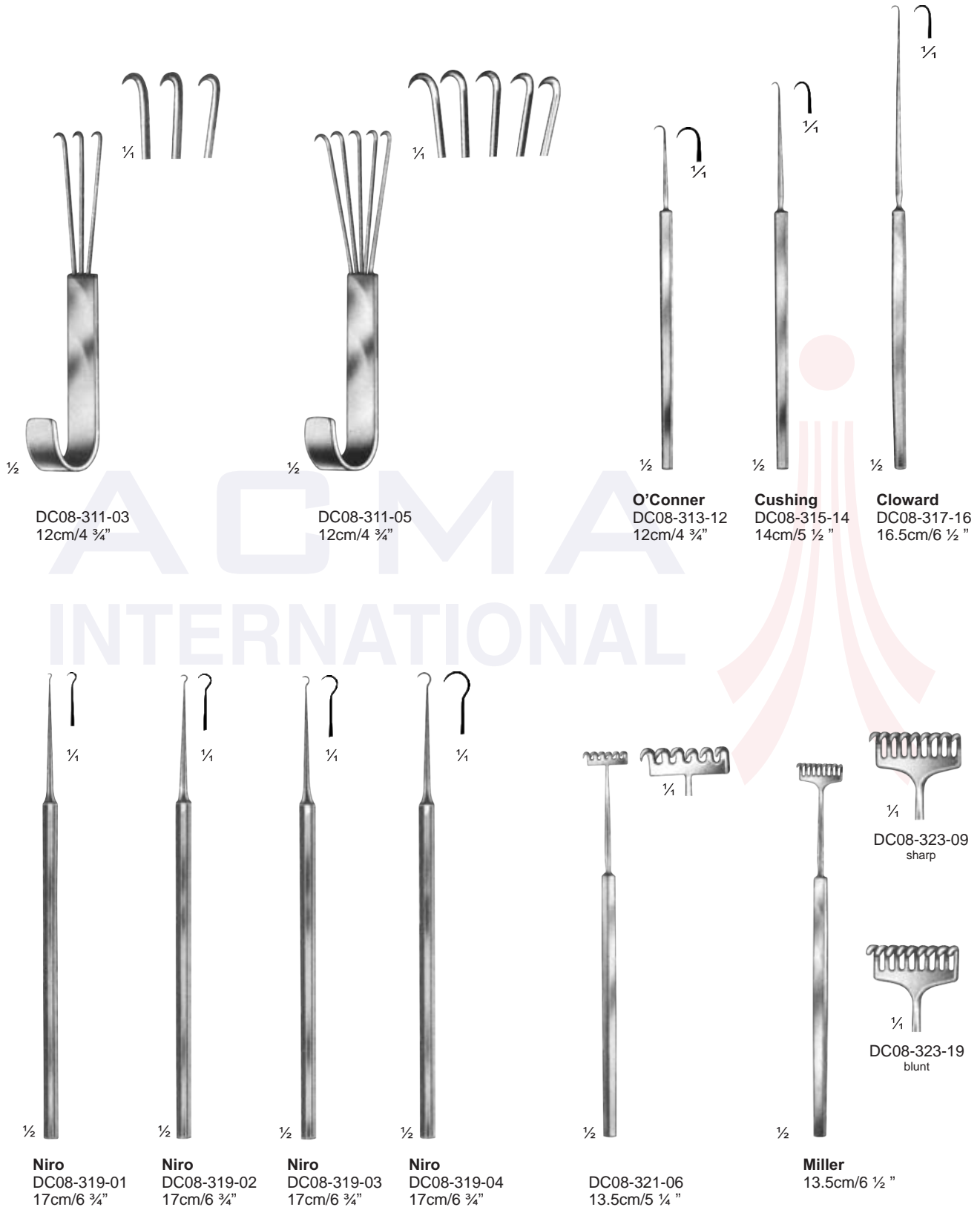

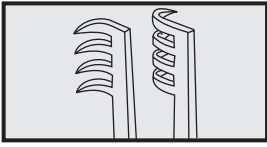

Fine Wound and Nerve Hooks

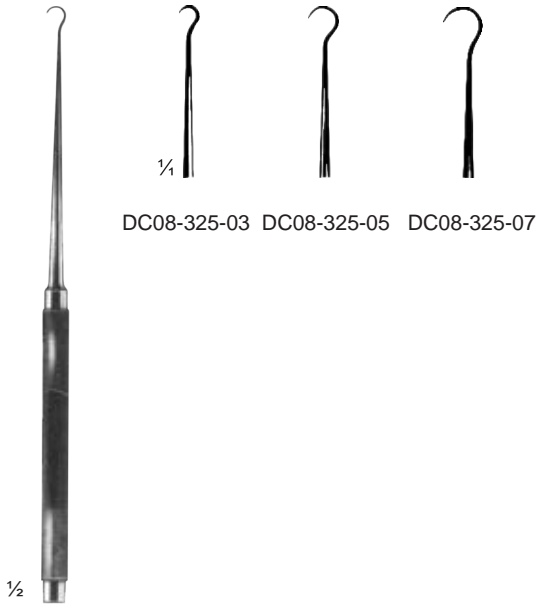

DC08-325-03 DC08-325-05 DC08-325-07

Kleinert-Kutz
16cm/6 1/4"

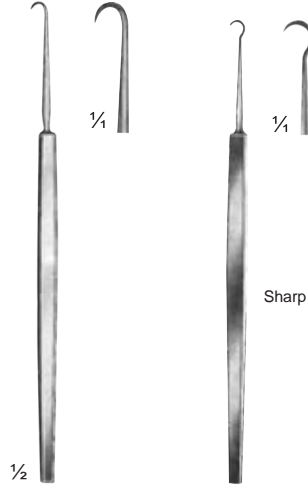

Cushing
DC08-327-14
14.5cm/5 3/4"

Frazier
DC08-329-13
13cm/5"

DC08-329-18
18cm/7"

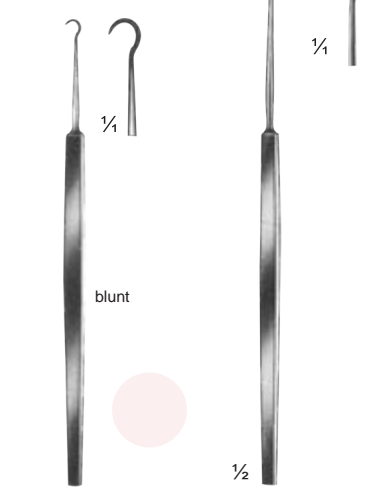

Frazier
DC08-331-13
13cm/5"

DC08-331-18
18cm/7"

Tonnis
DC08-333-15
15cm/6"

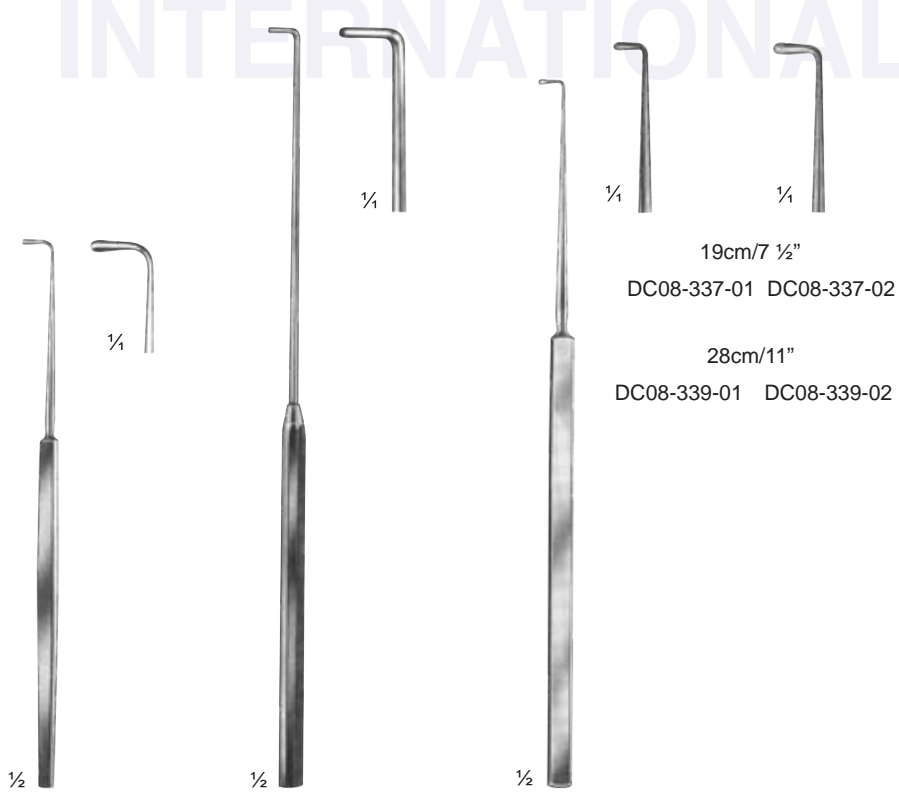

Crile
DC08-335-14
14.5cm/5 3/4"

Crile
DC08-335-20
20cm/8"

Cushing

19cm/7 1/2"
DC08-337-01 DC08-337-02

28cm/11"
DC08-339-01 DC08-339-02

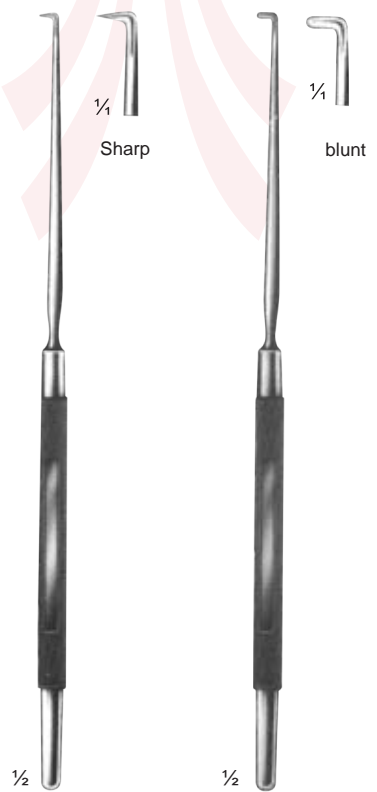

Adson
DC08-341-20
20cm/8"

Adson
DC08-343-20
20cm/8"

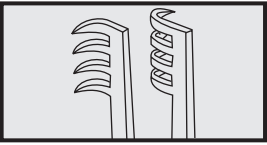

Wound and Trachea Retractors, Mucous Hooks



Jackson
BC08-345-13
13cm/5"



Jackson
BC08-345-15
15cm/6"



News
BC08-347-15
15cm/6"



Cottle
BC08-349-16
16cm/6 1/4"

ACMA
INTERNATIONAL



Freer
BC08-351-15
15cm/6"



Iterson
BC08-353-16
16cm/6 1/4"



Iterson
BC08-355-16
16cm/6 1/4"

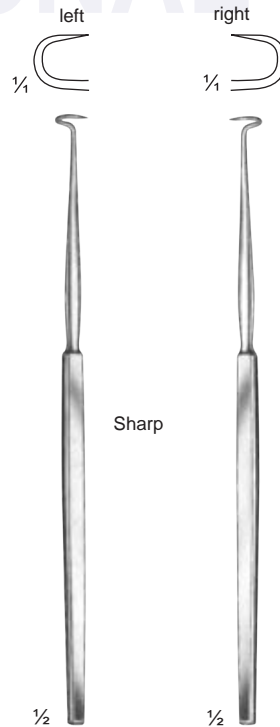

Bose
BC08-357-01
16cm/6 1/4"



Bose
BC08-357-02
16cm/6 1/4"



Bose
BC08-357-11
16cm/6 1/4"



Bose
BC08-357-12
16cm/6 1/4"

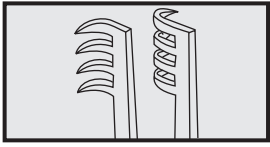

Wound and Trachea Retractors, Ear Hooklets



Kilner (Barsky)
DC08-359-15
15cm/6"



Hartmann
DC08-361-16
16cm/6 1/2"



Gillies
DC08-363-01
18cm/7"



Gillies
DC08-363-02
18cm/7"



Gillies
DC08-363-52
18cm/7"



Sachs
DC08-365-21
21cm/8 1/4"



Schoenborn
DC08-367-21
21cm/8 1/4"

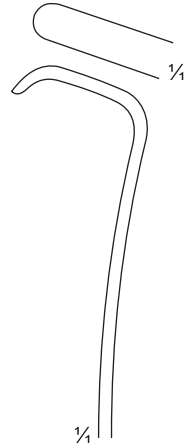

Lukens
DC08-369-17
17cm/6 3/4"



Jackson
DC08-371-17
17cm/6 3/4"



Cope
DC08-373-18
18cm/7"

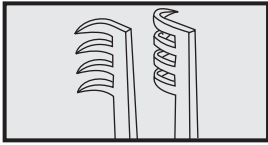

Fine Wound and Nerve Hooks, Ear Hooklets

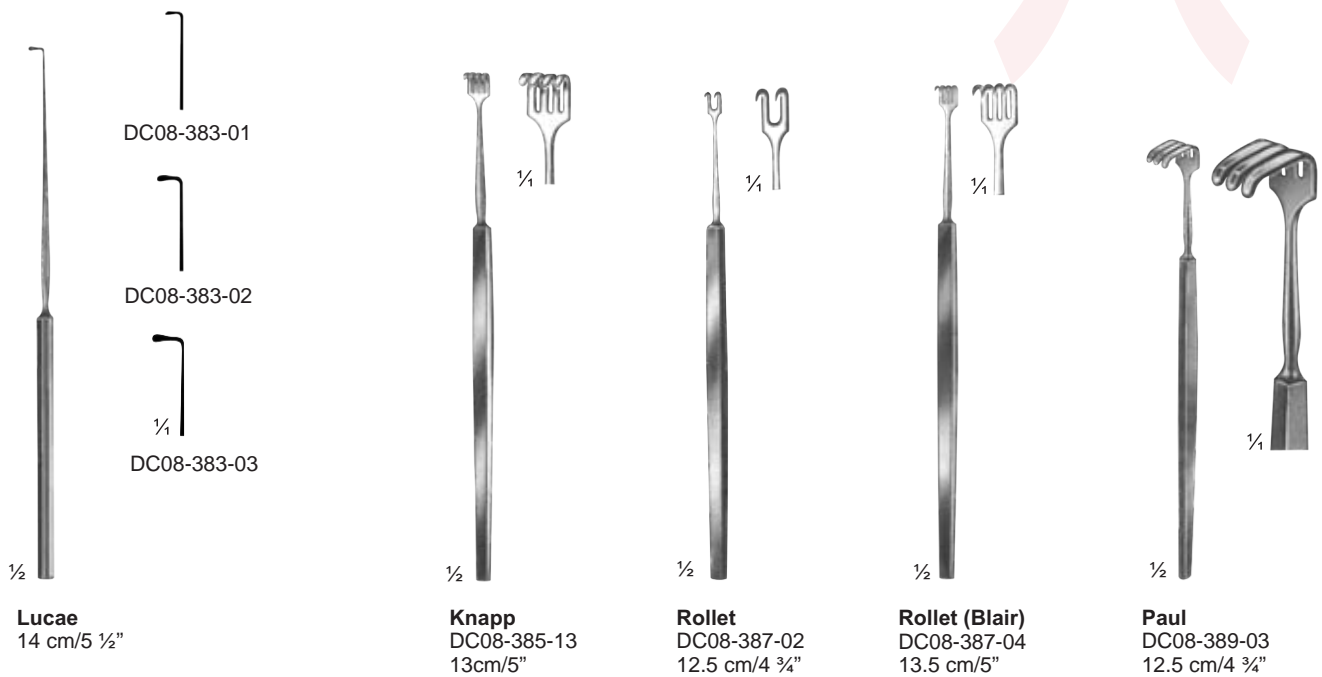
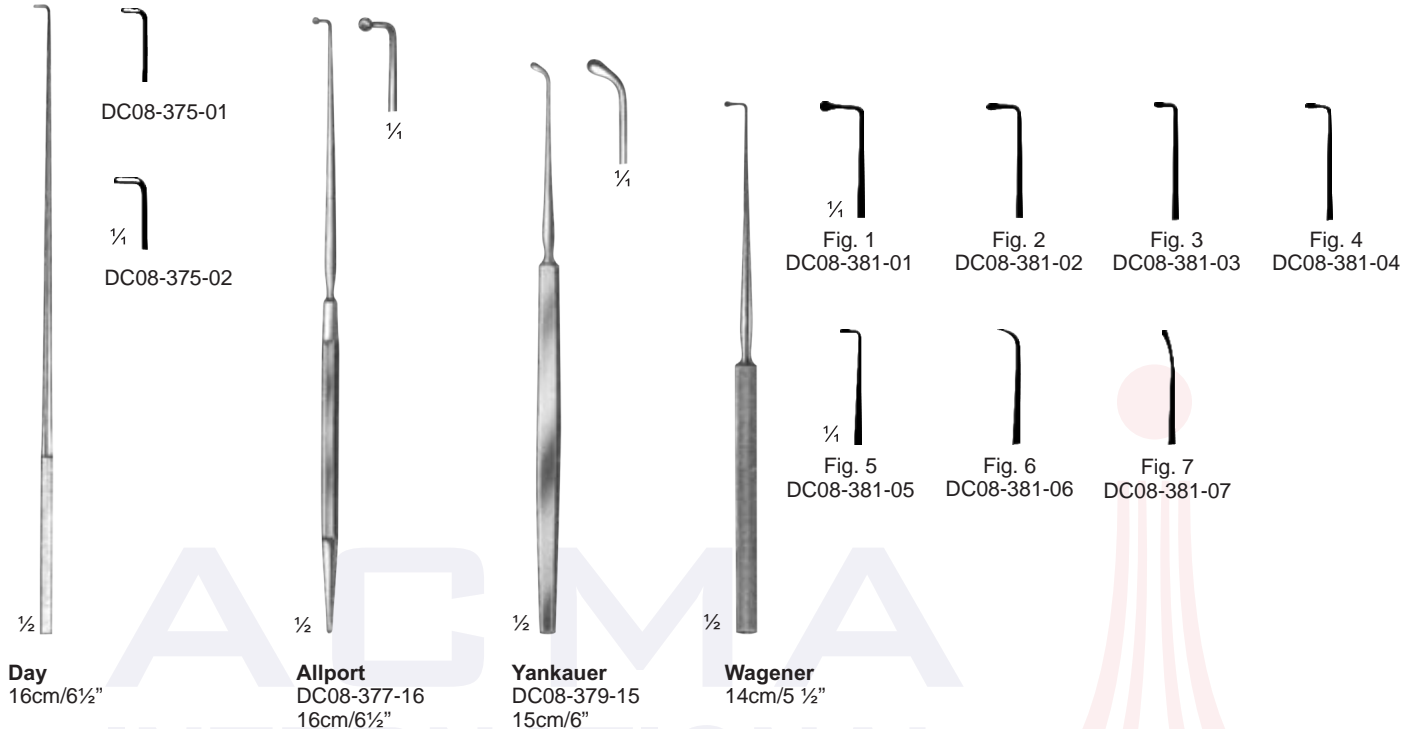

Fistula-and fine Skin Hooks

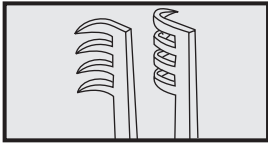

Bergmann
DC08-391-07
14cm/5 1/2"



7mm

1/4



Graefe (Tyrell)
12cm/4 3/4"

Iris Hooks



1/4

DC08-393-12
sharp



1/4

DC08-395-12
blunt

Fixation Hooks, double



1/4

1/2

Guthrie
DC08-397-01
12cm/4 3/4"



1/4

1/2

Guthrie
DC08-399-02
13cm/5"



Emmet
22cm/8 3/4"



1/4

DC08-401-01



DC08-401-02



DC08-401-03



1/4

DC08-401-04



DC08-401-05



Simon
DC08-403-01
22cm/8 3/4"

1/4

1/2



Simon
DC08-403-02
22cm/8 3/4"

1/4

1/2

ACMA INTERNATIONAL

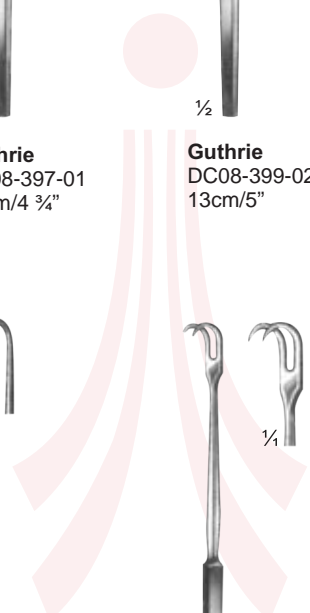

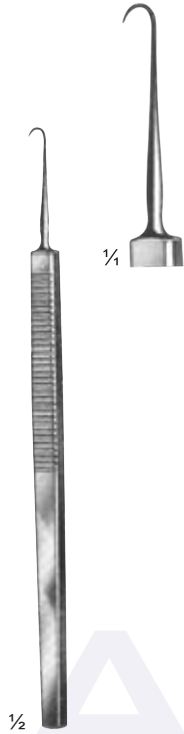
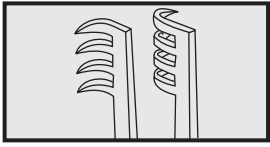

O'Connor
DC08-405-16
16cm/6 1/4"



1/4



Guthrie
16cm/6 1/4"



1/4

DC08-407-01



DC08-407-02



Graefe
16 cm/6 1/4"



1/4

DC08-409-01
sharp



DC08-409-11
blunt



1/2
16cm/6 1/4"



DC08-411-01



DC08-411-02



1/4
DC08-411-03



DC08-411-04



1/2
DC08-413-14
14cm/5 1/2"



1/4



1/2
Cushing
14.5 cm/5 1/2"



DC08-415-01



DC08-415-02



1/4
DC08-415-03



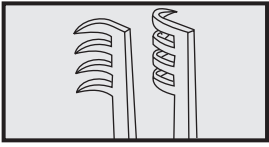

Volkmann
23 cm/9"

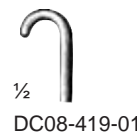
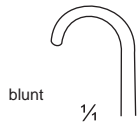
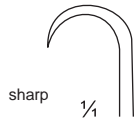

1/2
16 cm/6 1/4"



Cushing
20 cm/8"

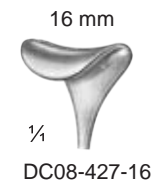
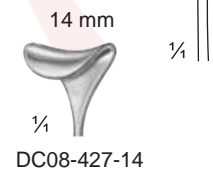
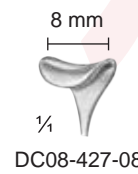
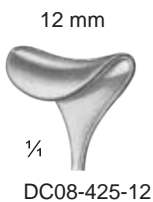
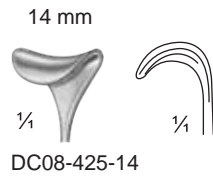
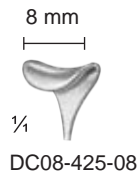

1/2
Cushing
24 cm/9 1/2"

Retractor

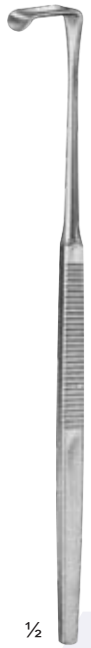
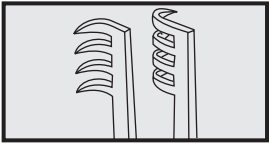

Mini-Langenbeck
16 cm/6 1/4"

10 x 6 mm



DC08-429-10

20 x 6 mm



DC08-429-20

17 x 5 mm



DC08-429-17

22 x 8 mm



DC08-429-22

14 x 8 mm

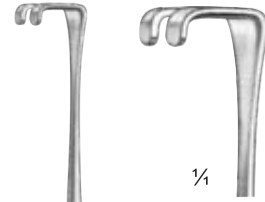

DC08-431-16
16 cm/6 1/4"

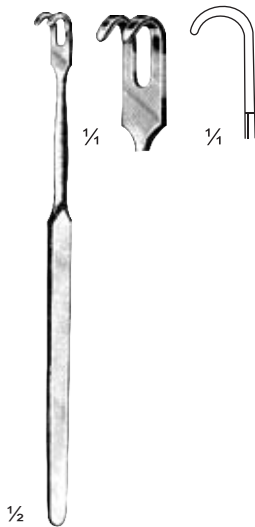

DC08-433-02
13.5 cm/5 1/4"

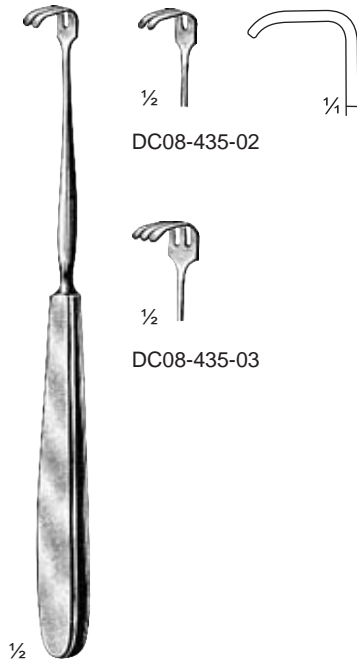

Klapp
17.5 cm/7"

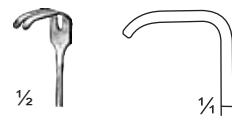

DC08-435-02



DC08-435-03



Strandell-Stille
19 cm/7 1/2"

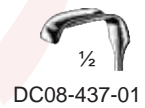

DC08-437-01

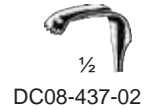

DC08-437-02

toothed

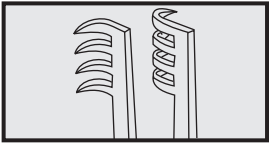

Retractor

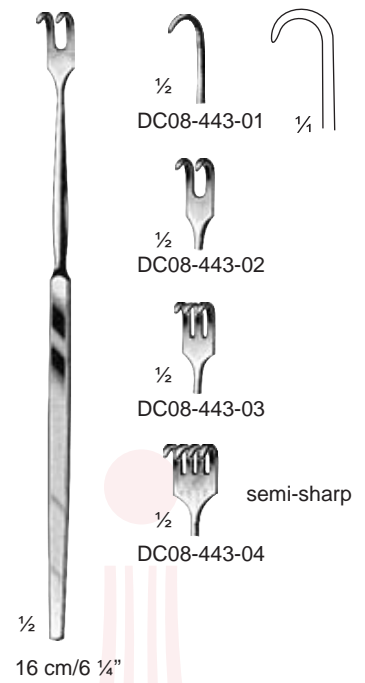
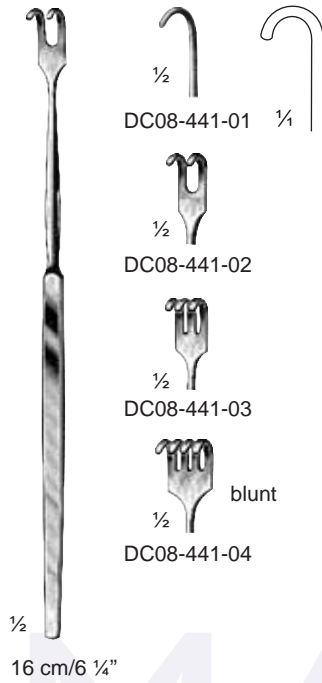
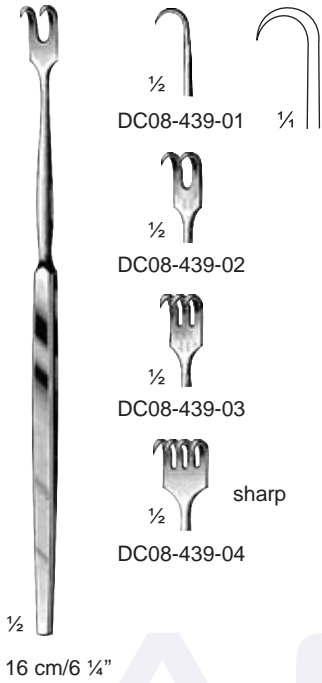

ACMA
INTERNATIONAL

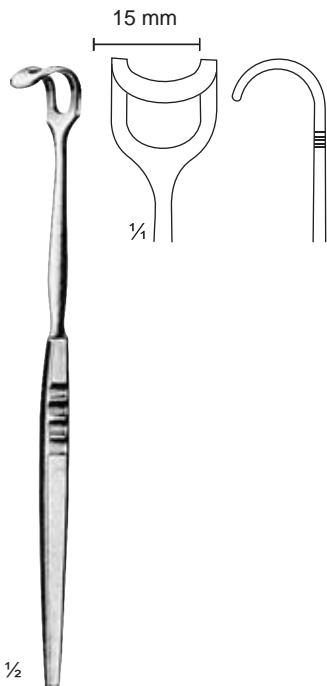

Handte
DC08-445-17
17 cm/6 $\frac{3}{4}$ "

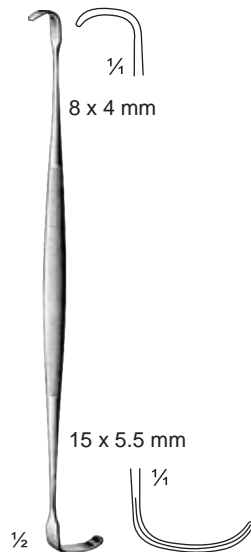

Ragnell-Davis
DC08-447-14
14 cm/5 $\frac{1}{2}$ "

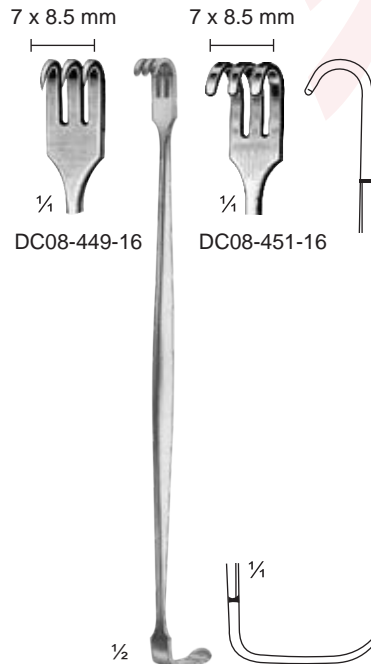

Senn-Mueller
16 cm/6 $\frac{1}{4}$ "



Cushing
DC08-453-20
20 cm/8"

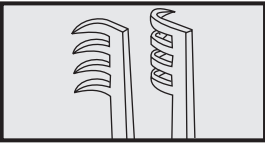

Micro retractor with saddle blade, buttoned

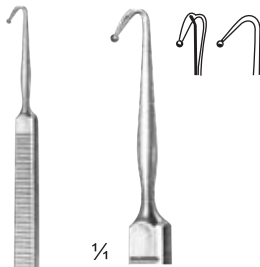

DC08-455-12
12 cm/4 1/2"

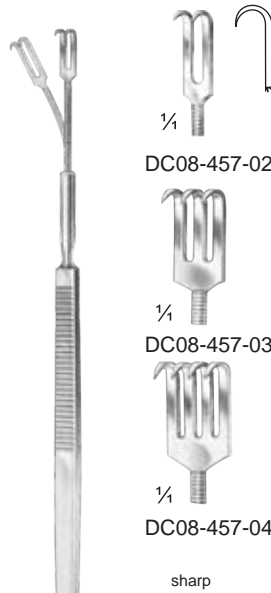

DC08-457-02
DC08-457-03
DC08-457-04
sharp flexible blunt
16 cm/6 1/4"



DC08-459-02
DC08-459-03
DC08-459-04
sharp flexible blunt
16 cm/6 1/4"

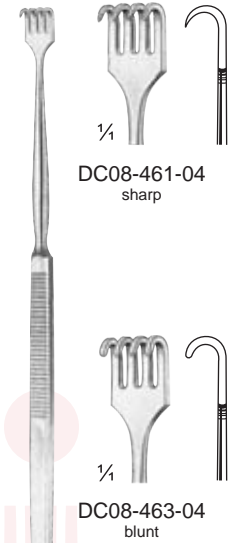

DC08-461-04 sharp
DC08-463-04 blunt
16 cm/6 1/4"

ACMA INTERNATIONAL

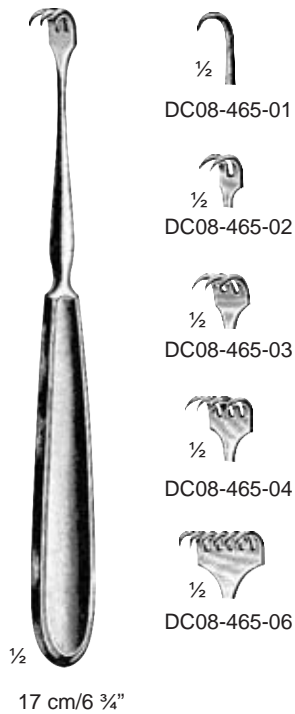

DC08-465-01
DC08-465-02
DC08-465-03
DC08-465-04
DC08-465-06
1/2
17 cm/6 3/4"

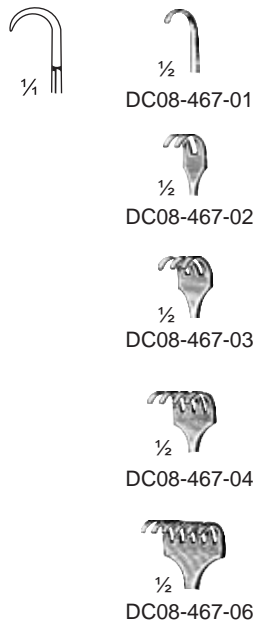

DC08-467-01
DC08-467-02
DC08-467-03
DC08-467-04
DC08-467-06
1/2

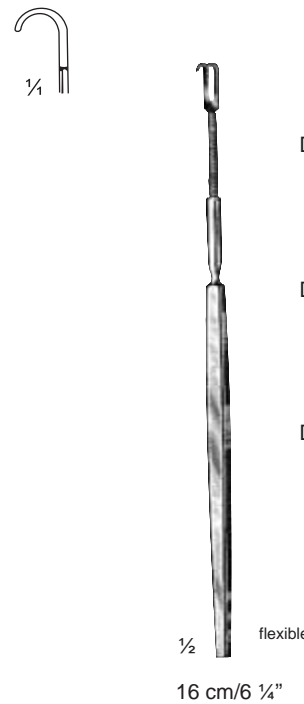

DC08-469-02
DC08-469-03
DC08-469-04
flexible
16 cm/6 1/4"

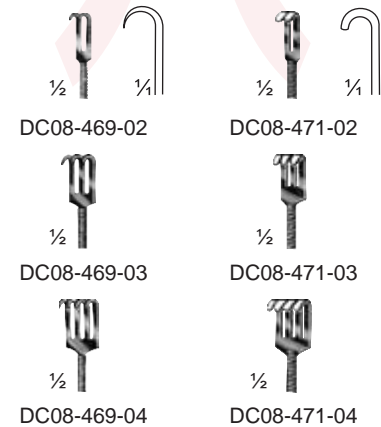

DC08-471-02
DC08-471-03
DC08-471-04
1/2

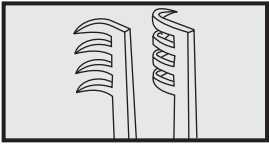

Retractor

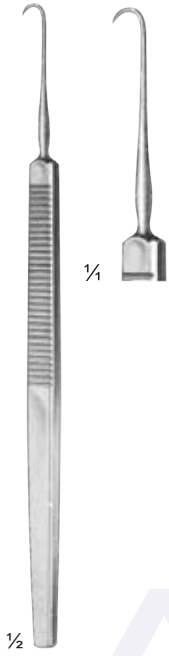

O'Connor
DC08-473-16
16 cm/6 1/4"



Graefe
16 cm/6 1/4"



DC08-475-01
sharp



DC08-475-02
blunt



1/4
DC08-477-01



1/4
DC08-477-02



1/4
DC08-477-03



1/4
DC08-477-04

ACMA INTERNATIONAL



DC08-479-16
16 cm/6 1/4"



Desmarres
16 cm/6 1/4"

8 mm



1/4
DC08-481-08

14 mm



1/4
DC08-481-14

10 mm



1/4
DC08-481-10

16 mm



1/4
DC08-481-16

12 mm



1/4
DC08-481-12

18 mm



1/4
DC08-481-18

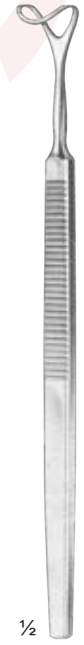

16 cm/6 1/4"

12 mm



1/4
DC08-483-12

14 mm



1/4
DC08-483-14

16 mm



1/4
DC08-483-16

18 mm



1/4
DC08-483-18

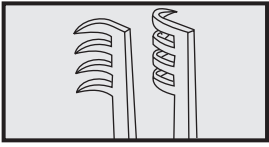

Retractor

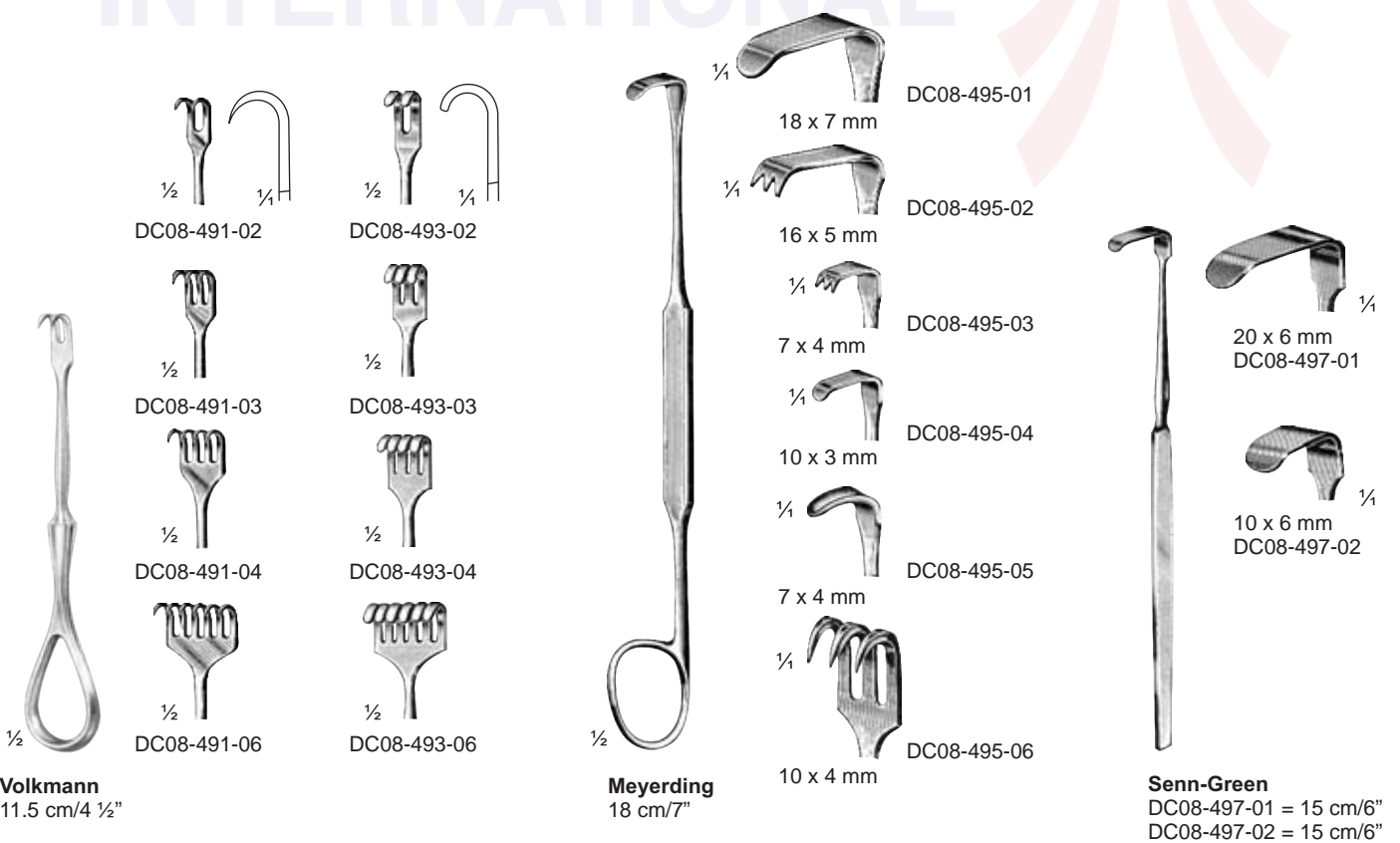

Retractor

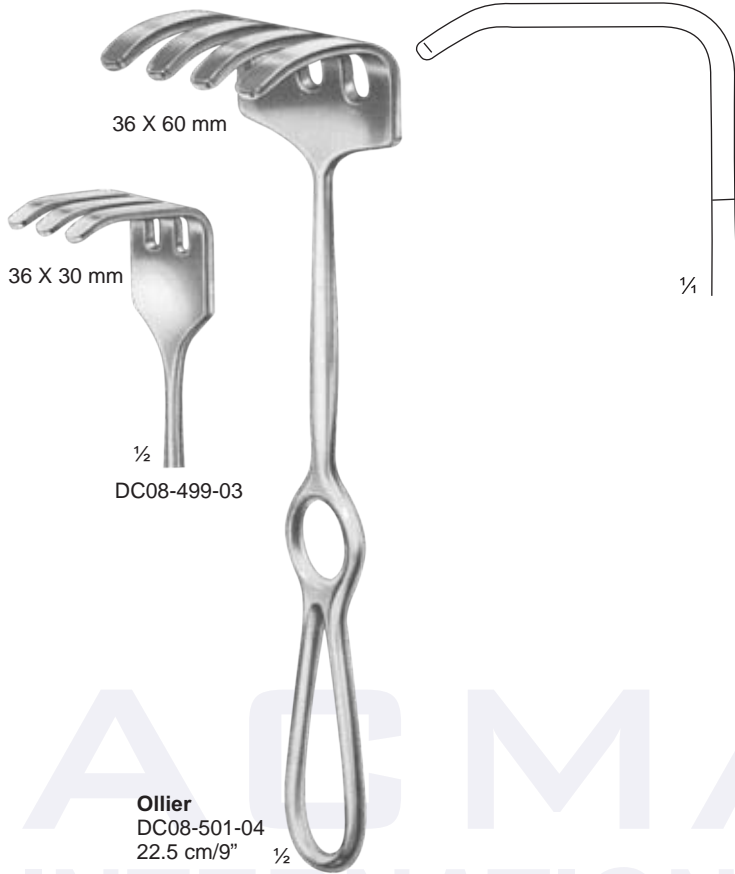
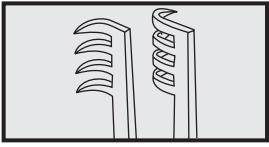

36 X 60 mm

36 X 30 mm

1/2

DC08-499-03

Ollier
DC08-501-04
22.5 cm/9"

1/2

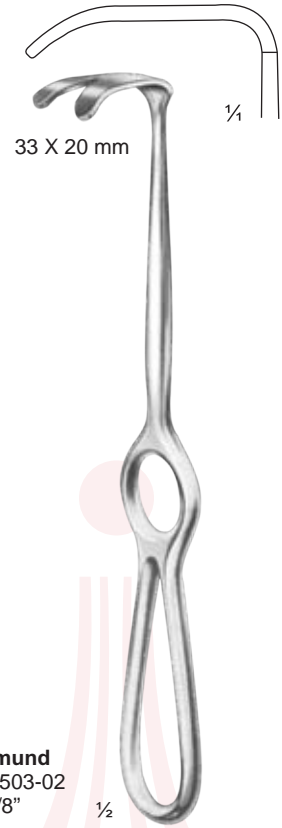

33 X 20 mm

1/4

1/2

Wassmund
DC08-503-02
20 cm/8"

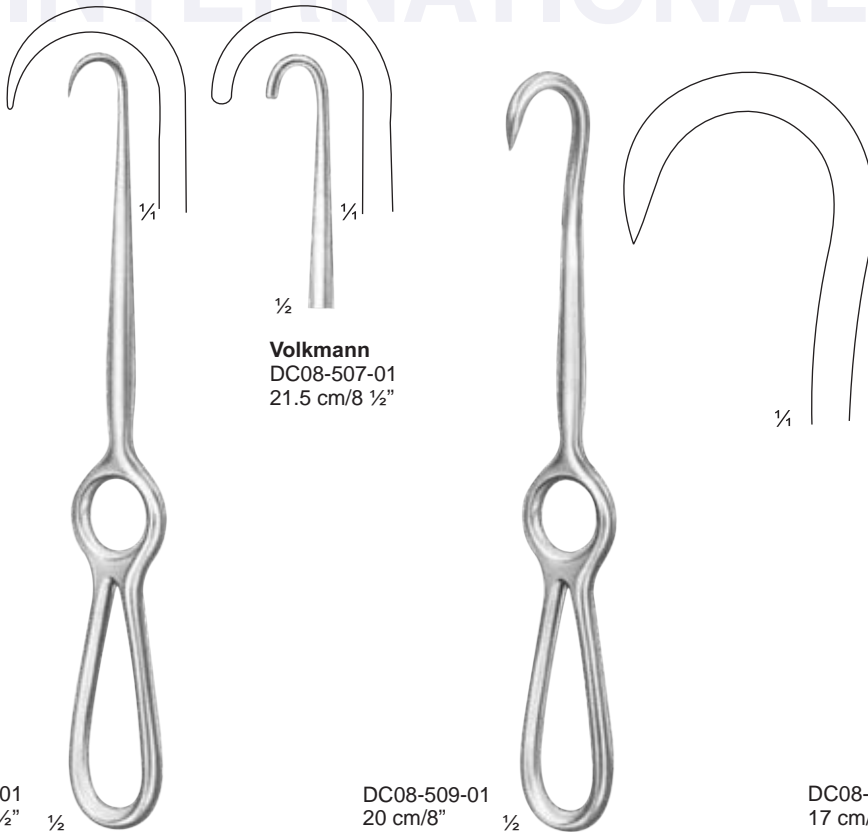

1/4

1/4

1/2

Volkman
DC08-507-01
21.5 cm/8 1/2"

1/4

1/4

Volkman
DC08-505-01
21.5 cm/8 1/2"

1/2

DC08-509-01
20 cm/8"

1/2

DC08-511-01
17 cm/6 3/4"

1/2

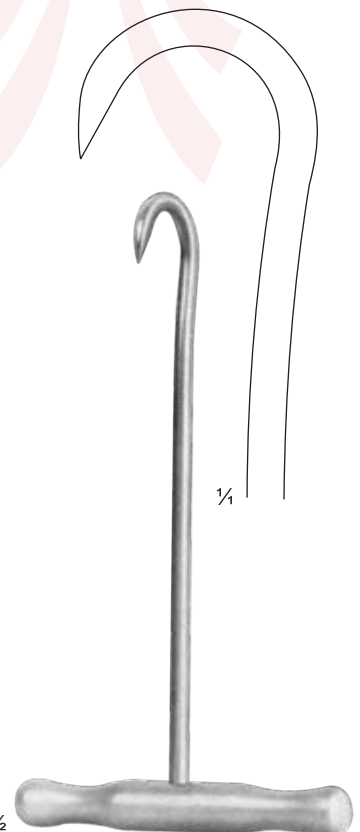

Retractor

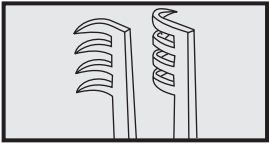

Volkmann
21.5 cm/8 1/2"



Kocher
22 cm/8 3/4"

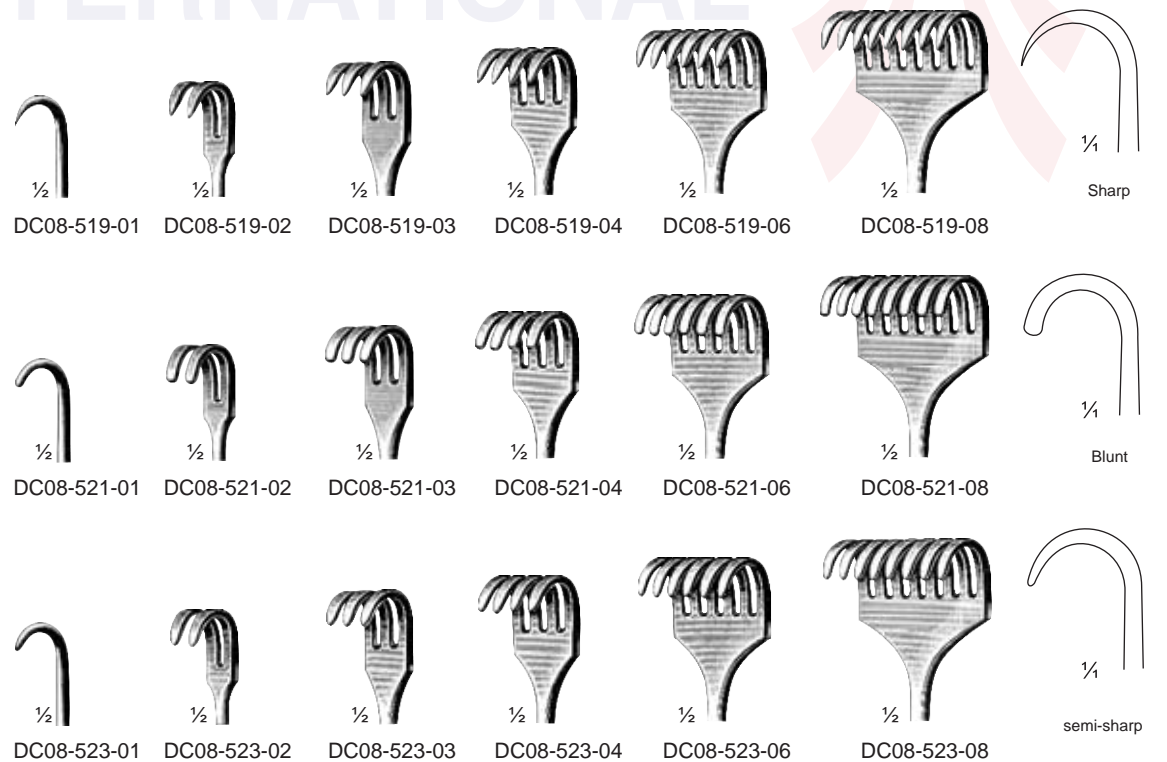

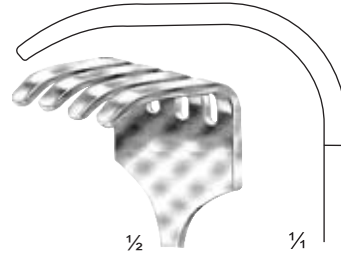
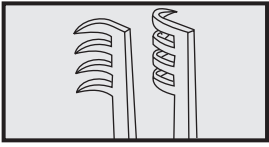

DC08-527-04
40 X 40 mm

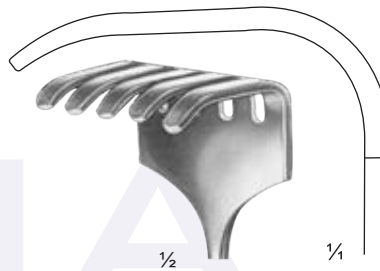

DC08-529-05
45 X 50 mm

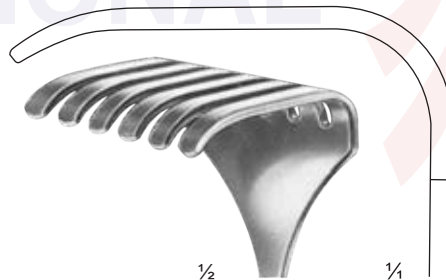

DC08-531-06
50 X 60 mm

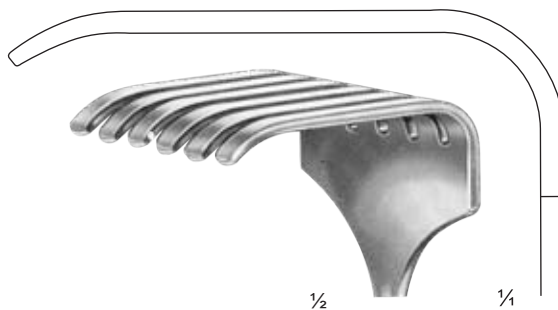

DC08-533-07
70 X 70 mm



DC08-525-07
27 cm/10 3/4"



Israel
25 cm/10"

