

3

Scissors

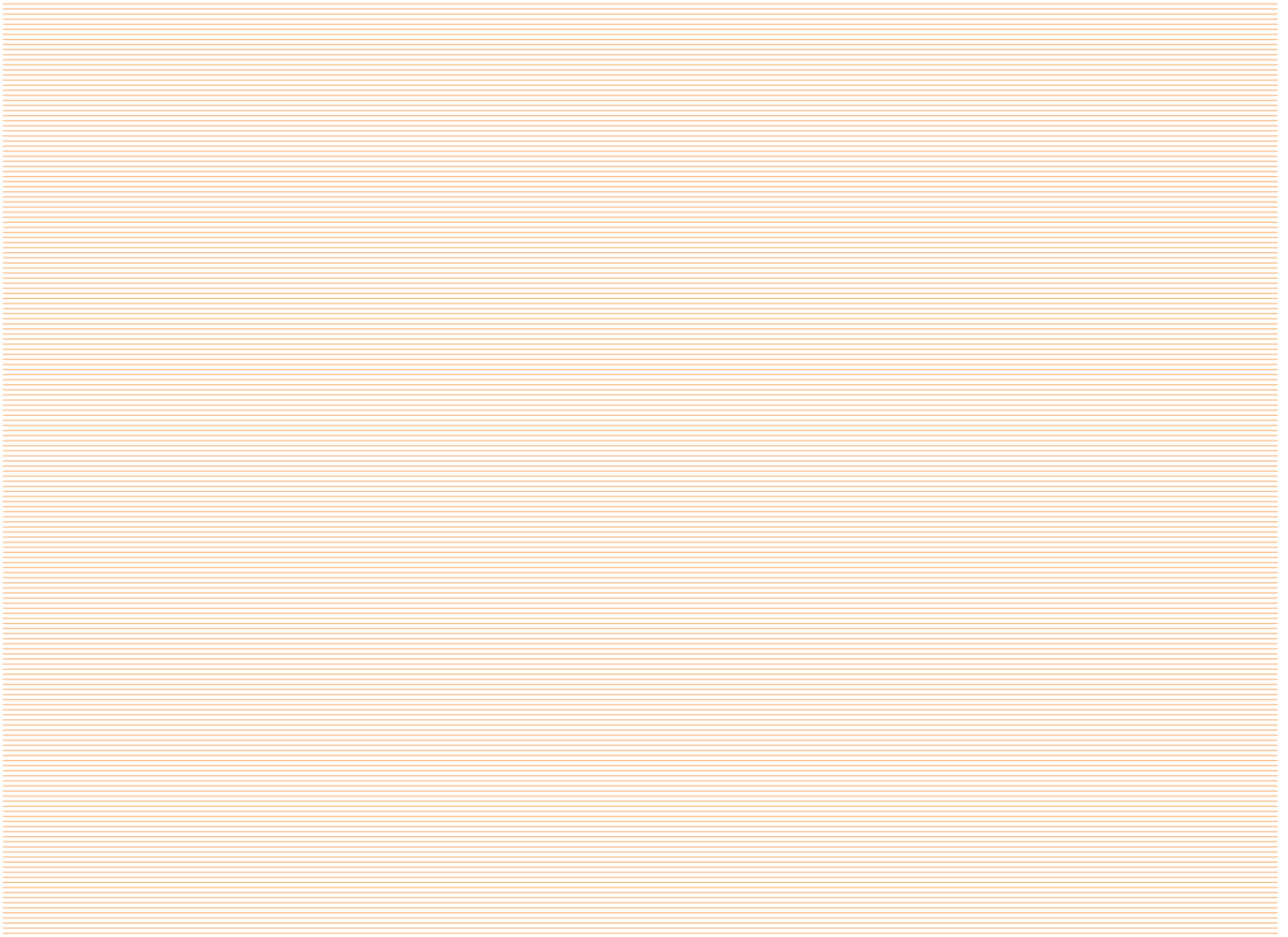

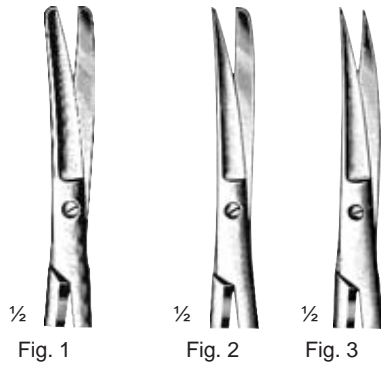
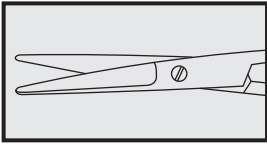

Standard
Fig. 1-3
curved

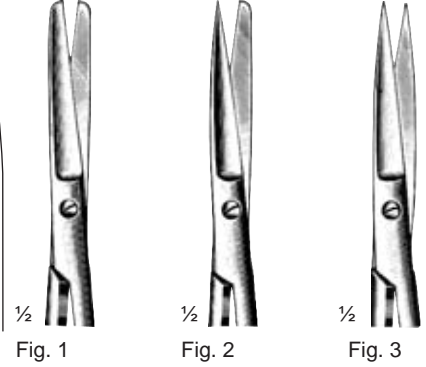
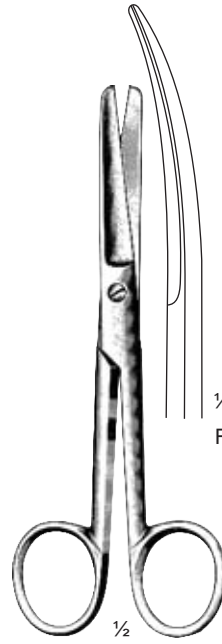

Standard
Fig. 1-3
straight

cm	in.	Fig. 1	Fig. 2	Fig. 3
11.5	4 ½	DC03-001-11	DC03-003-11	DC03-005-11
13.0	5	DC03-001-13	DC03-003-13	DC03-005-13
14.5	5 ½	DC03-001-14	DC03-003-14	DC03-005-14
15.5	6	DC03-001-15	DC03-003-15	DC03-005-15
16.5	6 ½	DC03-001-16	DC03-003-16	DC03-005-16
18.5	7 ¼	DC03-001-18	DC03-003-18	
20.0	8	DC03-001-20	DC03-003-20	

cm	in.	Fig. 1	Fig. 2	Fig. 3
10.5	4 ¼	DC03-007-10	DC03-009-10	DC03-011-10
11.5	4 ½	DC03-007-11	DC03-009-11	DC03-011-11
13.0	5	DC03-007-13	DC03-009-13	DC03-011-13
14.5	5 ½	DC03-007-14	DC03-009-14	DC03-011-14
15.5	6	DC03-007-15	DC03-009-15	DC03-011-15
16.5	6 ½	DC03-007-16	DC03-009-16	DC03-011-16
18.5	7 ¼	DC03-007-18	DC03-009-18	
20.0	8	DC03-007-20	DC03-009-20	

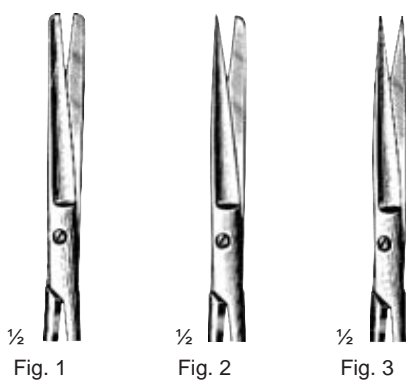

Graziil
Fig. 1-3
straight

cm	in.	Fig. 1	Fig. 2	Fig. 3
13.0	5		DC03-015-13	
14.5	5 ½	DC03-013-14	DC03-015-14	DC03-017-14

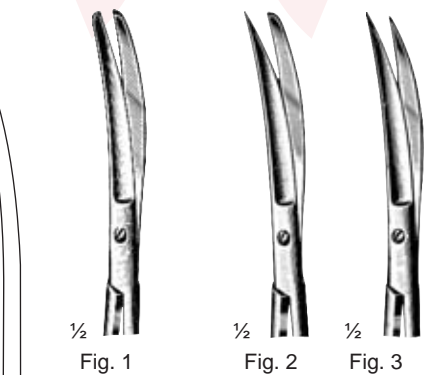
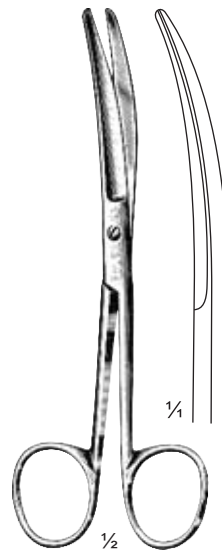

Graziil
Fig. 1-3
curved

cm	in.	Fig. 1	Fig. 2	Fig. 3
13.0	5		DC03-021-13	
14.5	5 ½	DC03-019-14	DC03-021-14	DC03-023-14

Operating & Preparation Scissors

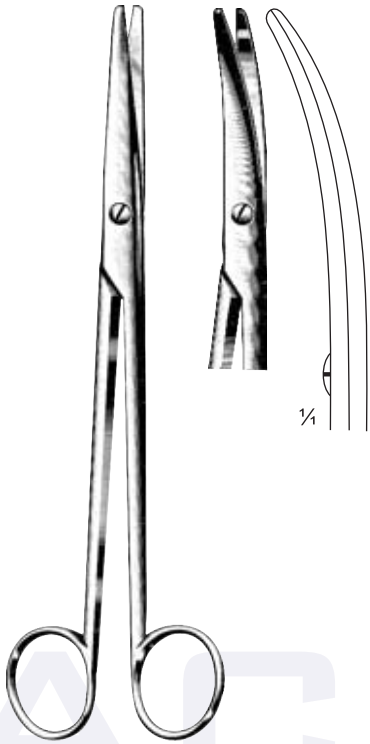
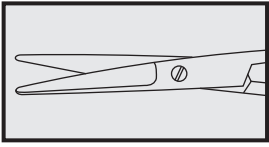

Mayo-Stille

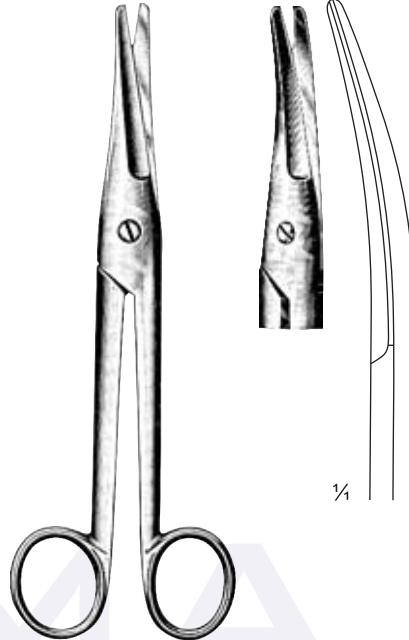

Mayo-Noble

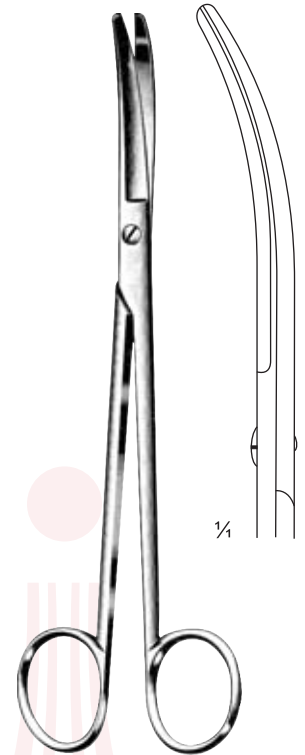

Wertheim

cm	in.	straight	curved	straight	curved	curved
14.5	5 ½					DC03-033-14
16.5	6 ½	DC03-025-16	DC03-027-16			
17.0	6 ¾			DC03-029-17	DC03-031-17	
19.5	7 ¾	DC03-025-19	DC03-027-19			DC03-033-19
21.0	8 ¼	DC03-025-21	DC03-027-21			
22.5	9					DC03-033-22



DC03-035-13 = 13 cm/5"
DC03-035-14 = 14.5 cm/5 ½"

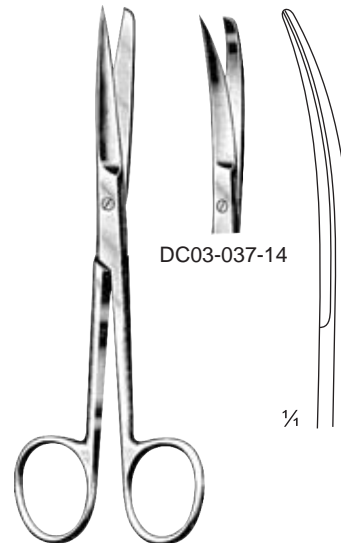

Deaver
DC03-036-14
14 cm/5 ½"

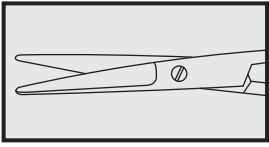

Mayo

Mayo-Harrington

Mayo-Stille

cm	in.	straight	curved	straight	curved	straight	curved
14.5	5 ½	DC03-039-14	DC03-041-14				
15.0	6	DC03-039-15	DC03-041-15			DC03-047-15	DC03-049-15
17.0	6 ¾	DC03-039-17	DC03-041-17			DC03-047-17	DC03-049-17
22.5	9			DC03-043-22	DC03-045-22		
23.0	9	DC03-039-23	DC03-041-23				
30.0	12				DC03-045-30		

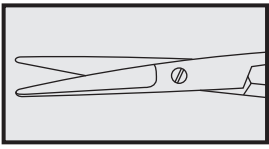

DC03-057-22
22cm/8 1/2"

Sims
DC03-051-20 = 20cm/8"
DC03-051-23 = 23cm/9"
straight

Sims
DC03-053-20 = 20cm/8"
DC03-053-23 = 23cm/9"
curved

Sims-Martin
DC03-055-22
22cm/8 1/2"

Siebold
DC03-059-24
24cm/9 1/2"
S-curved

Gynecological, Operating & Dissecting Scissors

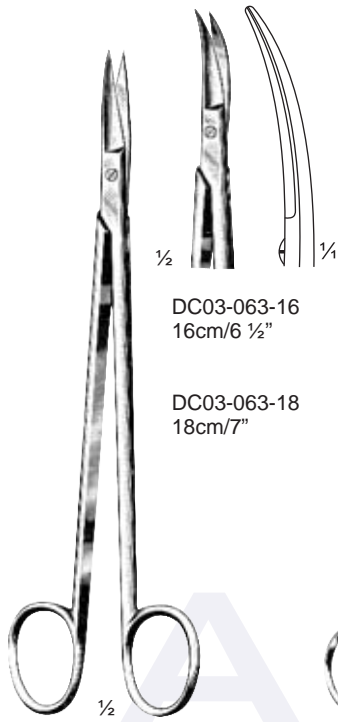
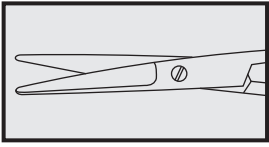

DC03-063-16
16cm/6 1/2"

DC03-063-18
18cm/7"

Kelly
DC03-061-16 = 16 cm/6 1/2"
DC03-061-18 = 18 cm/7"

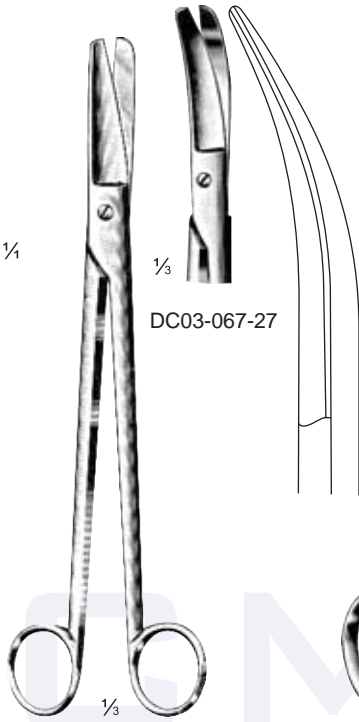

DC03-067-27

Dubois
DC03-065-27
27 cm/10 1/2"

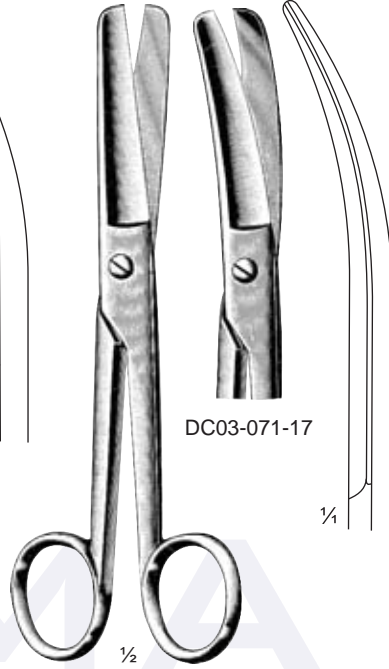

DC03-071-17

Doyen
DC03-069-17
17.5 cm/7"

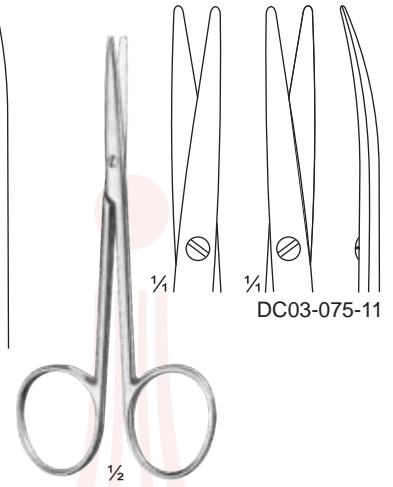

DC03-075-11

DC03-073-11
11.5 cm/4 1/2"

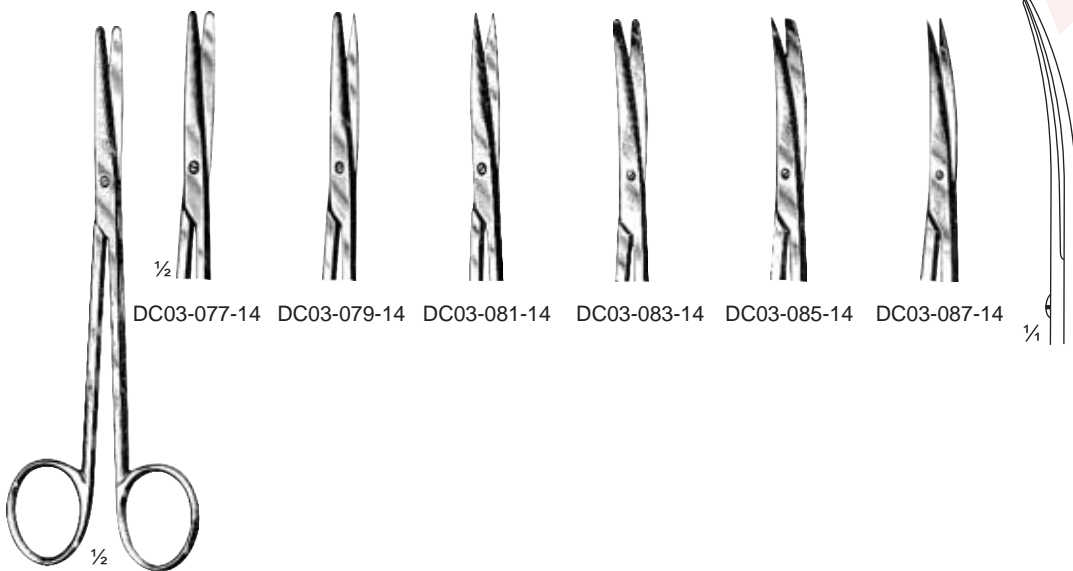

DC03-077-14 DC03-079-14 DC03-081-14 DC03-083-14 DC03-085-14 DC03-087-14

Metzenbaum
14.5 cm/5 1/2"

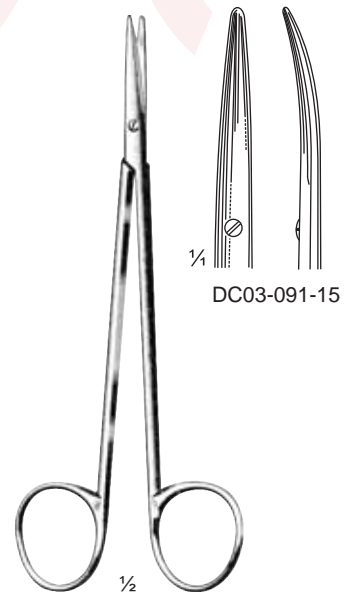

DC03-091-15

Metzenbaum
DC03-089-15
15 cm/6"

Dissecting Scissors

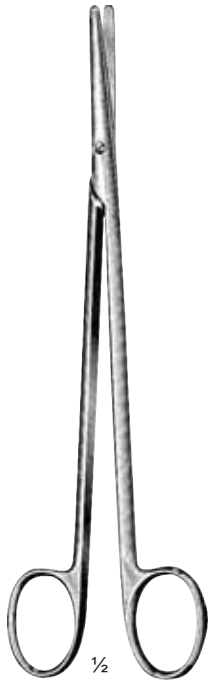
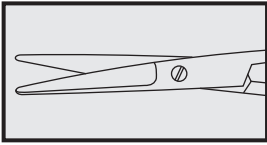

Metzzenbaum-Nelson



Fig. 1



Fig. 2



Fig. 3



Fig. 4



Fig. 5

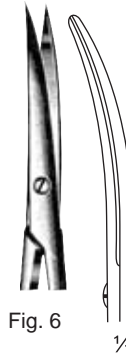
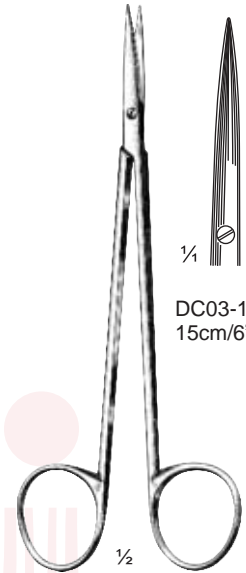

Fig. 6



DC03-107-15
15cm/6"

Nerv-Praparierschere
DC03-105-15
15 cm/6"
Nerve dissecting scissors

cm	in.	Fig. 1	Fig. 2	Fig. 3	Fig. 4	Fig. 5	Fig. 6
18.0	07	DC03-093-18	DC03-095-18	DC03-097-18	DC03-099-18	DC03-101-18	DC03-103-18
20.0	08	DC03-093-20	DC03-095-20	DC03-097-20	DC03-099-20	DC03-101-20	DC03-103-20
23.0	09	DC03-093-23	DC03-095-23	DC03-097-23	DC03-099-23	DC03-101-23	DC03-103-23
25.0	10	DC03-093-25	DC03-095-25	DC03-097-25	DC03-099-25	DC03-101-25	DC03-103-25
28.0	11	DC03-093-28	DC03-095-28	DC03-097-28	DC03-099-28	DC03-101-28	DC03-103-28
30.0	12	DC03-093-30	DC03-095-30	DC03-097-30	DC03-099-30	DC03-101-30	DC03-103-30

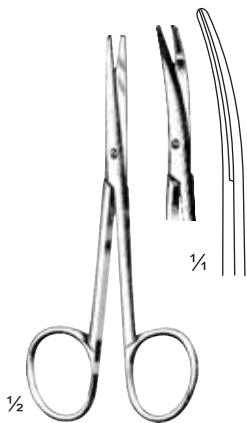

Lexer-Baby
DC03-109-10
10 cm/4"

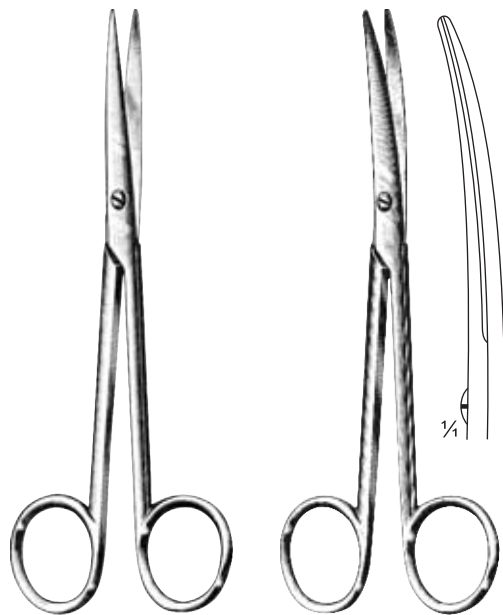

Lexer
DC03-111-16 = 16 cm/6 1/4"
DC03-111-21 = 21 cm/8 1/2"

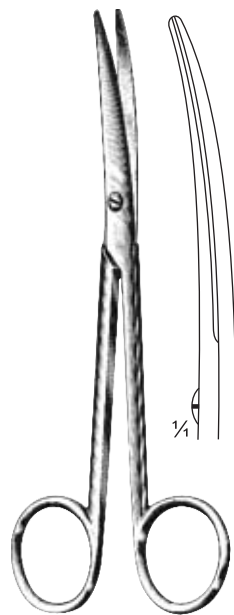

Lexer
DC03-113-16 = 16 cm/6 1/4"
DC03-113-21 = 21 cm/8 1/2"

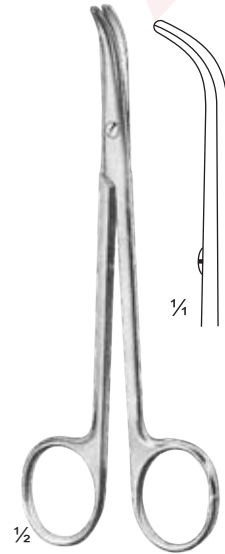

Fomon
DC03-115-14
13.5 cm/5 1/4"

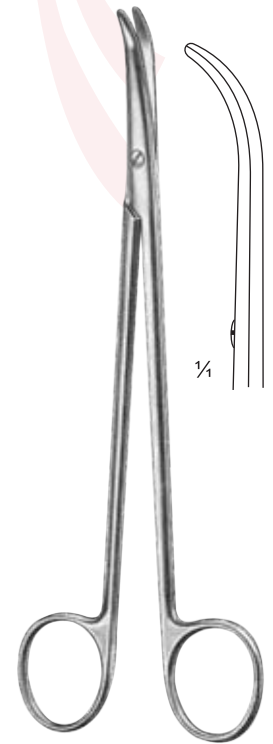

Thorek
DC03-117-19
19 cm/7 1/2"

Fine Dissecting Scissors

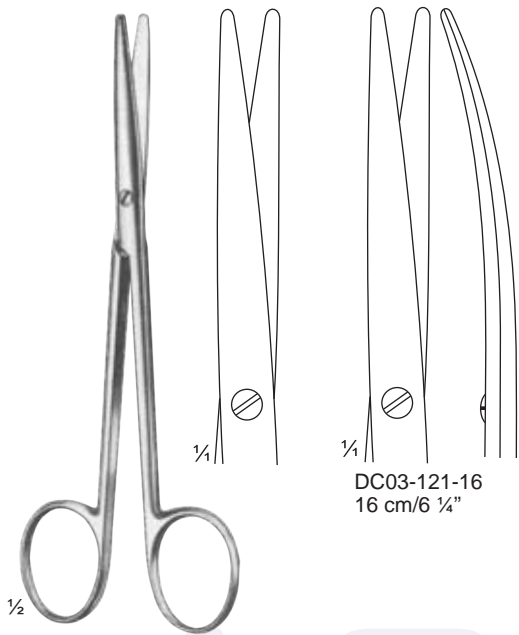
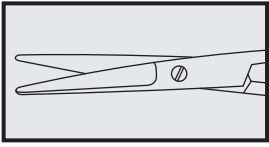

Lexer-Fino
DC03-119-16
16 cm/6 1/4"

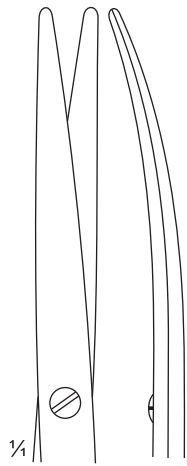

DC03-121-16
16 cm/6 1/4"

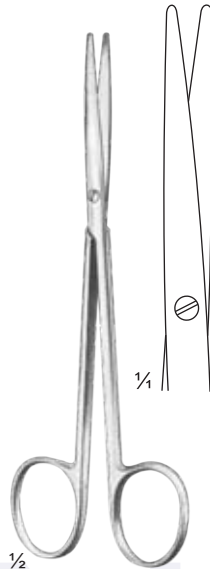

Metzenbaum-Fino
DC03-123-14
14.5 cm/5 1/2"



DC03-125-14
14.5 cm/5 1/2"

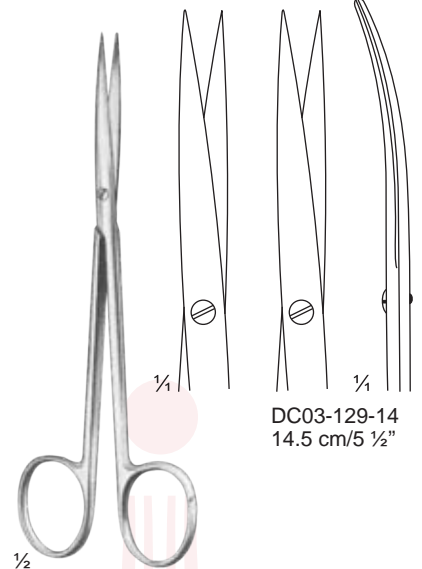

Metzenbaum-Fino
DC03-127-14
14.5 cm/5 1/2"

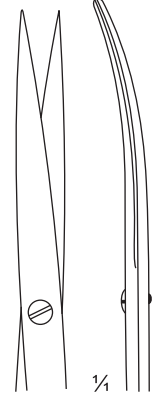

DC03-129-14
14.5 cm/5 1/2"

ACMA
INTERNATIONAL

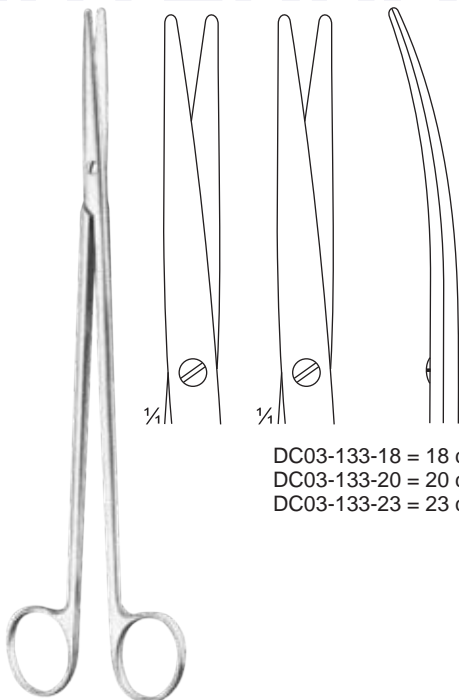

Metzenbaum-Fino
DC03-131-18 = 18 cm/7"
DC03-131-20 = 20 cm/8"
DC03-131-23 = 23 cm/9"

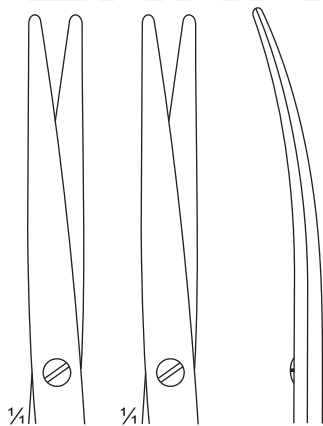

DC03-133-18 = 18 cm/7"
DC03-133-20 = 20 cm/8"
DC03-133-23 = 23 cm/9"

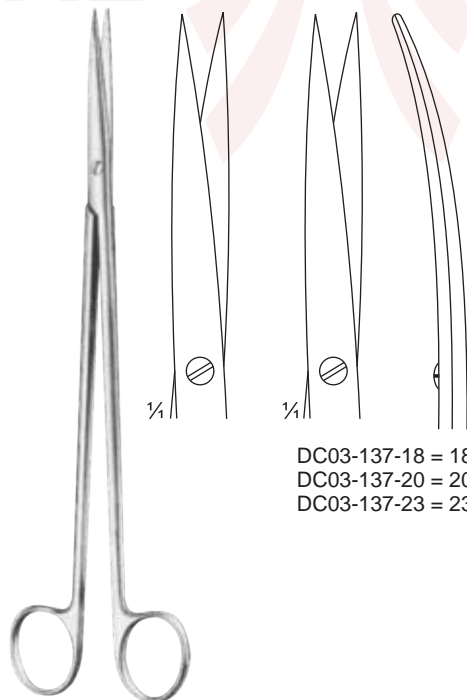

Metzenbaum-Fino
DC03-135-18 = 18 cm/7"
DC03-135-20 = 20 cm/8"
DC03-135-23 = 23 cm/9"

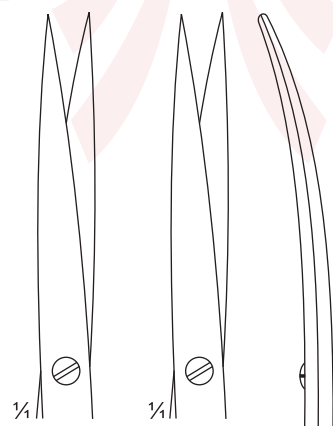

DC03-137-18 = 18 cm/7"
DC03-137-20 = 20 cm/8"
DC03-137-23 = 23 cm/9"

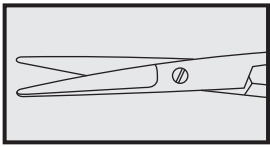

Fine Dissecting & Vascular Scissors

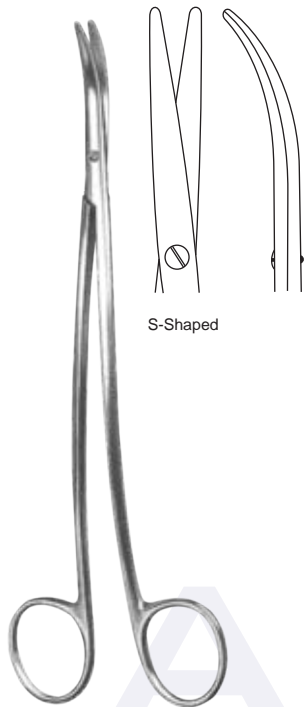

S-Shaped

Metzenbaum-Fino
 DC03-139-18 = 18 cm/7"
 DC03-139-20 = 20 cm/8"
 DC03-139-23 = 23 cm/9"

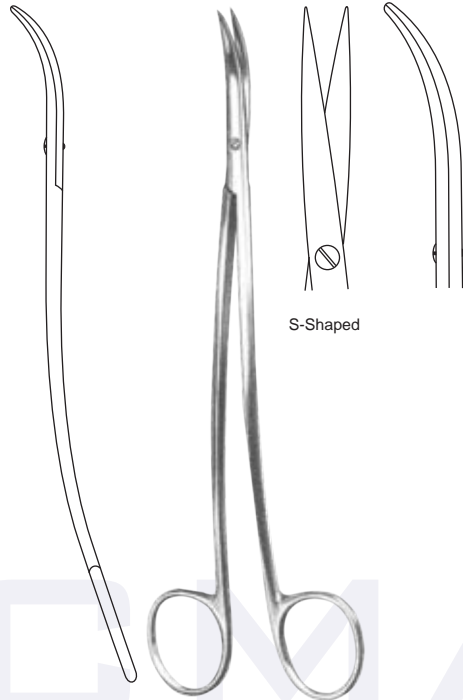

S-Shaped

Metzenbaum-Fino
 DC03-141-18 = 18 cm/7"
 DC03-141-20 = 20 cm/8"
 DC03-141-23 = 23 cm/9"

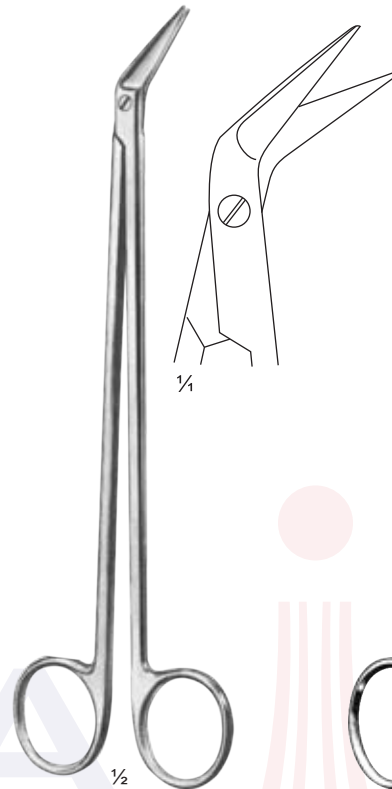

1/4

Potts-de Martel
 DC03-143-21 = 21 cm/8 1/4"
 DC03-143-24 = 24 cm/9 1/2"



1/2

Mc Indoe
 DC03-145-19
 19 cm/7 1/2"

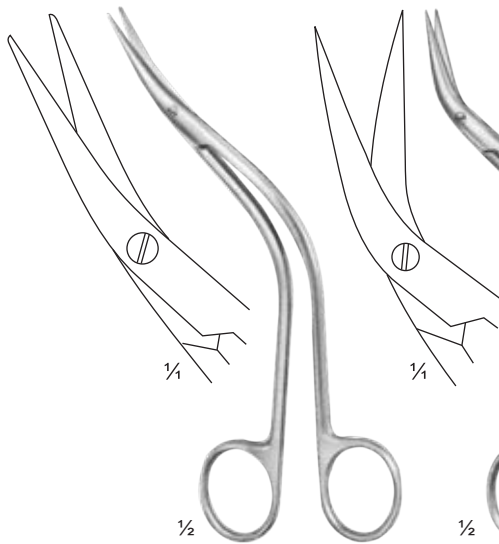

1/4

DeBakey
 DC03-147-20
 15.5 cm/6"

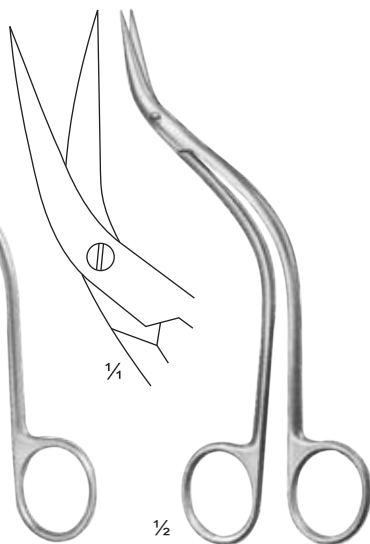

1/4

DeBakey
 DC03-149-45
 15.5 cm/6"



1/2

Favaloro
 DC03-151-90
 15 cm/6"



1/2

DC03-153-11
 11.5 cm/4 1/2"

Tonsil & Nasal Scissors, Episiotomy Scissors

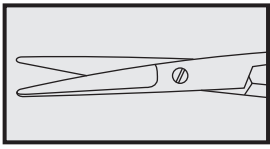

Cottle
DC03-155-15
16 cm/6 1/2"

Heymann
DC03-157-18
18 cm/7"
Nasal Scissors

Waldmann
DC03-159-18
18 cm/7 1/4"
Nasal Scissors

Braun-Stadler
DC03-161-14
14.5 cm/5 1/2"
Episiotomy Scissors

Braun-Stadler
DC03-163-22
22 cm/8 3/4"
Episiotomy Scissors



Beottcher
DC03-165-18
18 cm/7"
Tonsil Scissors

Prince
DC03-167-16
17.5 cm/7"
Tonsil Scissors

Dean
DC03-169-16
17 cm/6 3/4"
Tonsil Scissors

Good
DC03-171-19
19 cm/7 1/2"
Tonsil Scissors

Fomon
DC03-173-15
15 cm/6"

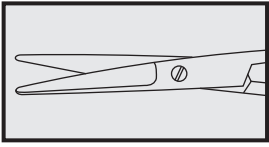

Rees (Face Lifting)
17 cm/6 3/4"

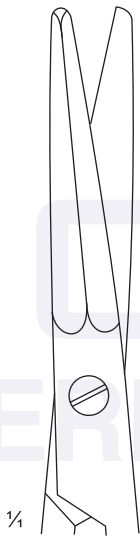

DC03-175-17
straight



DC03-176-17
curved

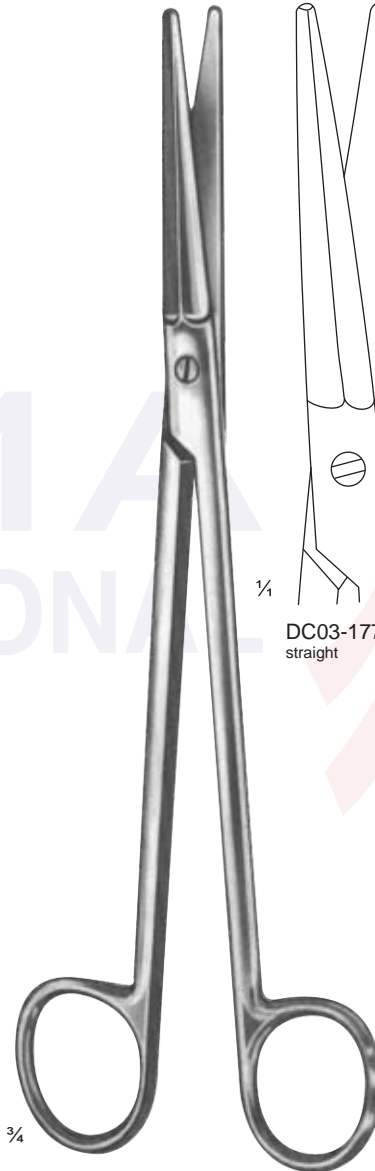

Gorney
20 cm/8"

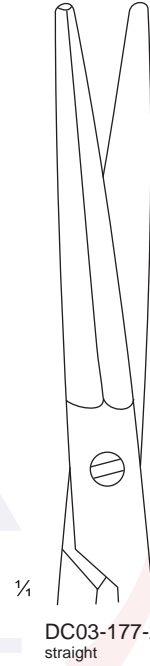

DC03-177-20
straight

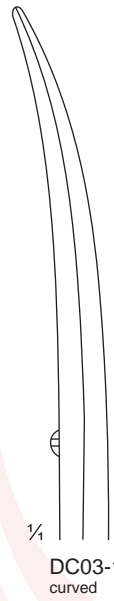

DC03-178-20
curved

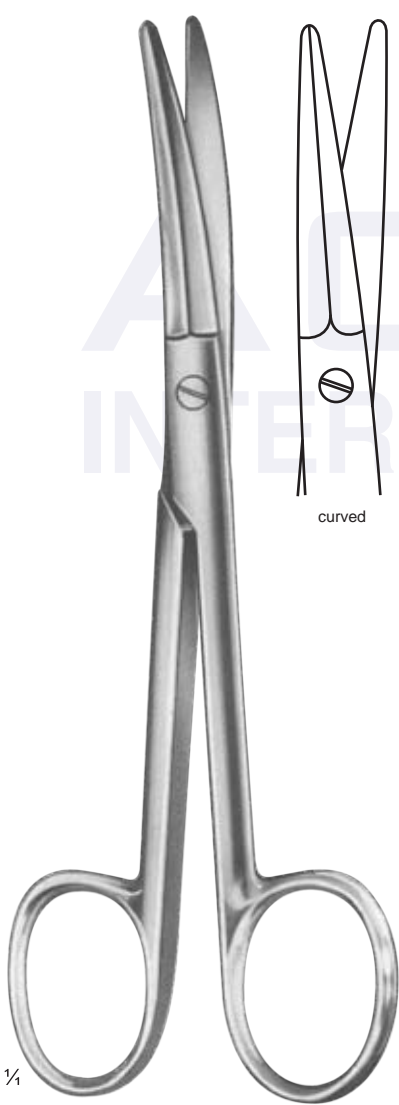
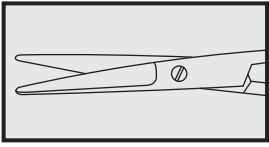

Aufricht
DC03-179-14
14.5cm/5 3/4"

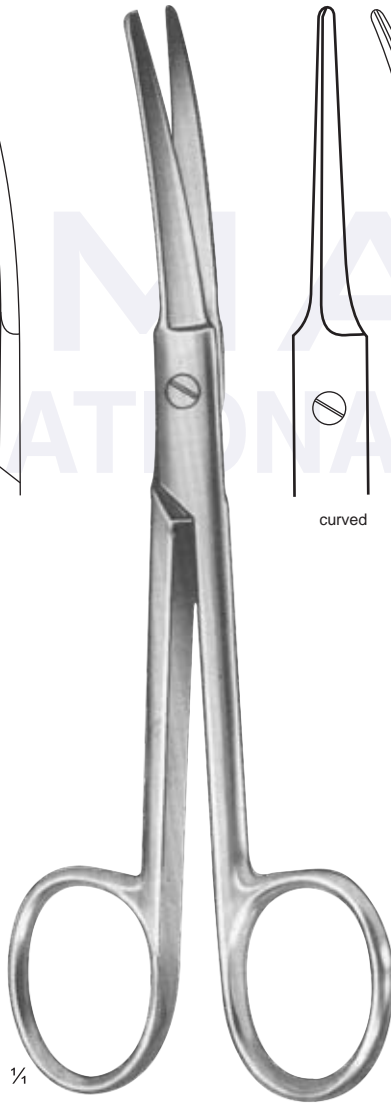

Brown (Mod.)
DC03-181-14
14.5cm/5 3/4"

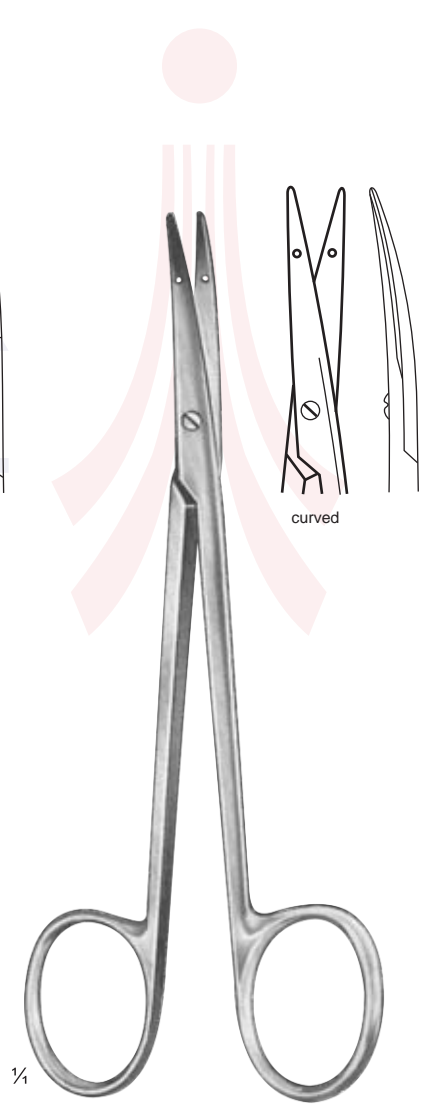

Littler Plastic
DC03-183-12
12cm/4 3/4"

Thorax & Vascular Scissors

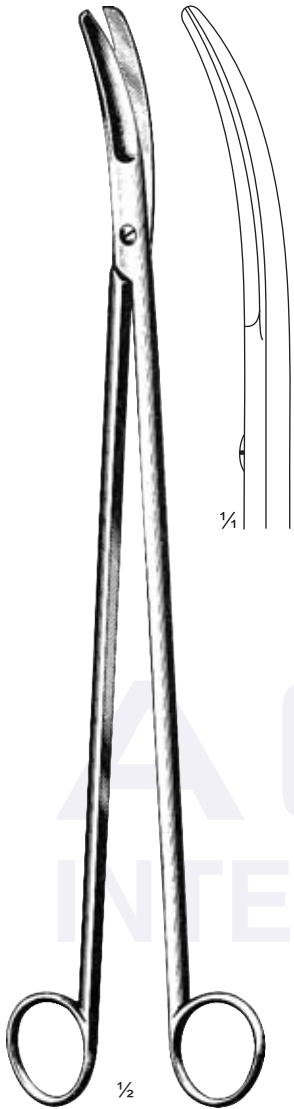
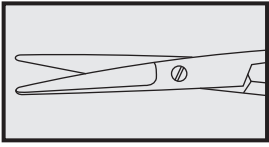

Crafoord
DC03-185-30
30 cm/12"

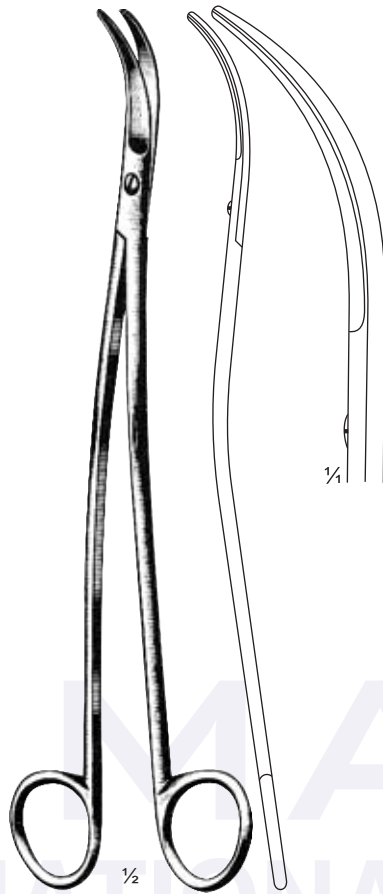

Satinsky
DC03-187-24
24.5 cm/10"

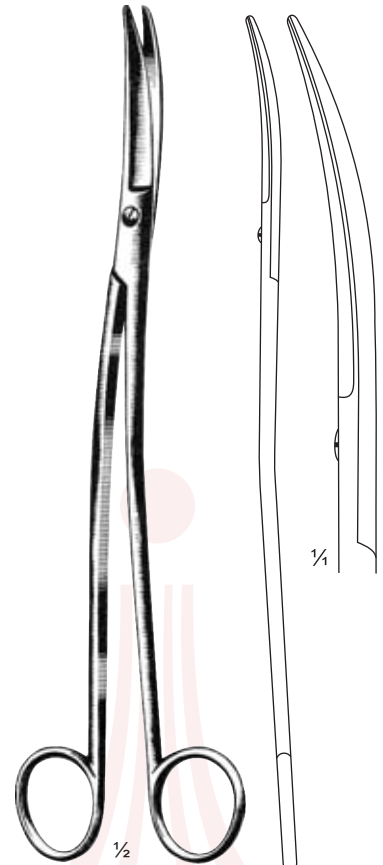

Klinkenbergh-Loth
DC03-189-23
23 cm/9"

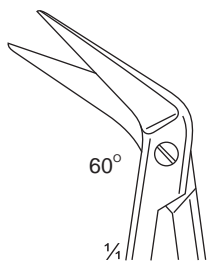

60°
DC03-191-19

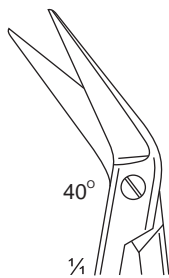

40°
DC03-193-19

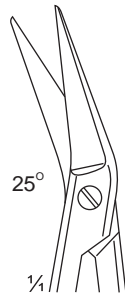

25°
DC03-195-19

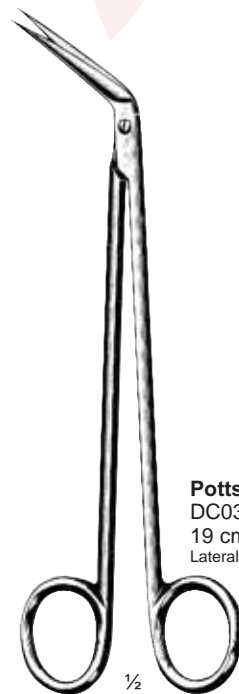

Potts-Smith
DC03-191-19 - DC03-195-19
19 cm/7 1/2"
Laterally angled

Scissors for Vascular Surgery

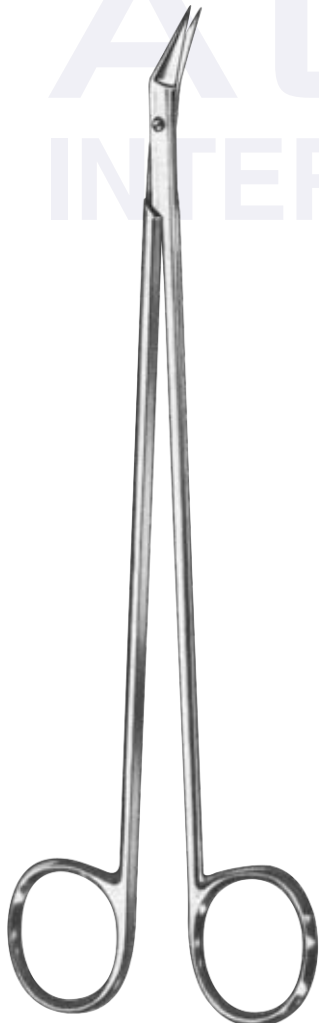
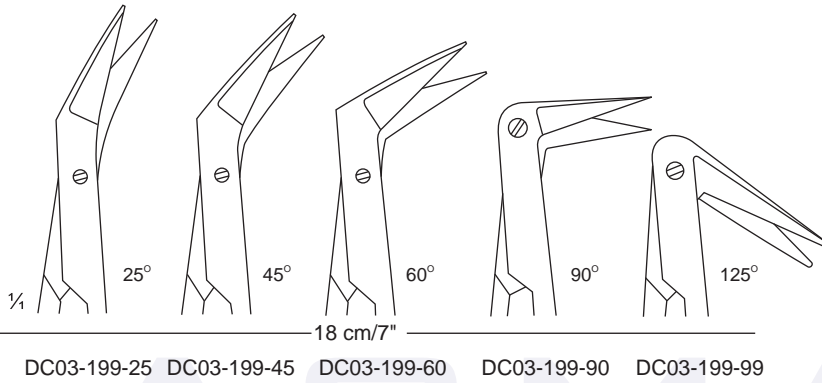
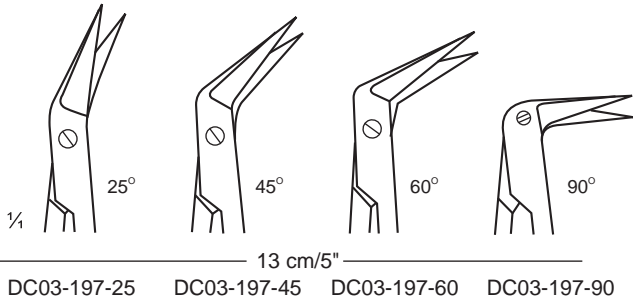
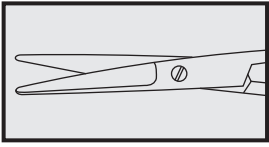

Diethrich
DC03-197-25 - DC03-199-99

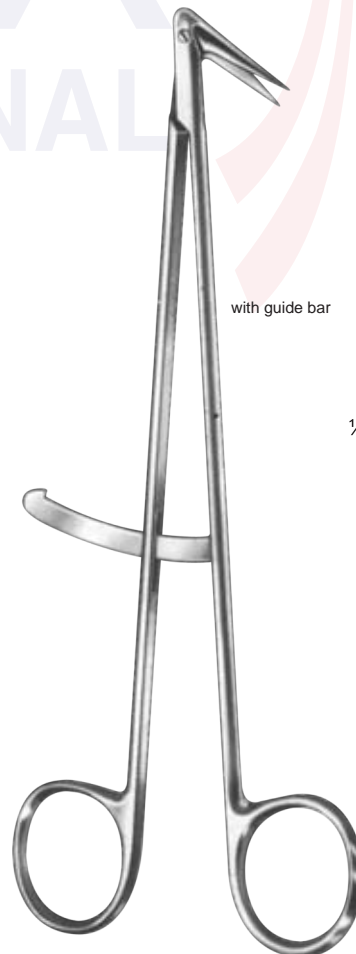

Diethrich
DC03-201-99
18 cm/7"

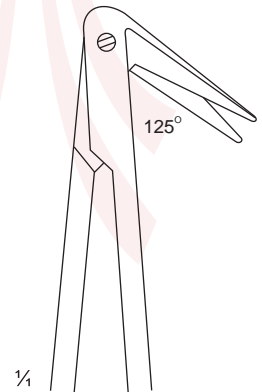

with guide bar

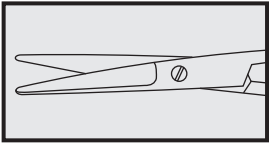

Scissors for Vascular Surgery

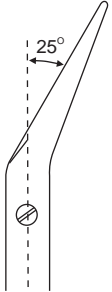

DC02-203-25
16 cm/6 1/4"

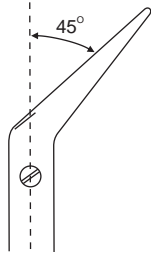

DC02-203-45
16 cm/6 1/4"

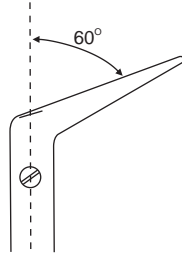

DC02-203-60
16 cm/6 1/4"

DC02-205-25
23 cm/9"

DC02-205-45
23 cm/9"

DC02-205-60
23 cm/9"

DC02-207-25
28 cm/11"

DC02-207-45
28 cm/11"

DC02-207-60
28 cm/11"

ACMA
INTERNATIONAL



DeBakey

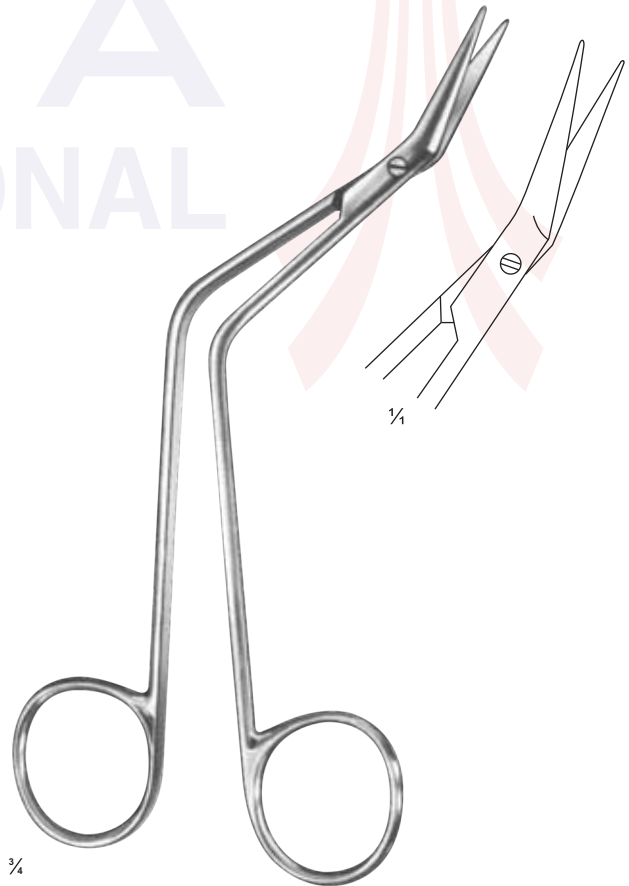

Coronary
DC02-209-17
17 cm/6 3/4"

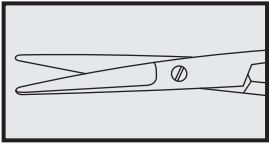

Fine Operating Scissors & Eye Scissors

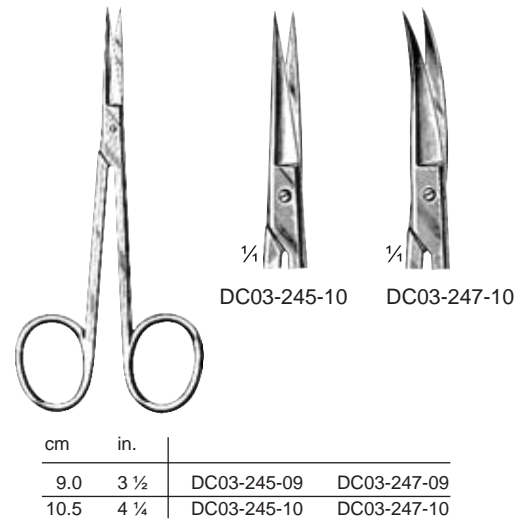
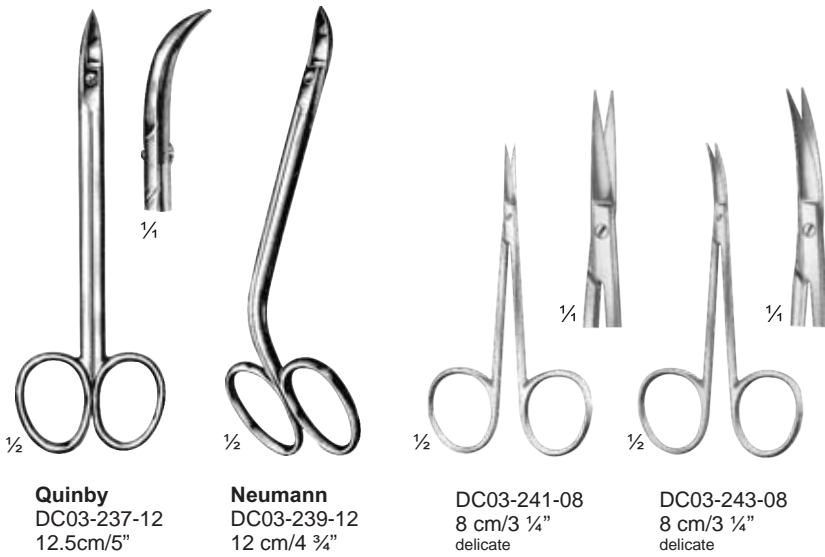
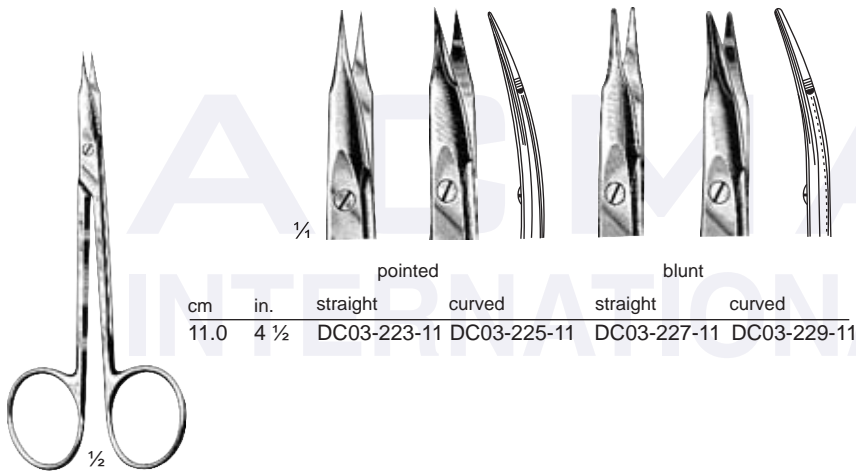

Fine Operating Scissors & Neurosurgical Scissors

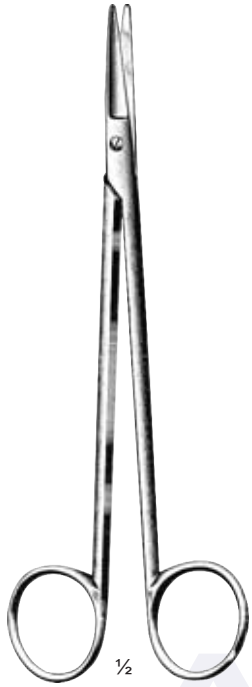
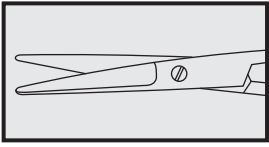

Toennis
DC03-249-18
18 cm/7"

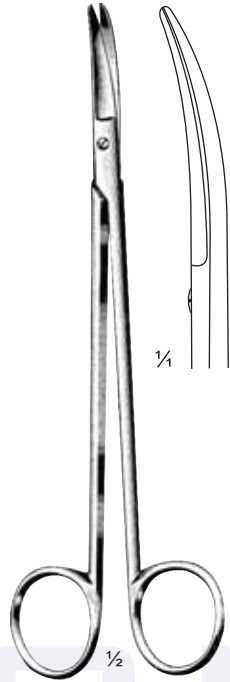

Toennis
DC03-251-18
18 cm/7"

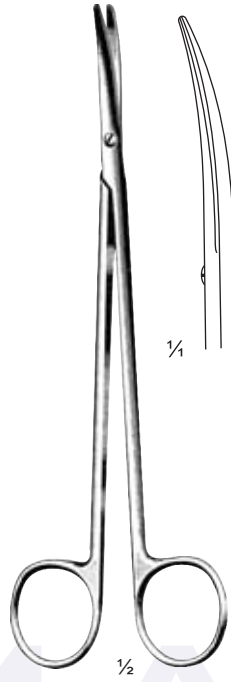

Toennis-Adson
DC03-253-17
17.5 cm/7"

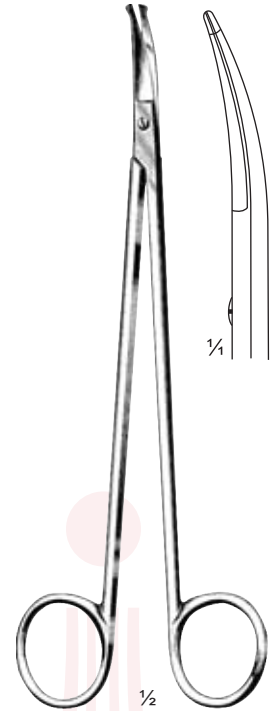

Strully
DC03-255-22
22 cm/8 1/2"

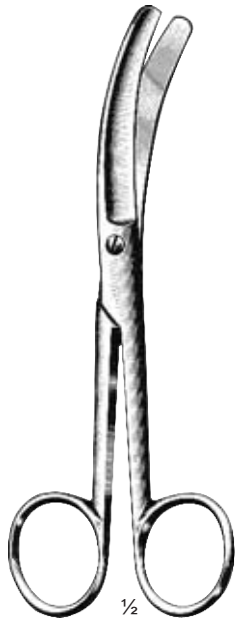

Busch
DC03-257-16
16 cm/6 1/4"



Dandy
DC03-259-17
17 cm/6 3/4"



Schmieden-Taylor
DC03-261-17
17 cm/6 3/4"



Mod. USA
DC03-263-10
10.5 cm/4 1/4"

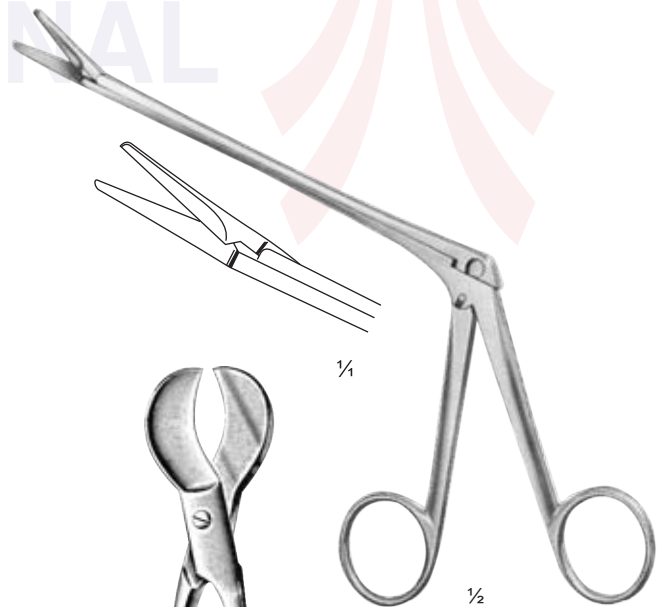

Olivecrona
DC03-265-23
23 cm/9"

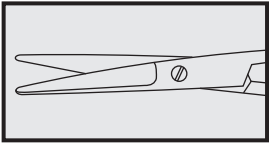

Gum Scissors

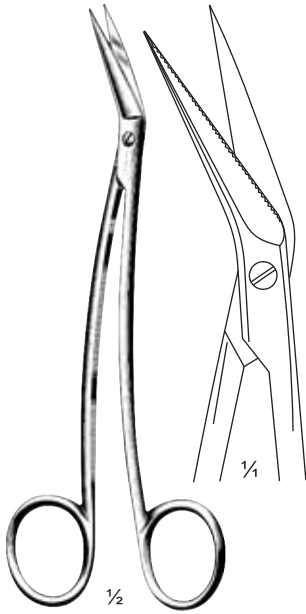

Locklin
DC03-267-16
16 cm/6 1/4"

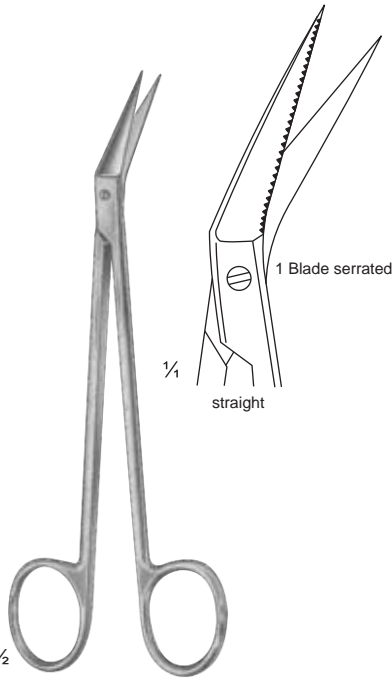

Locklin
DC03-269-16
16 cm/6 1/4"

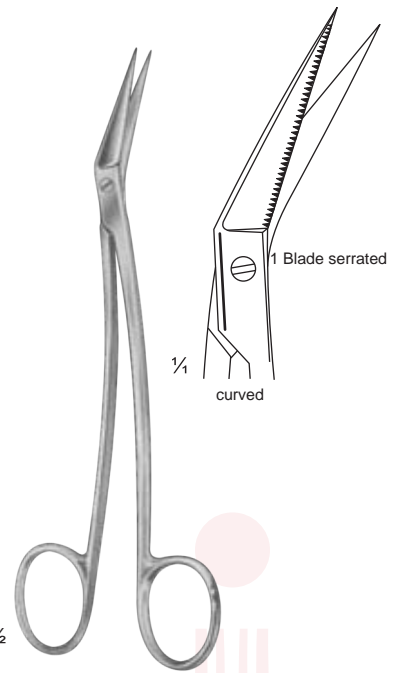

Locklin
DC03-271-16
16 cm/6 1/4"

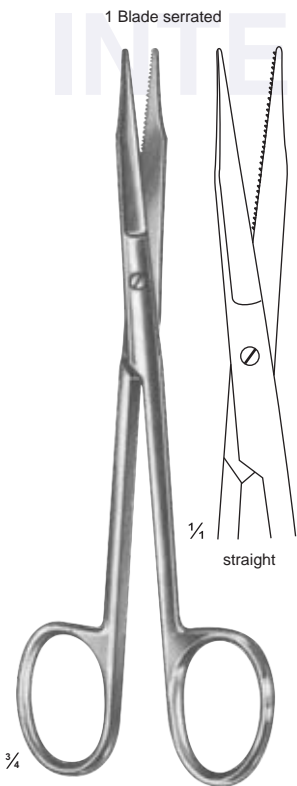

Goldmann-Fox
DC03-273-13
13 cm/5"
Umbilical Scissors

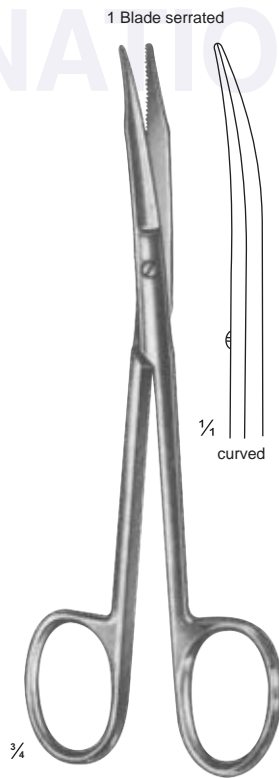

Goldmann-Fox
DC03-275-13
13 cm/5"

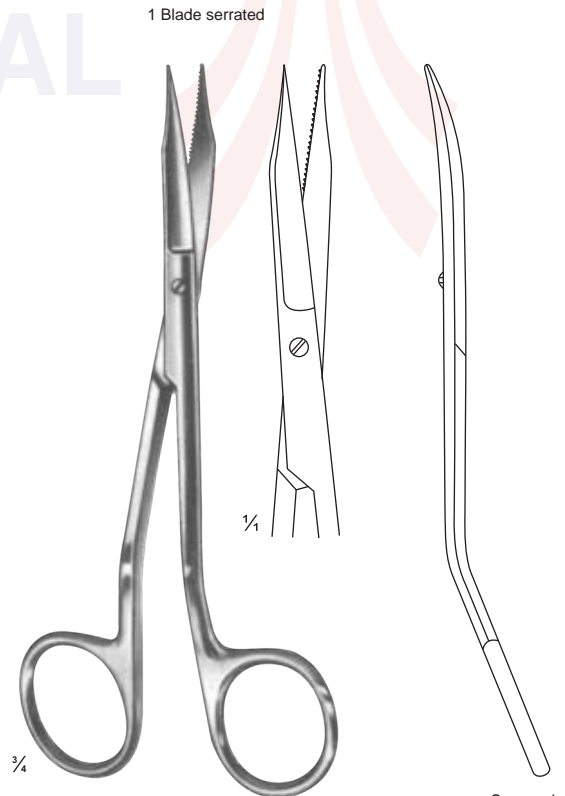

Goldmann-Fox
DC03-277-13
13 cm/5"
Umbilical Scissors

Ligature Scissors

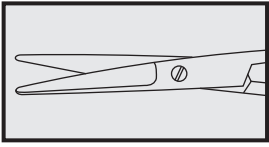

DC03-279-13
13 cm/5"



Spencer
DC03-281-09
9 cm/3 1/2"

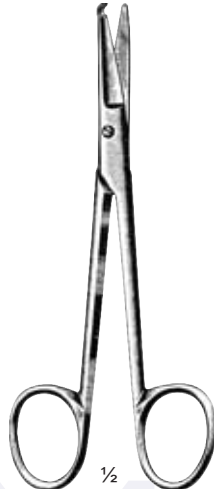

Spencer
DC03-283-13
13 cm/5"



Buck
DC03-285-14 = 14.5 cm/5 1/2"
DC03-285-18 = 18 cm/7"



Littauer
DC03-287-14
14 cm/5 1/2"

ACMA
INTERNATIONAL



DC03-289-10
10.5 cm/4"
saw edge

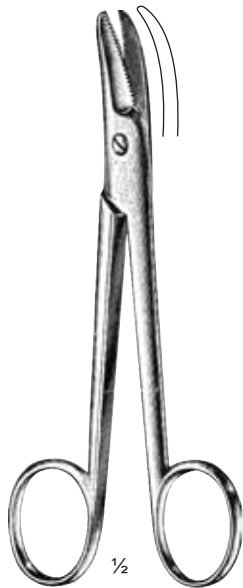

Mod. Martin
DC03-291-15
15.5 cm/6"
saw edge

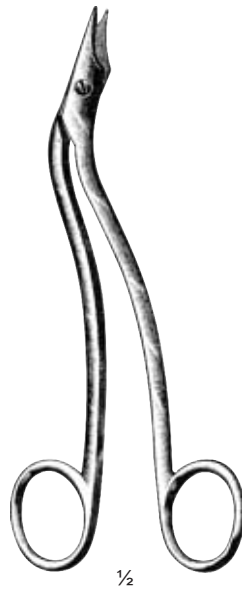

Heath
DC03-293-15
15 cm/6"

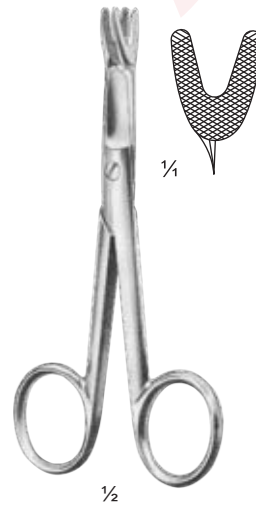

Schoemaker-Loth
DC03-295-13
13 cm/5"

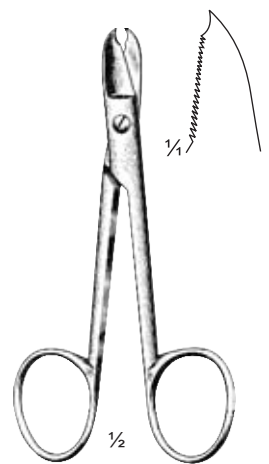

DC03-297-12
12 cm/4 3/4"
saw edge

Enterotomy, Nail Splitting Scissors & Wire & Plate Shears

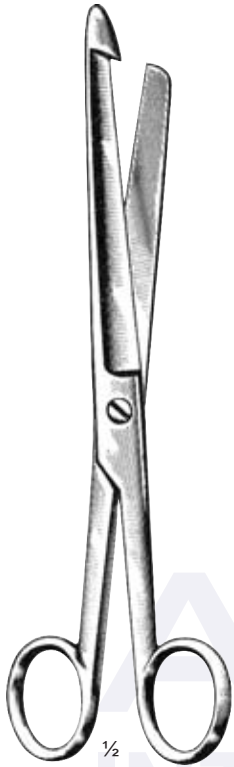
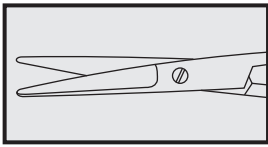

DC03-299-21
21 cm/8 1/2"

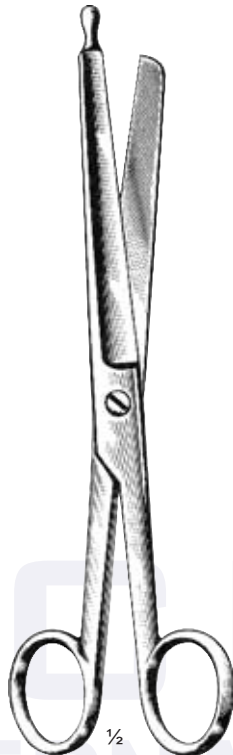

DC03-301-21
21 cm/8 1/2"



DC03-303-13 = 13 cm/5"
DC03-303-15 = 15 cm/6"

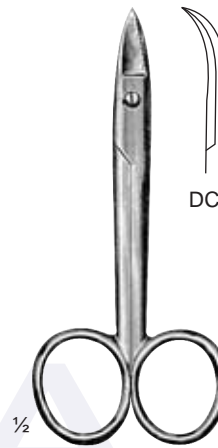

Special
DC03-305-12
saw edge



DC03-307-12

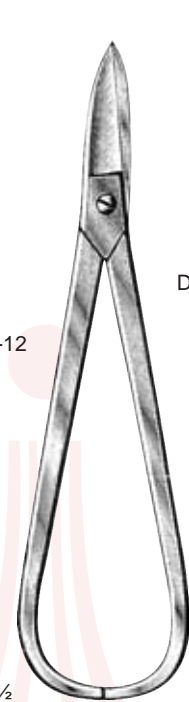

DC03-309-18
18 cm/7"



DC03-311-18

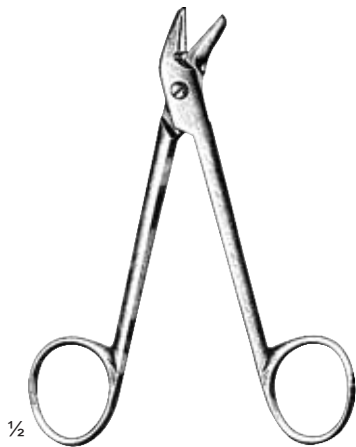

Universal
DC03-313-12
12 cm/4 3/4"
saw edge

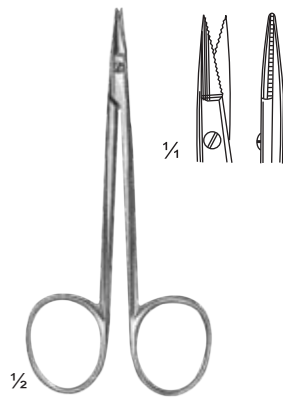

DC03-315-10
10 cm/4"
saw edge

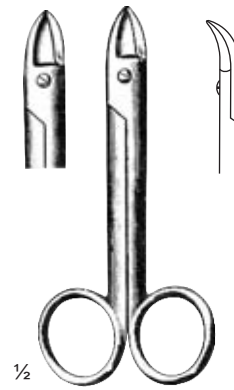

1/2

Beebee
blunt

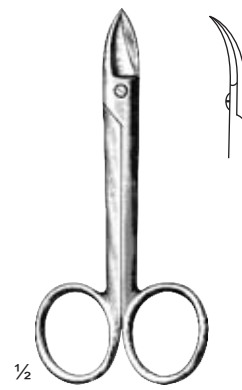

1/2

Beebee
sharp

cm	in.	DC03-317-10	DC03-319-10	DC03-321-10	DC03-323-10
10.0	4				

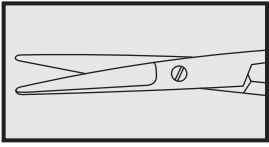

General & Dissecting Operating Scissors

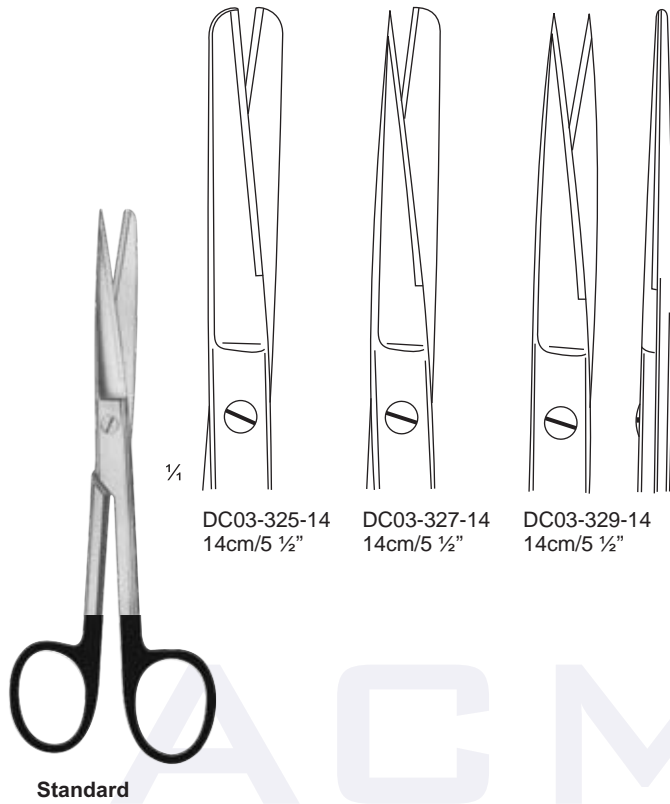

DC03-325-14
14cm/5 1/2"

DC03-327-14
14cm/5 1/2"

DC03-329-14
14cm/5 1/2"

Standard

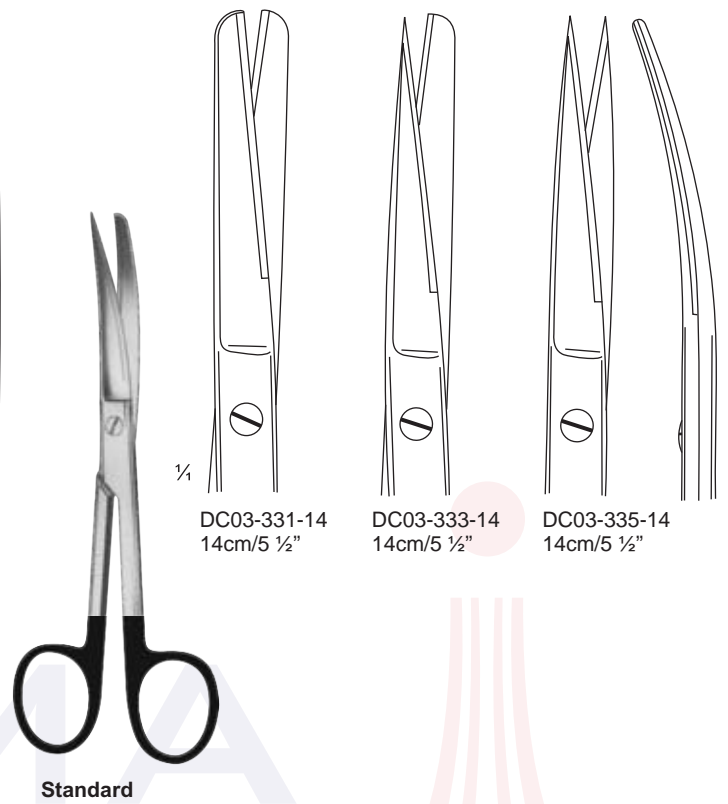

DC03-331-14
14cm/5 1/2"

DC03-333-14
14cm/5 1/2"

DC03-335-14
14cm/5 1/2"

Standard

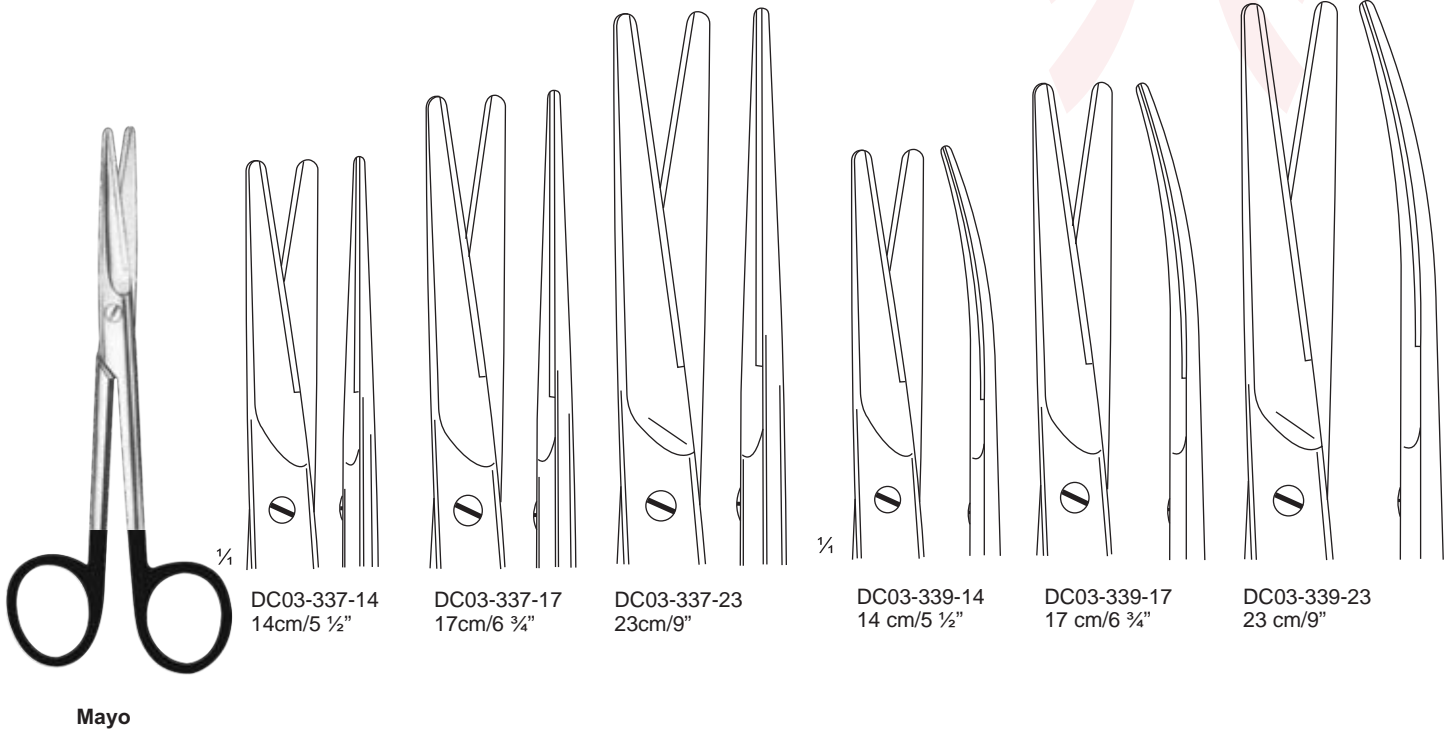

DC03-337-14
14cm/5 1/2"

DC03-337-17
17cm/6 3/4"

DC03-337-23
23cm/9"

DC03-339-14
14 cm/5 1/2"

DC03-339-17
17 cm/6 3/4"

DC03-339-23
23 cm/9"

Mayo

Dissecting Scissors

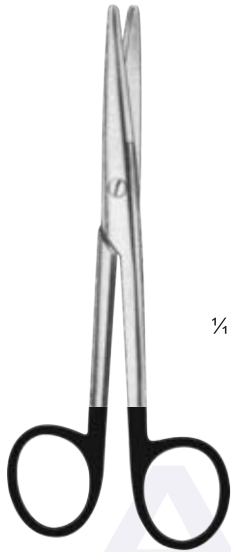
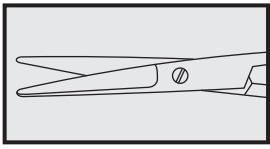

Mayo-Stille

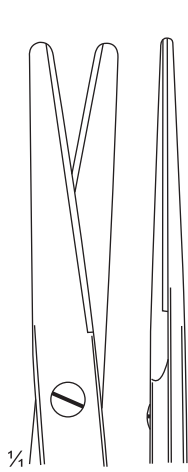

DC03-341-15
15cm/6"

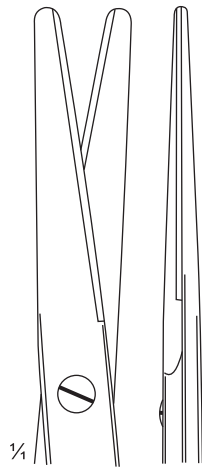

DC03-341-17
17cm/6 3/4"



DC03-343-15
15cm/6"



DC03-343-17
17cm/6 3/4"

ACMA
INTERNATIONAL



Mayo-Lexer

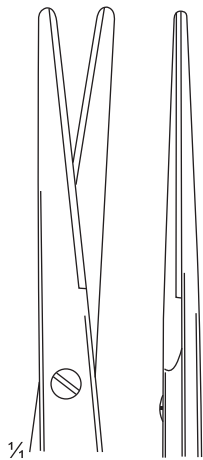

DC03-345-16
16cm/6 1/4"



DC03-347-16
16cm/6 1/4"



Goldman-Fox

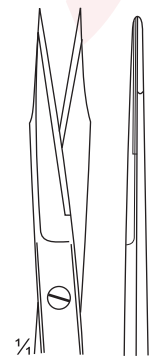

DC03-349-13
13cm/5"

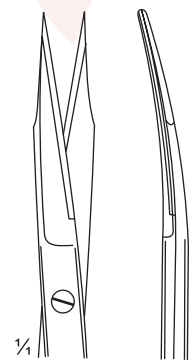

DC03-351-13
13cm/5"

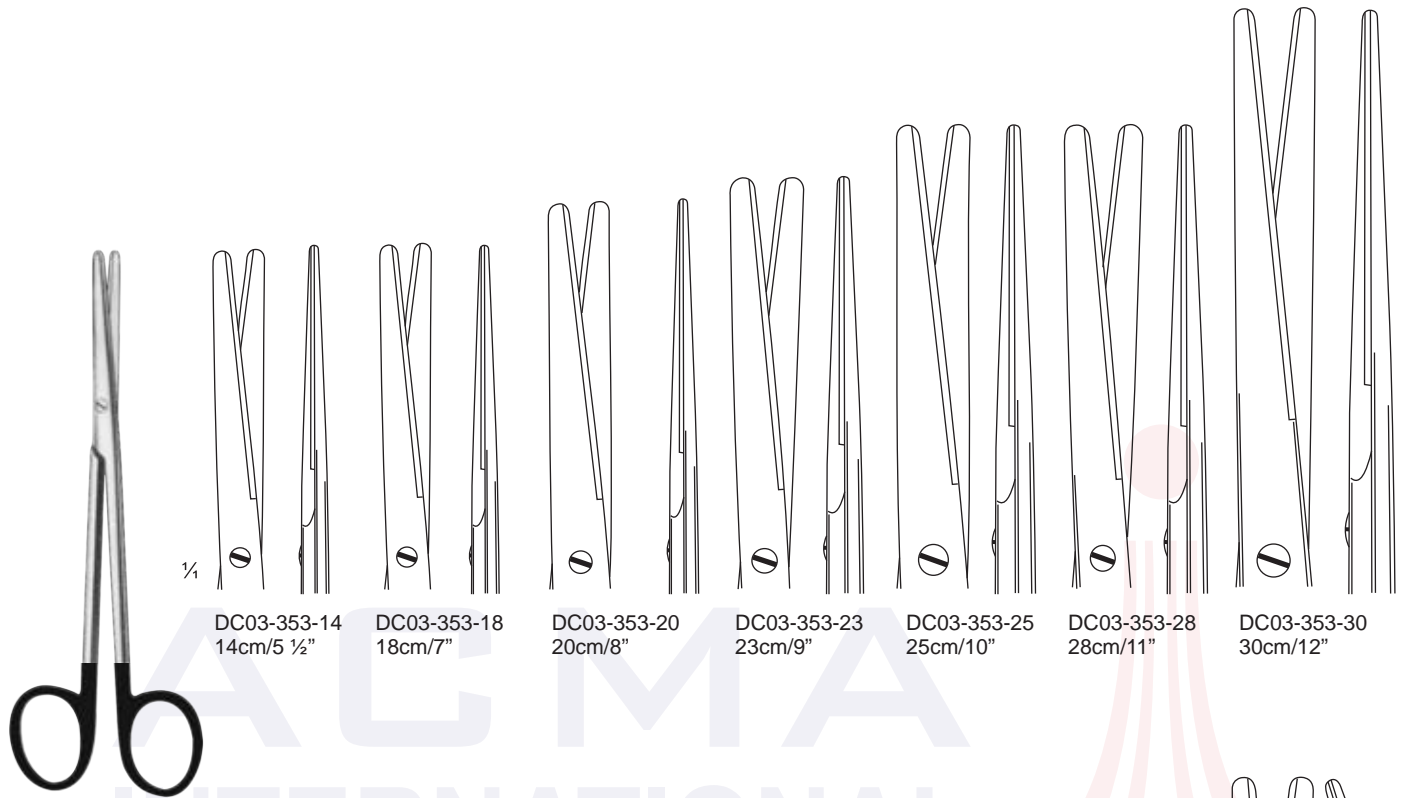
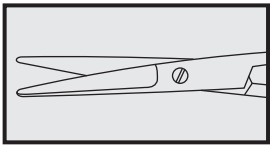

¼

DC03-353-14
14cm/5 ½"

DC03-353-18
18cm/7"

DC03-353-20
20cm/8"

DC03-353-23
23cm/9"

DC03-353-25
25cm/10"

DC03-353-28
28cm/11"

DC03-353-30
30cm/12"

Metzenbaum

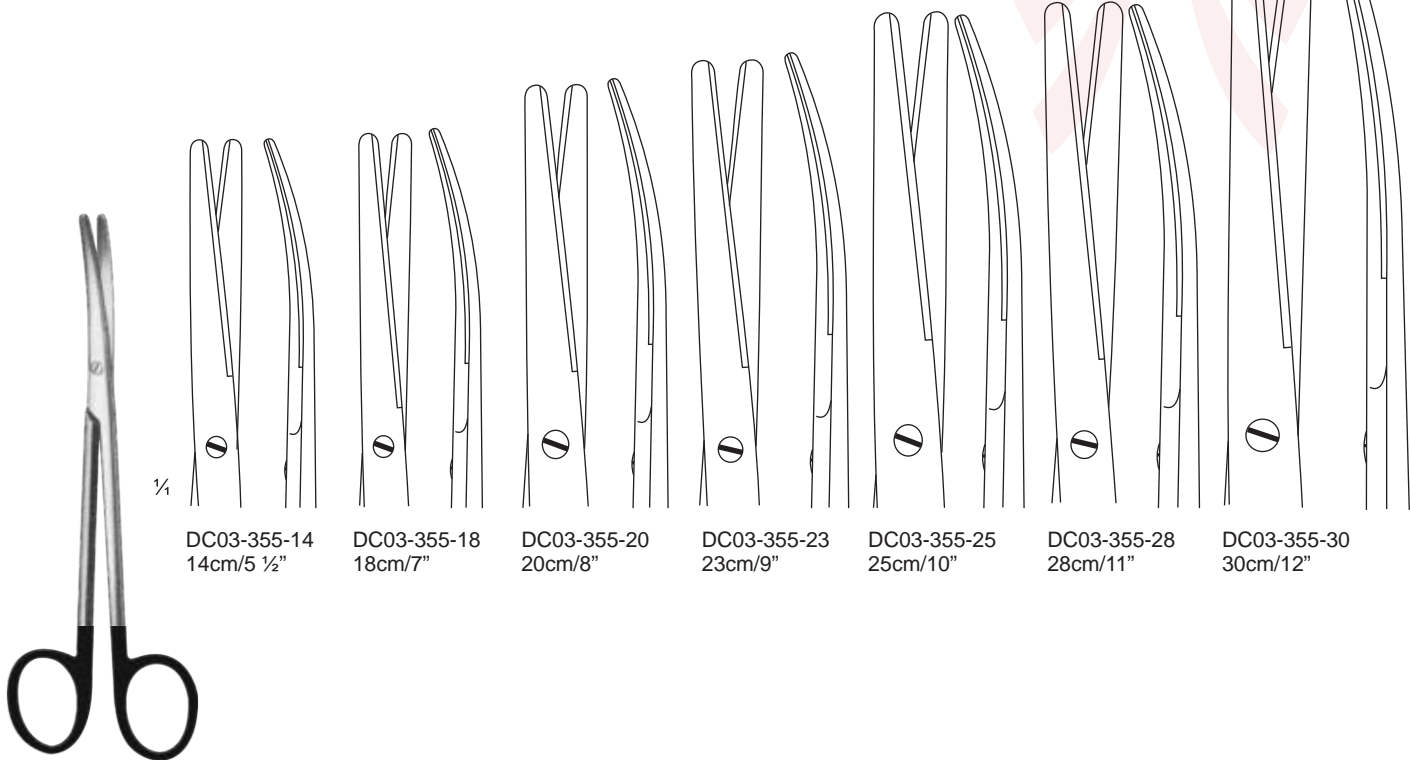

¼

DC03-355-14
14cm/5 ½"

DC03-355-18
18cm/7"

DC03-355-20
20cm/8"

DC03-355-23
23cm/9"

DC03-355-25
25cm/10"

DC03-355-28
28cm/11"

DC03-355-30
30cm/12"

Metzenbaum

Dissecting Scissors

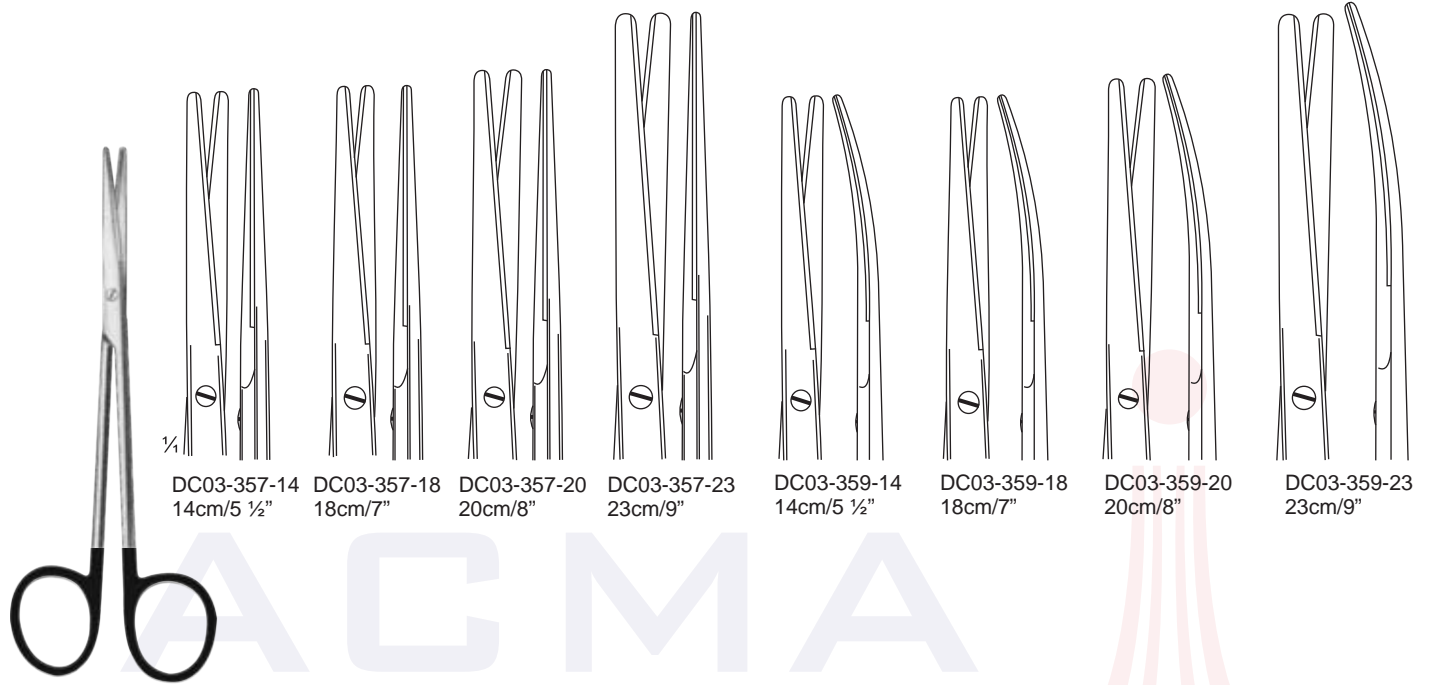
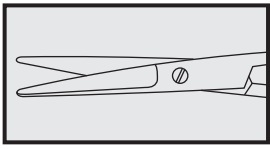

DC03-357-14
14cm/5 1/2"

DC03-357-18
18cm/7"

DC03-357-20
20cm/8"

DC03-357-23
23cm/9"

DC03-359-14
14cm/5 1/2"

DC03-359-18
18cm/7"

DC03-359-20
20cm/8"

DC03-359-23
23cm/9"



Metzenbaum-Fino

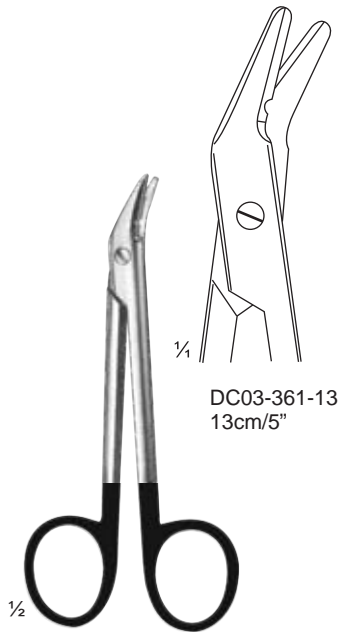

DC03-361-13
13cm/5"

Wire Cutter
Universal

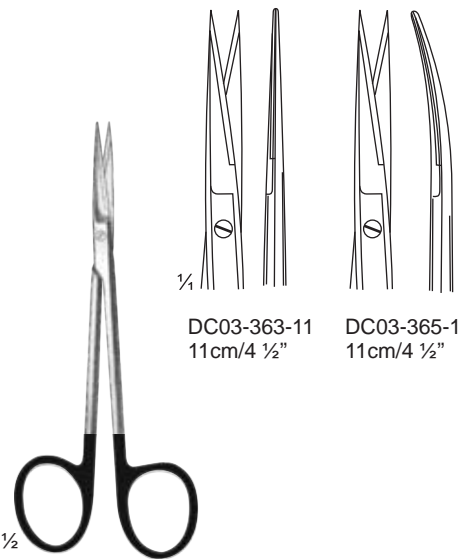

DC03-363-11
11cm/4 1/2"

DC03-365-11
11cm/4 1/2"

Iris

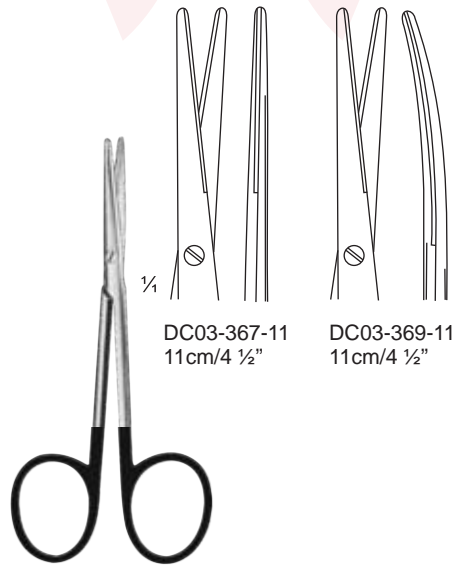

DC03-367-11
11cm/4 1/2"

DC03-369-11
11cm/4 1/2"

Strabismus

Dissecting Scissors

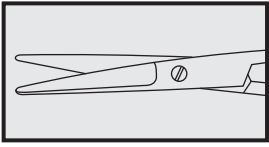

Metzenbaum-Fino

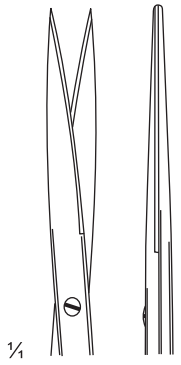

¼

DC03-371-14
14cm/5 ½"



DC03-371-18
18cm/7"



DC03-371-20
20cm/8"

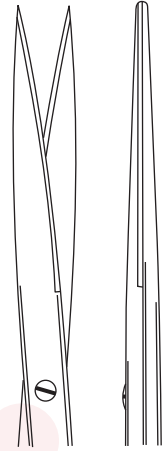

DC03-371-23
23cm/9"



Metzenbaum-Fino

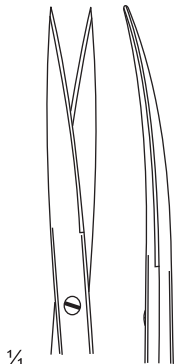

¼

DC03-373-14
14cm/5 ½"



DC03-373-18
18cm/7"



DC03-373-20
20cm/8"



DC03-373-23
23cm/9"

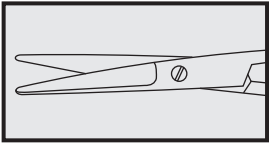

Vessel and Cardiac Scissors

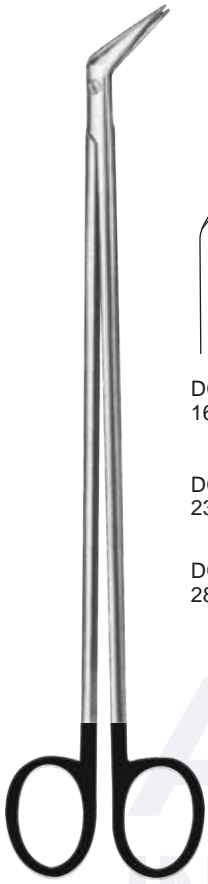

DeBakey

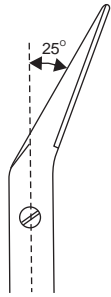

DC03-375-16
16cm/6 1/4"

DC03-377-23
23cm/9"

DC03-379-28
28cm/11"

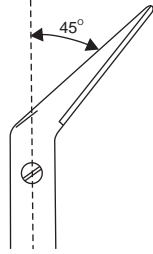

DC03-381-16
16cm/6 1/4"

DC03-383-23
23cm/9"

DC03-385-28
28cm/11"

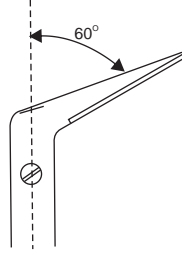

DC03-387-16
16cm/6 1/4"

DC03-389-23
23cm/9"

DC03-391-28
28cm/11"



Potts-Smith

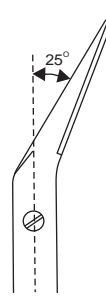

DC03-393-19
19cm/7 1/2"

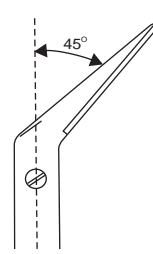

DC03-395-19
19cm/7 1/2"

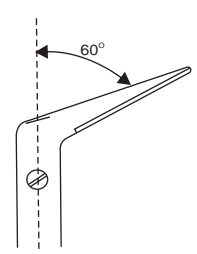

DC03-397-19
19cm/7 1/2"

Parametrium Scissors

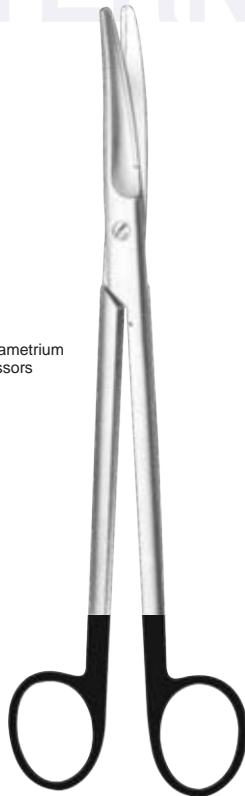

Parametrium

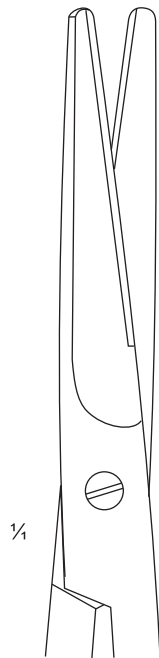

1/4

light curve



1/4

23cm/9"
DC03-399-23

strong curve

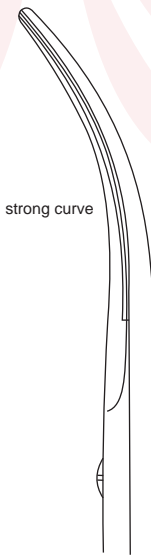

22cm/8 1/2"
DC03-401-22

