

4

Tweezers

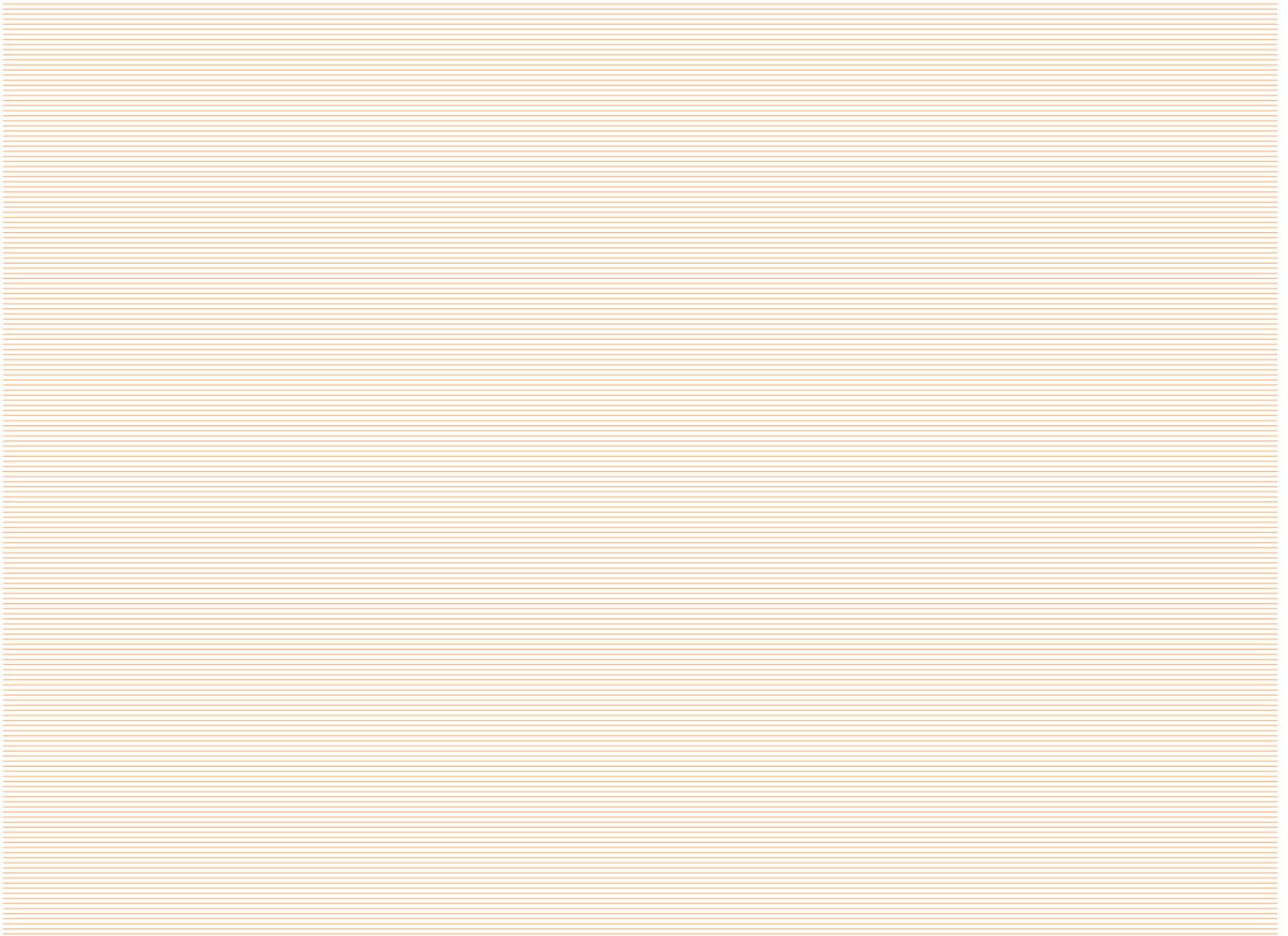

Dressing Forceps

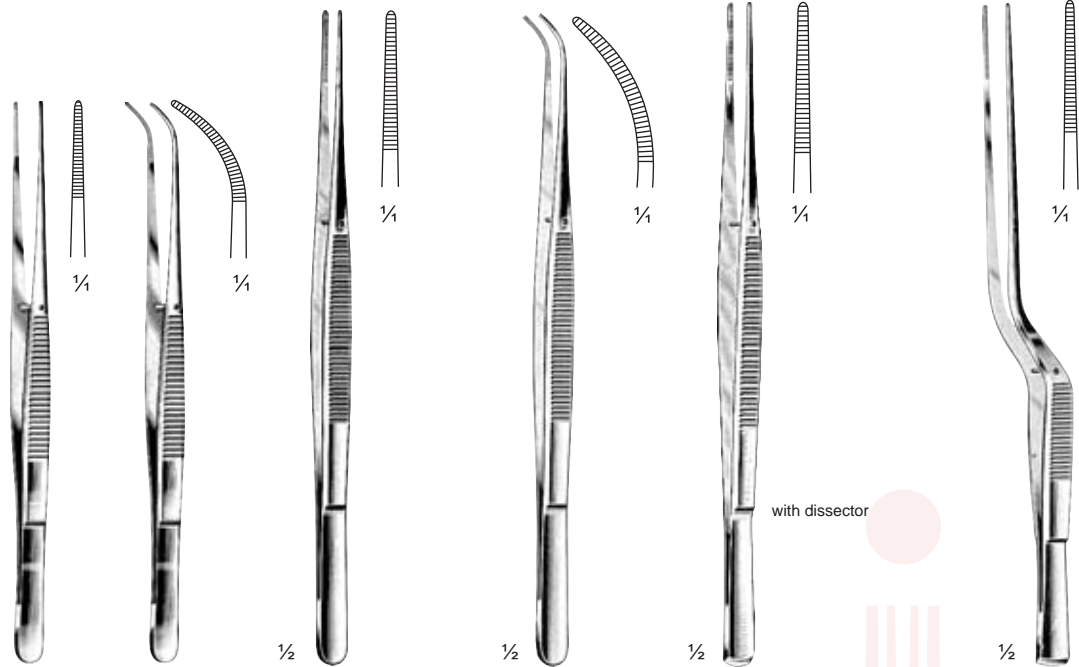
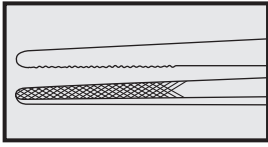

cm	in.	Semken	Taylor	Taylor	Taylor	Taylor
12.5	4	DC04-001-12 DC04-003-12				
15.5	6	DC04-001-15 DC04-003-15				
17.5	7		DC04-005-17	DC04-007-17	DC04-009-17	DC04-011-17

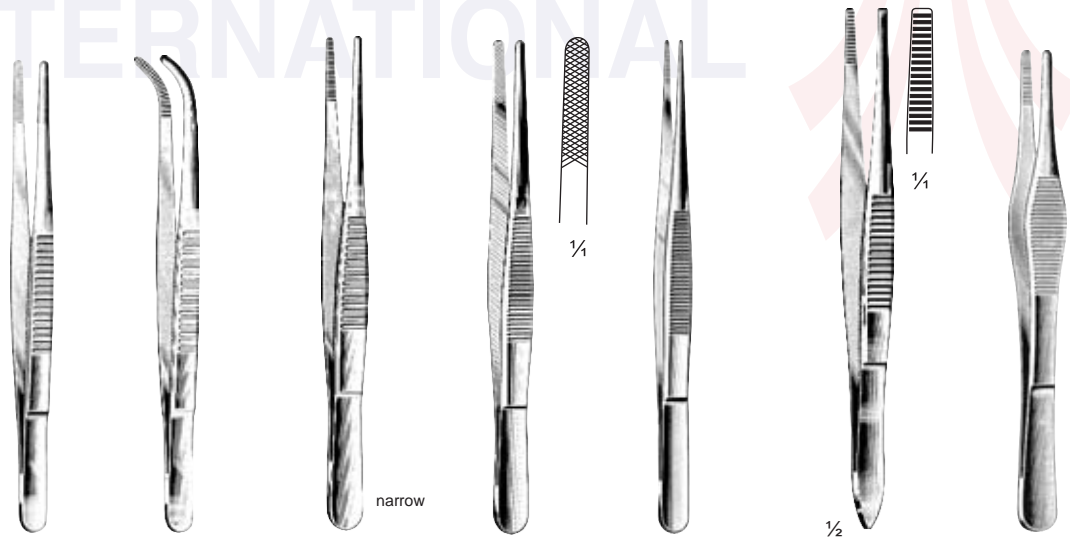

cm	in.	Standard	Standard	Standard	Standard	Stille	Mod. Martin
10.5	4 1/4	DC04-013-10					
11.5	4 1/2	DC04-013-11	DC04-015-11	DC04-017-11			
13.0	5	DC04-013-13	DC04-015-13	DC04-017-13	DC04-019-13	DC04-021-13	DC04-025-13
14.5	5 1/2	DC04-013-14	DC04-015-14	DC04-017-14	DC04-019-14	DC04-021-14	DC04-025-14
15.0	6					DC04-023-15	
16.0	6 1/4	DC04-013-16	DC04-015-16	DC04-017-16	DC04-019-16		
18.0	7	DC04-013-18	DC04-015-18	DC04-017-18			
20.0	8	DC04-013-20	DC04-015-20	DC04-017-20			
25.0	10	DC04-013-25		DC04-017-25			
30.0	12	DC04-013-30		DC04-017-30			

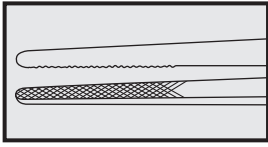

Dressing Forceps

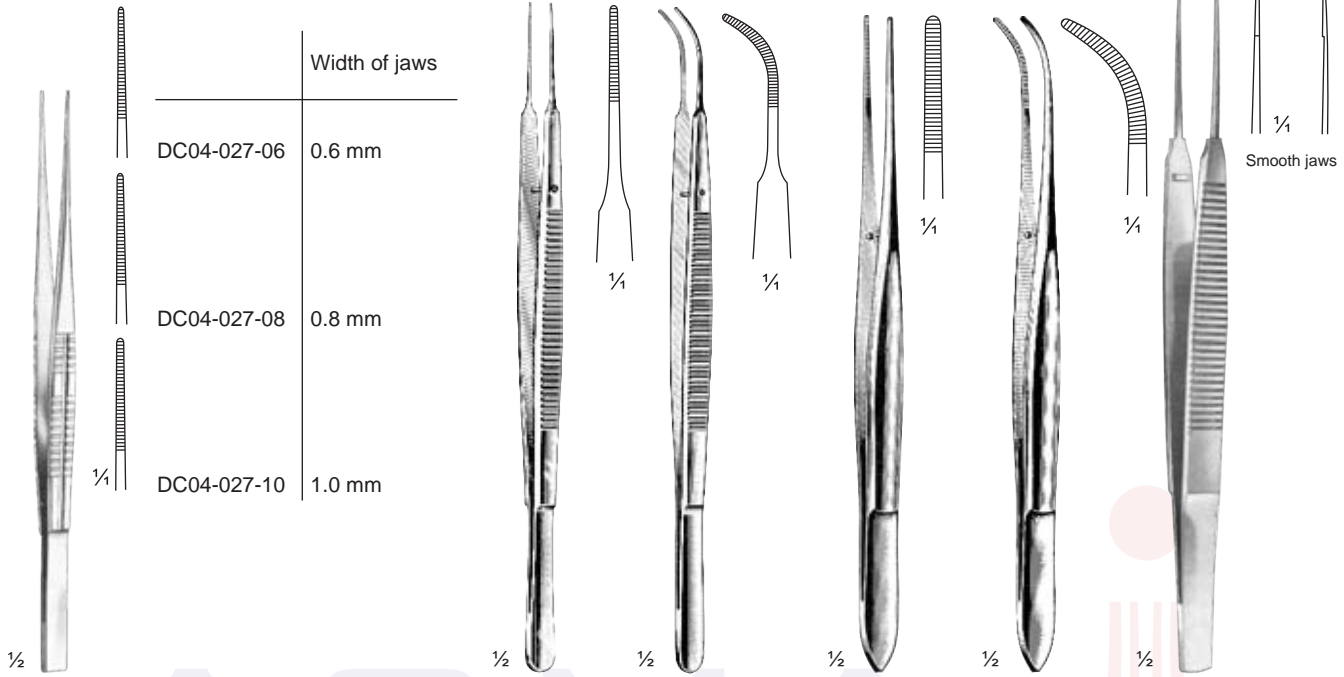

cm	in.	Gerald	Gerald	Cushing	Cushing	
14.0	5					DC04-037-14
17.5	7			DC04-033-17	DC04-035-17	
18.0	7	DC04-029-18	DC04-031-18			DC04-037-18

ACMA INTERNATIONAL

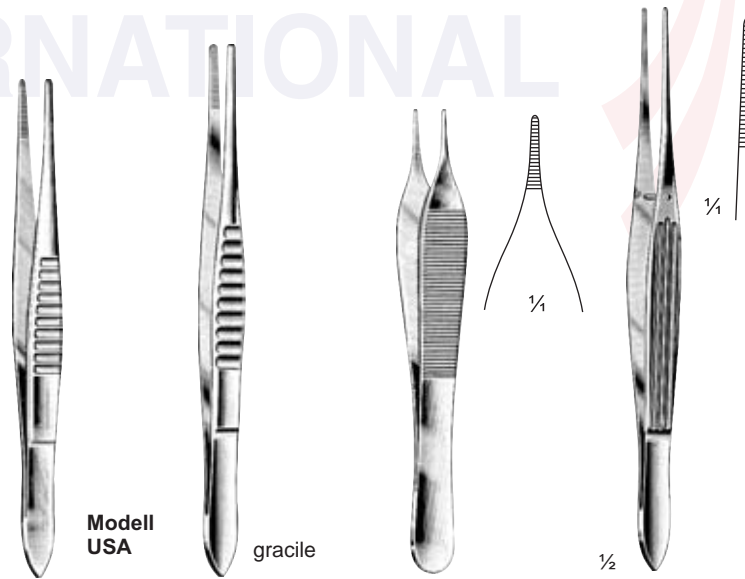

cm	in.	Standard	Adson	McIndoe
12.0	4 3/4	DC04-039-12	DC04-041-12	DC04-043-12
13.0	5	DC04-039-13	DC04-041-13	
14.5	5 1/2	DC04-039-14	DC04-041-14	
15.0	6		DC04-043-15	DC04-045-15
15.5	6	DC04-039-15	DC04-041-15	
18.0	7	DC04-039-18		
21.0	8 1/4	DC04-039-21		
25.0	10	DC04-039-25		
31.0	12 1/4	DC04-039-31		

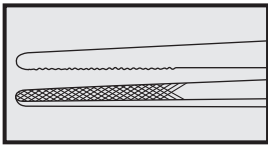

Wangensteen
DC09-047-23
23cm/9"

cm	in.	Potts-Smith		Brophy		Duehrssen
18.0	7	DC09-049-18	DC09-051-18			
20.0	8			DC09-053-20	DC09-055-20	DC09-057-20
21.0	8 ¼	DC09-049-21	DC09-051-21			
25.0	10	DC09-049-25	DC09-051-25			

Tissue Forceps

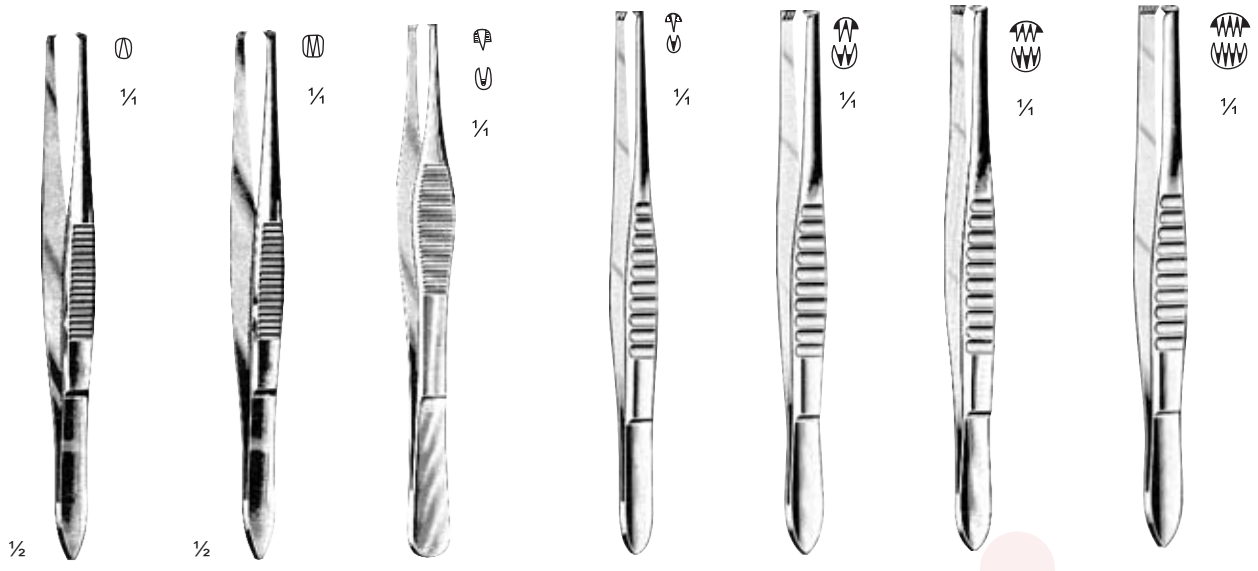
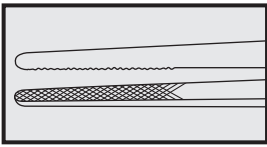

cm	in.	Stille 1:2	Stille 2:3	Mod. Martin 1:2	Mod. USA 1:2	Mod. USA 2:3	Mod. USA 3:4	Mod. USA 4:5
12.0	4 3/4				DC04-065-12			
13.0	5			DC04-063-13	DC04-065-13	DC04-067-13	DC04-069-13	DC04-071-13
14.5	5 1/2			DC04-063-14	DC04-065-14	DC04-067-14	DC04-069-14	DC04-071-14
15.0	6	DC04-059-15	DC04-061-15					
15.5	6				DC04-065-15	DC04-067-15	DC04-069-15	DC04-071-15
18.5	7 1/4				DC04-065-18			
21.0	8 1/4				DC04-065-20			
25.0	10				DC04-065-25			
31.0	12 1/4				DC04-065-30			



cm	in.	1:2	2:3	3:4	4:5	1:2	1:2	1:2
10.5	5 1/4	DC04-073-10						narrow
11.5	4 1/2	DC04-073-11	DC04-075-11					
13.5	5	DC04-073-13	DC04-075-13	DC04-077-13	DC04-079-13	DC04-081-13	DC04-083-13	DC04-085-13
14.5	5 1/2	DC04-073-14	DC04-075-14	DC04-077-14	DC04-079-14	DC04-081-14	DC04-083-14	DC04-085-14
16.0	6 1/4	DC04-073-16	DC04-075-16	DC04-077-16	DC04-079-16	DC04-081-16		
18.0	7	DC04-073-18	DC04-075-18					
20.0	8	DC04-073-20	DC04-075-20			DC04-081-20		
25.0	10	DC04-073-25	DC04-075-25					
30.0	12	DC04-073-30	DC04-075-30					

Skin Forceps, Tissue Forceps and Neurosurgical Forceps

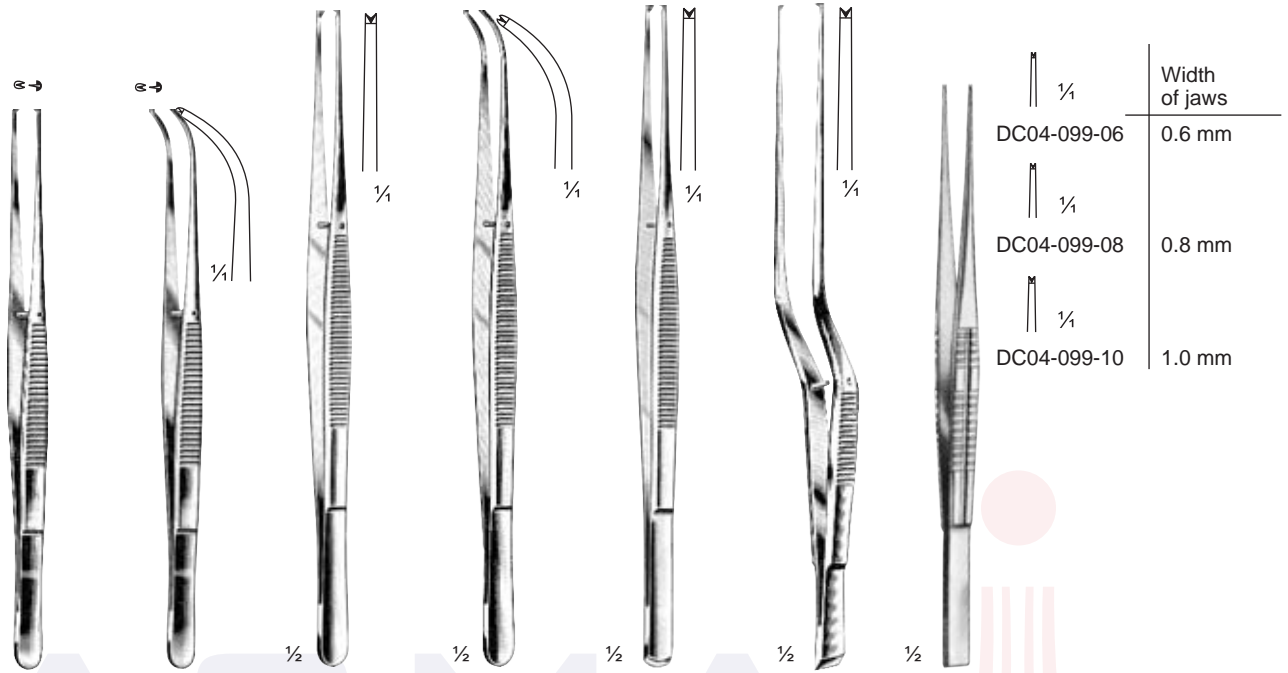
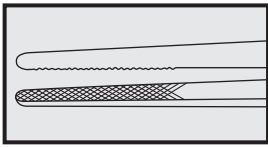

Model	Width of jaws
DC04-099-06	0.6 mm
DC04-099-08	0.8 mm
DC04-099-10	1.0 mm

cm	in.	1:2	Semken 1:2	Taylor 1:2	Taylor 1:2	Taylor 1:2	Taylor 1:2	Taylor 1:2	15cm/6"
12.5	5	DC04-087-12	DC04-089-12						
15.0	6	DC04-087-15	DC04-089-15						
17.5	7			DC04-091-17	DC04-093-17	DC04-095-17	DC04-097-17		

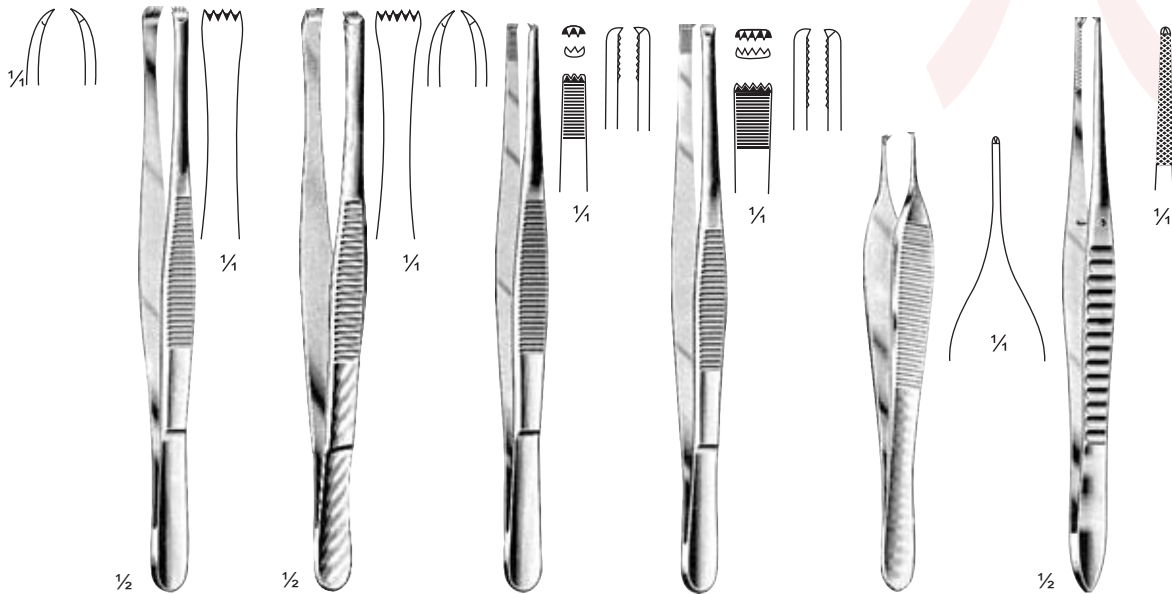

cm	in.	4:5	Stone 4:5	5:6	Lerche 5:6	2:3	Adlerkreutz 2:3	4:5	Adson 4:5	1:2	Adson 1:2	1:2	Gillies 1:2
12.0	4 3/4										DC04-109-12		
15.0	6	DC04-101-15	DC04-101-15	DC04-103-15	DC04-103-15	DC04-105-15	DC04-105-15	DC04-107-15	DC04-107-15	DC04-109-15	DC04-109-15	DC04-111-15	DC04-111-15
20.0	8					DC04-105-20	DC04-105-20	DC04-107-20	DC04-107-20				

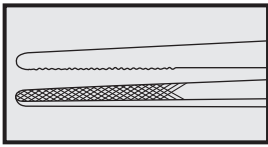

Micro & Tissue Forceps



Adson-Brown
DC04-113-12
12cm/4 3/4"
7 : 7 Teeth

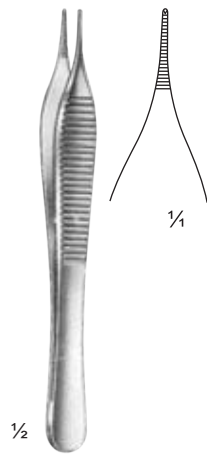

Micro-Adson
DC04-115-12
12cm/4 3/4"

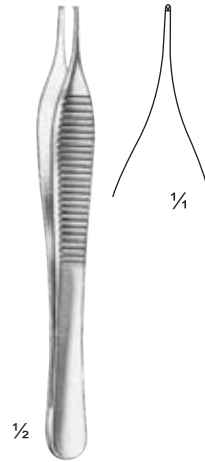

Micro-Adson
DC04-117-12
12cm/4 3/4"
1 : 2 Teeth

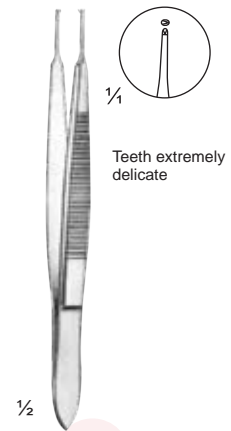

DC04-119-11
11cm/4 1/2"



cm	in.	Gerald 1:2	Gerald 1:2	Cushing 1:2	Cushing 1:2	Potts-Smith	Brophy	Brophy
17.0	6 3/4	DC04-121-17	DC04-123-17	DC04-125-17	DC04-127-17			
18.0	7					DC04-129-18	DC04-131-18	
20.0	8						DC04-133-20	DC04-135-20
21.0	8 1/4					DC04-129-21	DC04-131-21	
25.0	10					DC04-129-25	DC04-131-25	

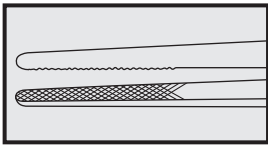

Tissue Forceps, Watchmaker's Forceps



Ferris-Smith
DC04-137-18
18 cm/7"

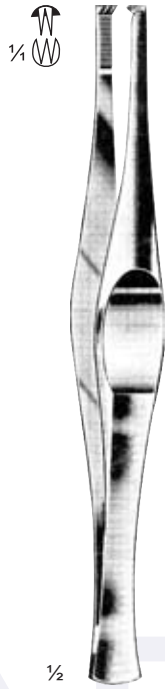

Ferris-Smith
DC04-139-18
18 cm/7"

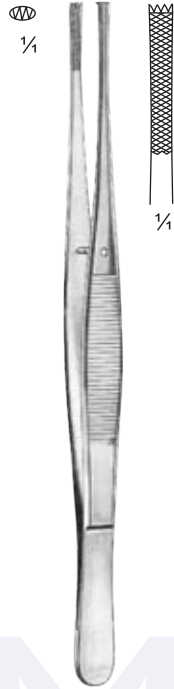

Stille-Barraya
DC04-141-18 = 18 cm/7"
DC04-141-20 = 20 cm/8"
DC04-141-25 = 25 cm/10"

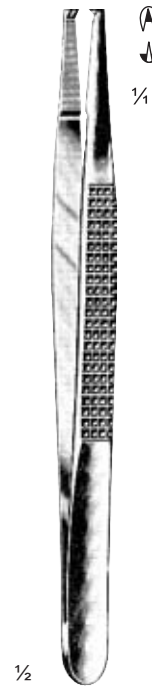

Bonney
DC04-143-18
18 cm/7"

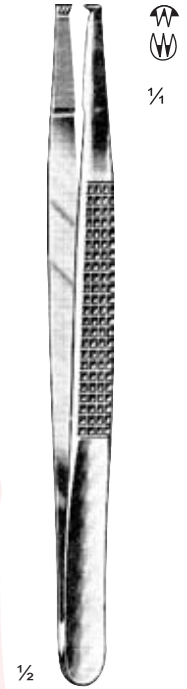

Bonney
DC04-145-18
18 cm/7"

ACMA
INTERNATIONAL



DC04-147-12
12cm/4 3/4"

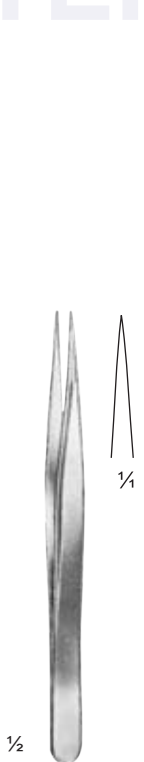

DC04-149-12
12cm/4 3/4"

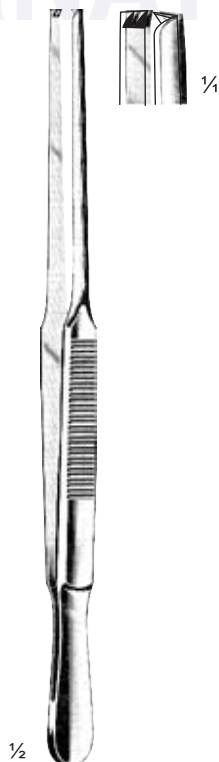

Duhrssen
DC04-151-20
20cm/8"

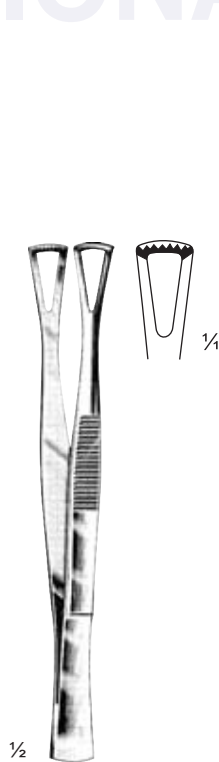

Duval
DC04-153-14
14.5cm/5 1/2"

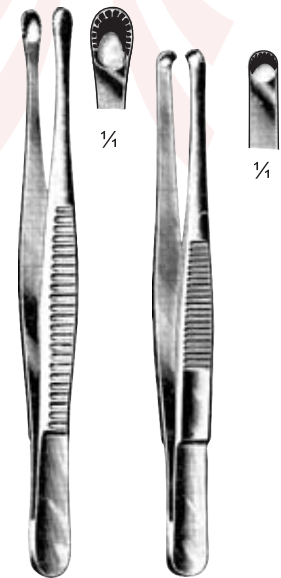

cm	in.	Russ. Modell	Durante
14.5	5 1/2		DC04-157-14
15.0	6	DC04-155-15	
16.0	6 1/4		DC04-157-16
20.0	8	DC04-155-20	DC04-157-20
25.0	10	DC04-155-25	

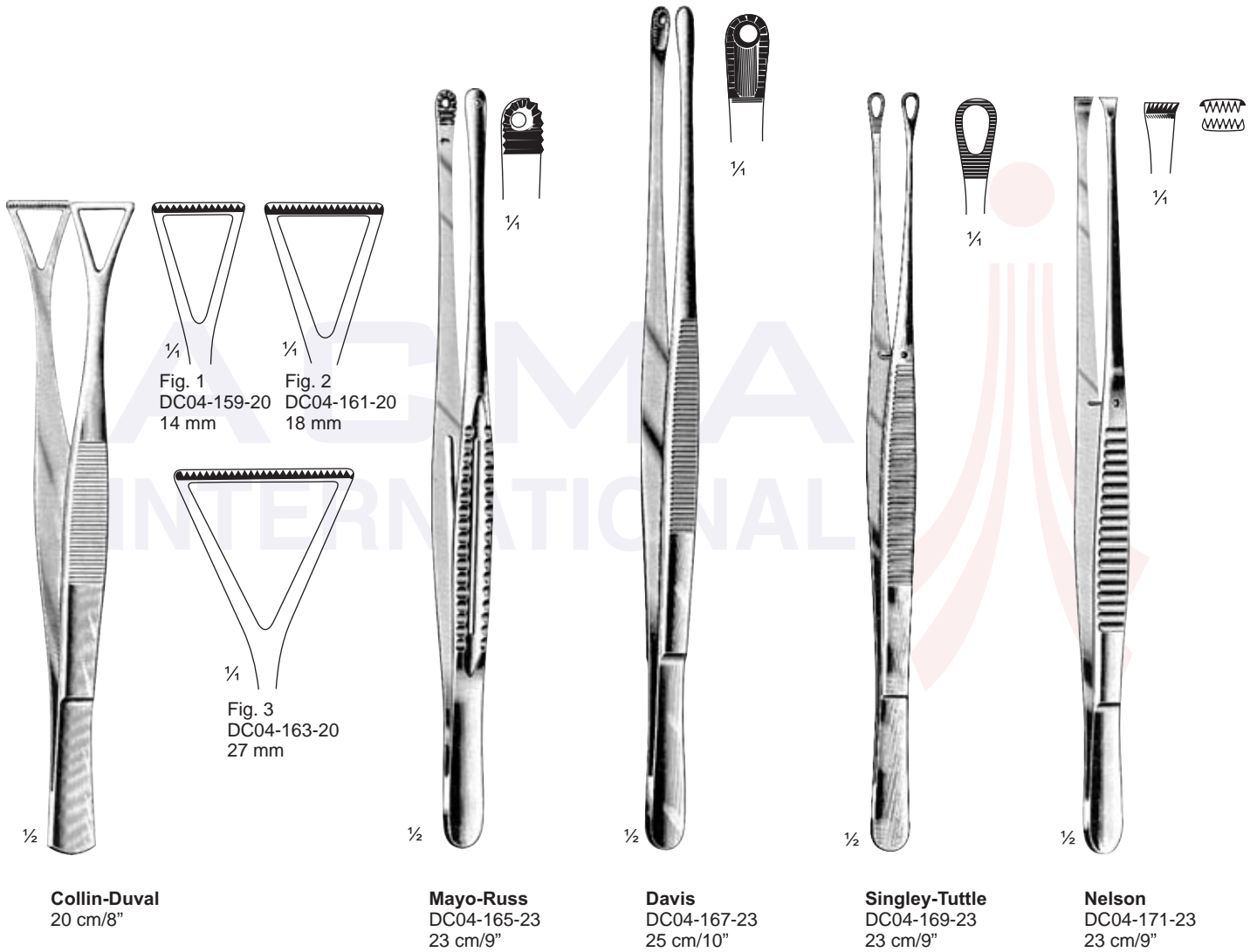
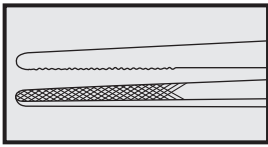

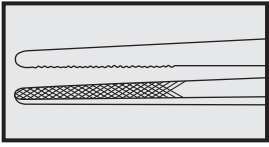

Knotting forceps

Splinter Forceps, Micro Forceps

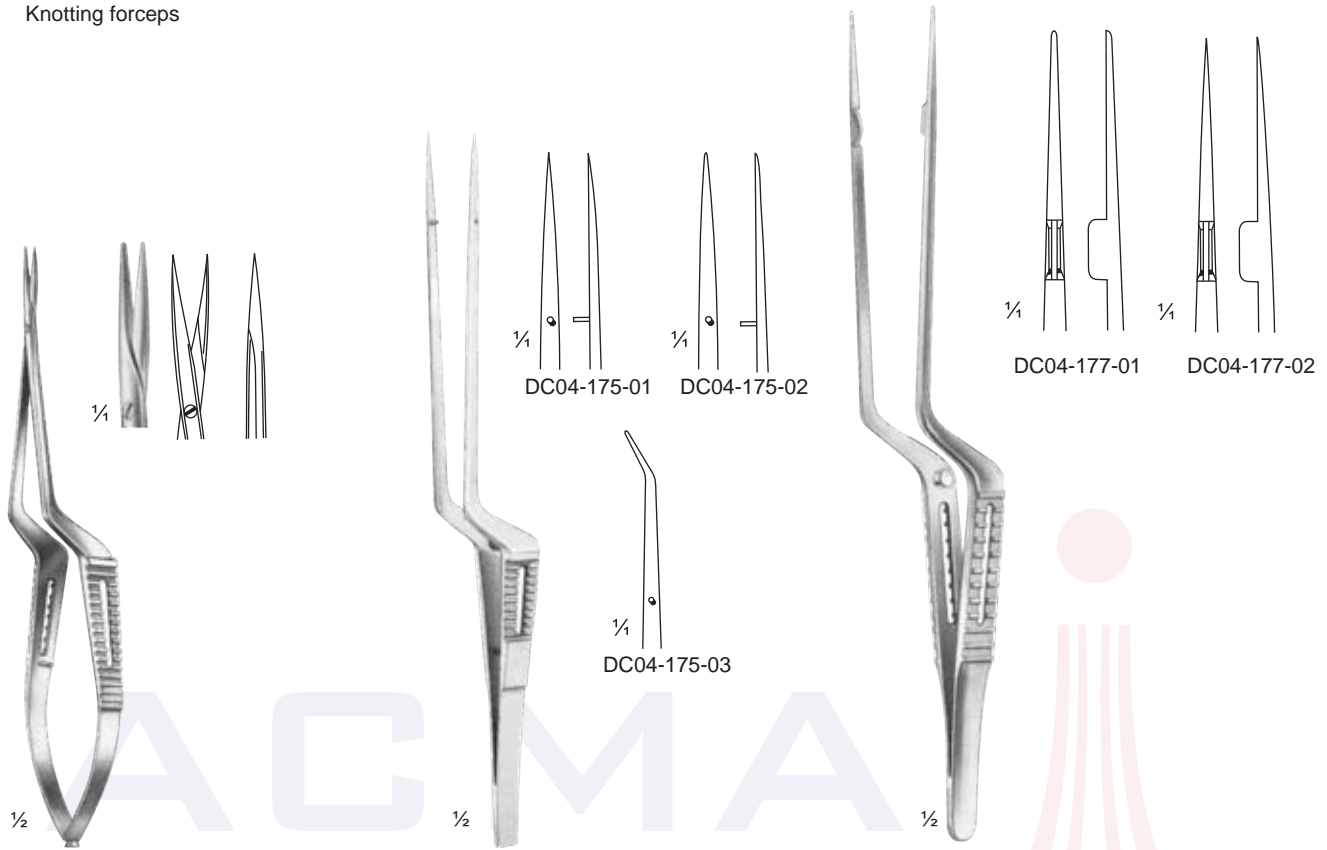

DC04-173-16
15.5 cm/6"

DC04-175-01 - 03
18.5 cm/7 1/4"

DC04-177-01 - 02
22.5 cm/9"

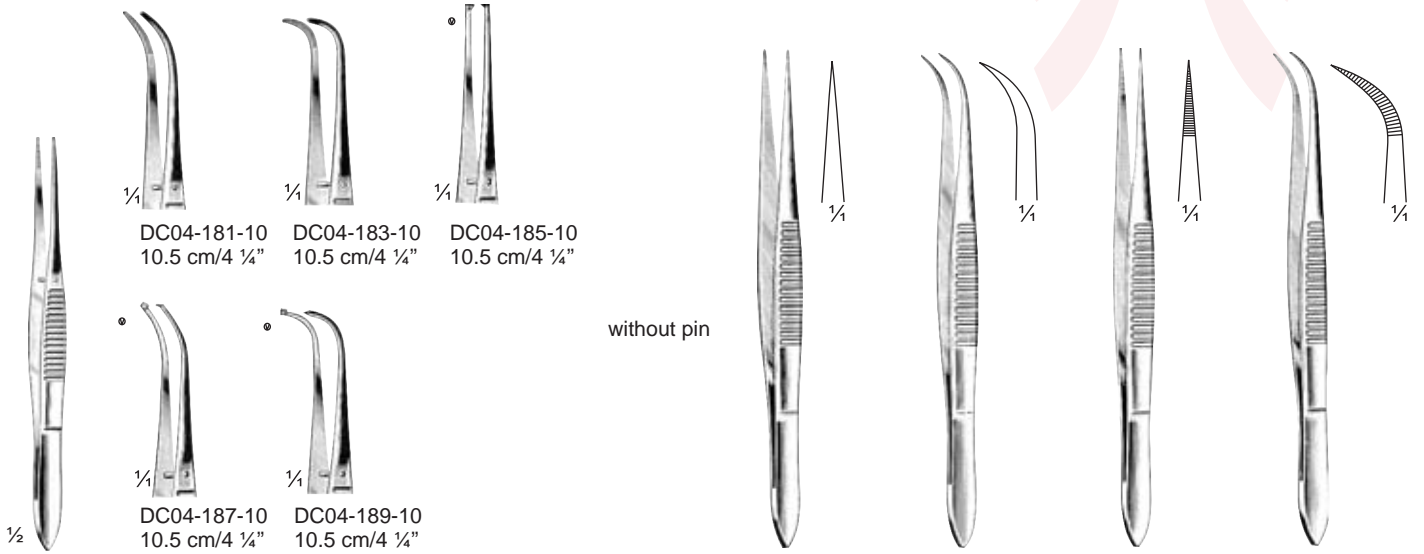

DC04-181-10
10.5 cm/4 1/4"

DC04-183-10
10.5 cm/4 1/4"

DC04-185-10
10.5 cm/4 1/4"

DC04-187-10
10.5 cm/4 1/4"

DC04-189-10
10.5 cm/4 1/4"

without pin

DC04-179-10
10.5 cm/4 1/4"

cm	in.	smooth		serrated	
8.0	3 1/4			DC04-195-08	DC04-197-08
9.0	3 1/2	DC04-191-09	DC04-193-09	DC04-195-09	DC04-197-09
10.5	4 1/4	DC04-191-10	DC04-193-10	DC04-195-10	DC04-197-10
11.5	4 1/2	DC04-191-11	DC04-193-11	DC04-195-11	DC04-197-11
12.5	5	DC04-191-12	DC04-193-12	DC04-195-12	DC04-197-12

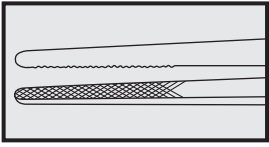

Splinter Forceps, Cilia Forceps



cm	in.	Hunter	Hunter	Walter-Carmalt		Feilchenfeld
7.5	3					DC04-211-07
9.5	3 ½					DC04-211-09
10.5	4 ¼	DC04-199-10	DC04-201-10	DC04-203-10	DC04-205-10	
11.5	4 ½					DC04-211-11
12.0	4 ¾					DC04-207-12
12.5	5					DC04-209-12

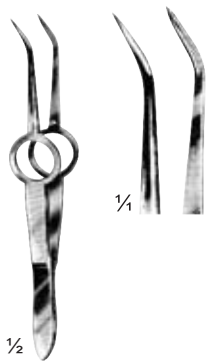

Shaaf
DC04-213-09
9 cm/3 ½"

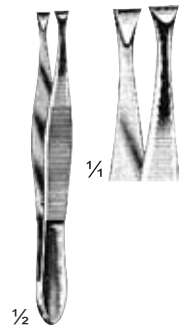

Littauer
DC04-215-08
8.5 cm/3 ½"

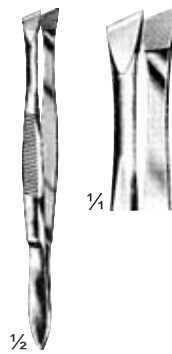

DC04-217-09
9 cm/3 ½"

Lightweight Forceps



DC04-219-10
10 cm/4"



DC04-221-10
10 cm/4"

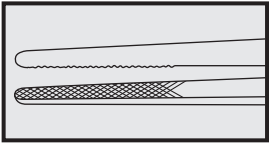

Splinter Forceps, Cilia Forceps

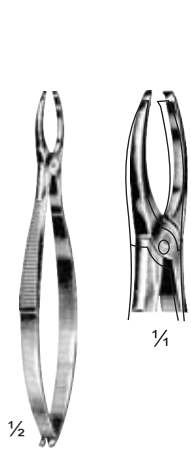

Gradle
DC04-223-09
9.5 cm/3 3/4"



Henry
DC04-225-12
12 cm/4 3/4"



Barraquer
DC04-227-10
10.5 cm/4 1/4"

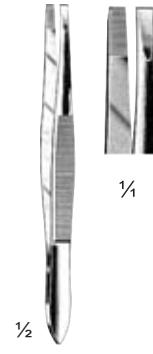

Douglas
DC04-229-09
9 cm/3 1/2"

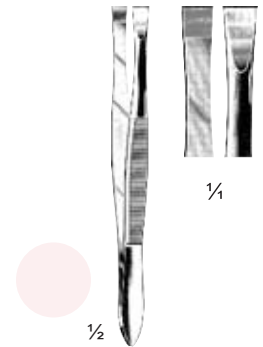

Douglas
DC04-231-09
9 cm/3 1/2"

ACMA
INTERNATIONAL

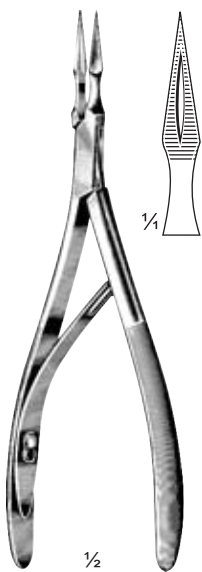

Ralk
DC04-233-15
15 cm/6"

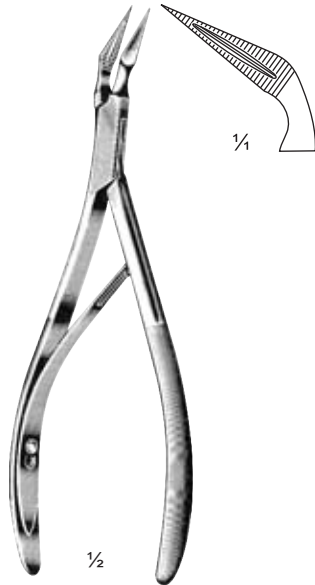

Ralk
DC04-235-15
15 cm/6"

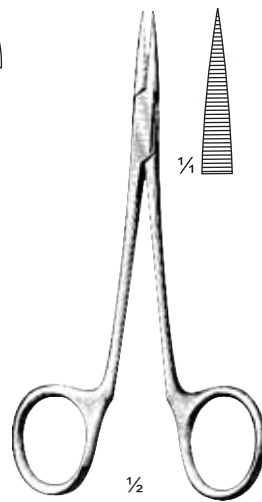

Physician
DC04-237-13
13 cm/5"

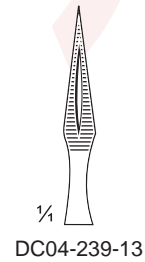

DC04-239-13

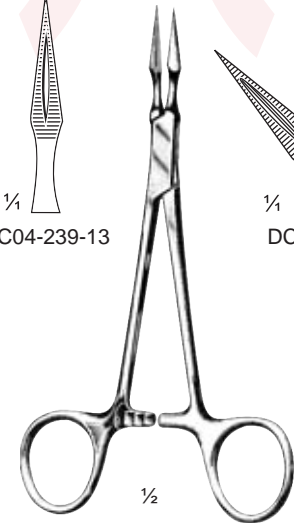

Stieglitz
13.5 cm/5 1/2"

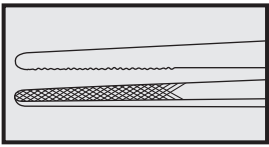

Approximation and Clip Applying Forceps

with clip holder

Ligature Carrier

with tying platform

1 x 2 teeth



Childe
DC04-243-18
18cm/7"



Childe
DC04-245-18
18cm/7"



Ochsner
DC04-247-14
14.5cm/5 3/4"

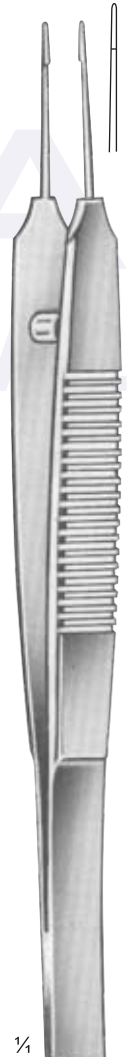

Gomel
DC04-249-14
14cm/5 1/2"



Gomel
DC04-251-14
14cm/5 1/2"

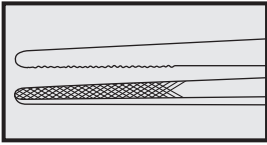

Forceps with Tungsten Carbide Inserts



Cushing-Taylor
DC04-253-18
18 cm/7"



Oehler
DC04-255-14 = 14 cm/5 1/2"
DC04-255-16 = 16 cm/6 1/2"
DC04-255-18 = 18 cm/7"
DC04-255-20 = 20 cm/8"
DC04-255-25 = 25 cm/10"
DC04-255-30 = 30 cm/12"

ACMA INTERNATIONAL

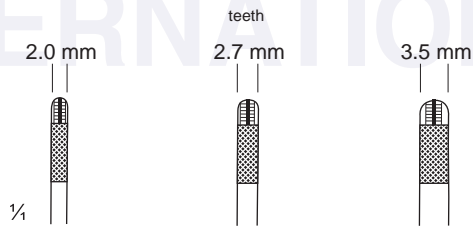

DeBakey

DC04-257-15
15cm/6"

DC04-259-20
20cm/8"

DC04-261-24
24cm/9 1/2"

DC04-263-15
15cm/6"

DC04-265-20
20cm/8"

DC04-267-24
24cm/9 1/2"

DC04-269-20
20cm/8"

DC04-271-24
24cm/9 1/2"

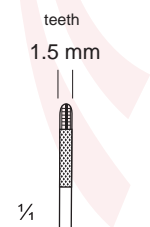

DeBakey

DC04-273-15
15cm/6"





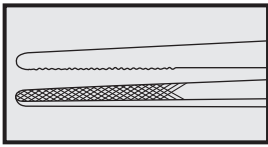

DC04-275-20
20cm/8"

DC04-277-25
25cm/10"



Forceps with Tungsten Carbide Inserts

 <p>1.8 mm ¼ DC04-279-14 14cm/5 ½"</p>  <p>DC04-279-17 17cm/6 ¾"</p>  <p>DC04-279-20 20cm/8"</p> <p>with dissector end</p> <p>Potts-Nevin</p>	 <p>1.8 mm ¼ DC04-281-18 18cm/7"</p>  <p>DC04-283-18 18cm/7"</p> <p>DC04-279-25 25cm/10"</p> <p>½ Cushing</p>	 <p>1.8 mm ¼ DC04-285-18 18cm/7"</p> <p>½ Lucae</p>	 <p>1.6 mm ¼ DC04-287-16 16cm/6 ¼"</p> <p>½ Meriam</p>
--	---	---	---

 <p>1.8 mm ¼ DC04-289-13 13cm/5"</p>  <p>DC04-291-14 14cm/5 ½"</p>  <p>DC04-293-16 16cm/6 ¼"</p> <p>DC04-295-18 18cm/7"</p> <p>DC04-297-20 20cm/8"</p> <p>DC04-299-25 25cm/10"</p> <p>Standard</p>	 <p>1.8 mm ¼ DC04-301-17 17cm/6 ¾"</p> <p>½ Potts-Smit with dissector end</p>	 <p>1.8 mm ¼ DC04-303-18 18cm/7"</p>  <p>DC04-305-20 20cm/8"</p>  <p>2.0 mm DC04-307-25 25cm/10"</p> <p>Potts-Smit with dissector end</p>
--	---	--

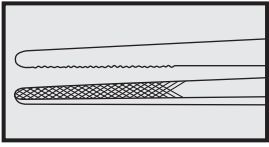

Forceps with Tungsten Carbide Inserts

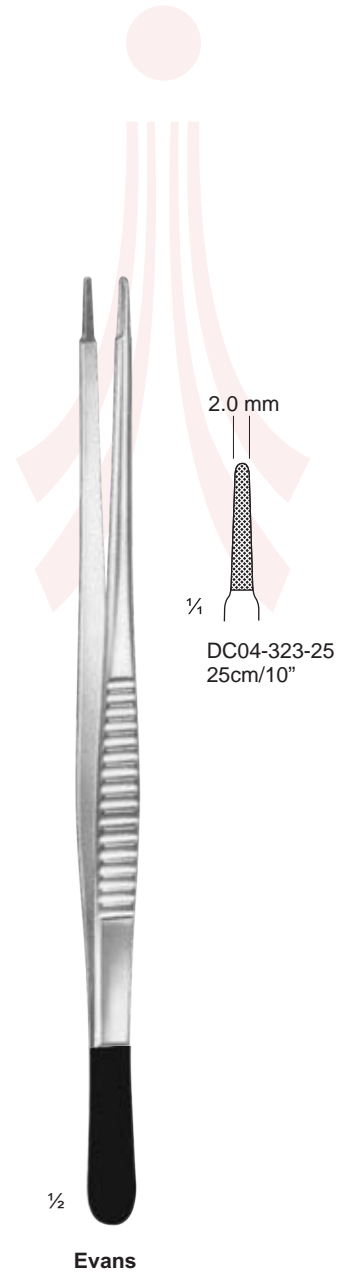
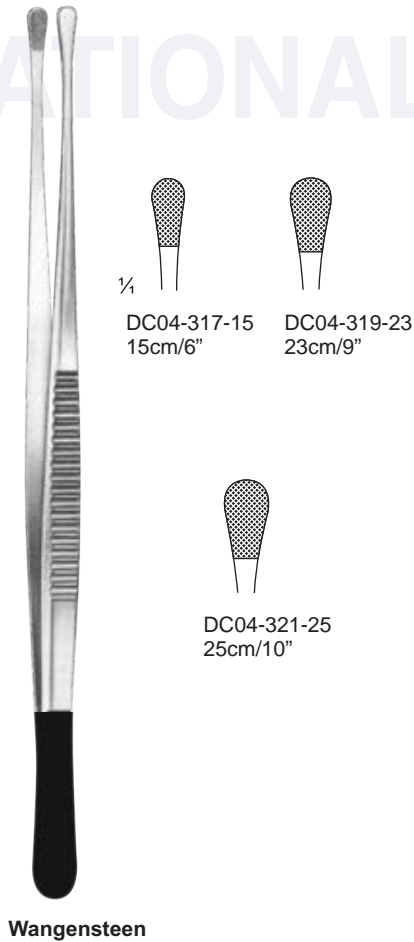
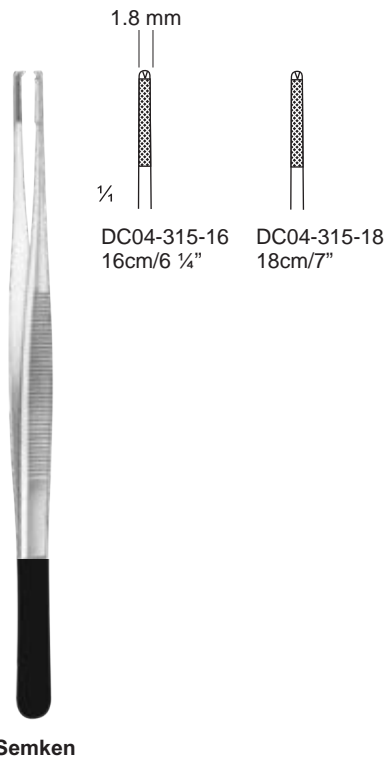
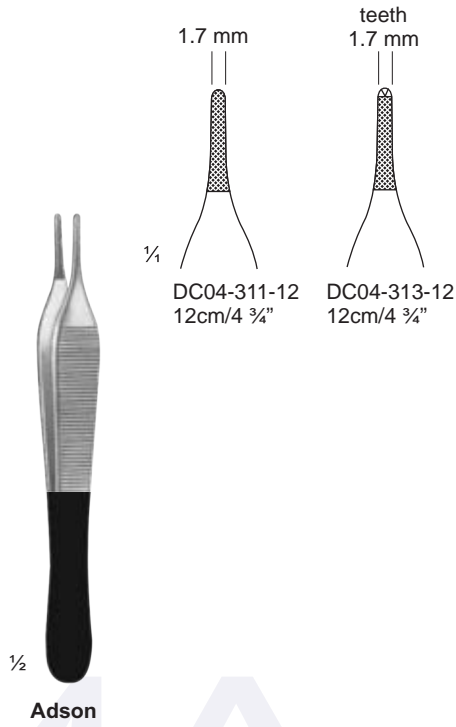
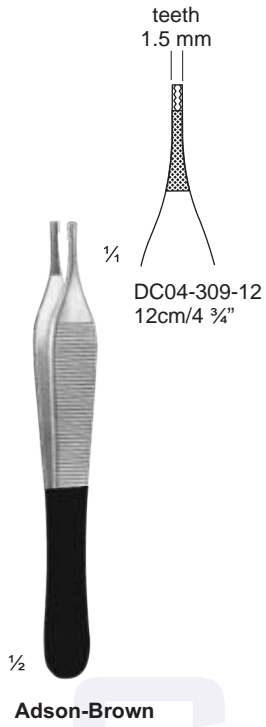

ACMA
INTERNATIONAL